



Paradise[®] Series.

2026 OWNER'S MANUAL 50 Hz



WELCOME



Watkins Wellness congratulates you on your decision to enjoy the finest spa available. Welcome to the growing family of Caldera® spa owners.

OWNER'S MANUAL

This Owner's Manual will acquaint you with the operation and general maintenance of your new spa. We suggest that you take some time to carefully review all sections. Please keep this manual available for reference.

If you have questions about any aspect of your spa's set-up, operation or maintenance, contact your authorized **CALDERA** dealership. They are trained professionals who are familiar with the product as well as new spa ownership concerns. Their expertise will facilitate the enjoyment of your new **CALDERA** spa.

The serial number/identification label is located within the equipment compartment of your **CALDERA** spa. The serial number should also be documented on the delivery receipt from your dealer.

IMPORTANT: Watkins Wellness reserves the right to change specifications, or design, without notification and without incurring any obligation.

DATE PURCHASED: _____

DATE INSTALLED: _____

DEALER: _____

ADDRESS: _____

TELEPHONE: _____

SPA MODEL/SERIAL NUMBER: _____

COVER SERIAL NUMBER: _____

MODEL: MARTINIQUE
SERIES: PARADISE
SERIAL: MRA26D119XXXX
RATINGS: 240V, 60Hz, 40A



LISTED SELF CONTAINED SPA
1280 Park Center Dr., Vista, CA 92081
Watkins Manufacturing Corp.

MRA26D119XXXX
MRA26D119XXXX
MRA26D119XXXX
MRA26D119XXXX

NOTE: This is an example. Your spa's label will contain different information. Peel off top sticker and place here.

In most cities and counties, permits will be required for the installation of electrical circuits or the construction of exterior surfaces (decks and gazebos). In addition, some communities have adopted residential barrier codes which may require fencing and/or self-closing gates on the property to prevent unsupervised access to a pool (or spa) by children under 5 years of age. Your **CALDERA** spa is equipped with a locking cover that meets the ASTM F1346-91 Standard for Safety Covers, and as a result, is usually exempt from most barrier requirements. As a general practice, your local Building Department will inform you of any applicable barrier requirements at the time a permit is obtained for the installation of an electrical circuit. Your **CALDERA** dealer can provide information on which permits may be required.

TABLE OF CONTENTS

SAFETY INFORMATION

IMPORTANT SAFETY INSTRUCTIONS.....	1
IMPORTANT SPA INSTRUCTIONS.....	3

GETTING STARTED

MAIN SPA FEATURES.....	4
HYDRO JETS.....	5
DIVERTER VALVES.....	5
WATERFALL VALVE.....	6
AIR CONTROLS.....	6
QUICK START-UP INSTRUCTIONS.....	6

WATER QUALITY AND MAINTENANCE

BASIC INFORMATION.....	8
CHEMICAL SAFETY.....	8
HOW TO ADD CHEMICALS TO THE WATER.....	8
FUNDAMENTALS OF WATER MAINTENANCE.....	9
THE CALDERA SPA WATER MAINTENANCE PROGRAM 10	
VANISHING ACT™ INSTRUCTIONS.....	11
VACATION WATER CARE INSTRUCTIONS.....	12
GLOSSARY.....	13

OPERATING INSTRUCTIONS

MAIN CONTROL PANEL.....	14
HOME SCREEN.....	15
TEMPERATURE CONTROL.....	15
LOCKING FEATURES.....	15
BRIGHTNESS.....	16
ENERGY SAVING MODE.....	16
AUTO CLEAN CYCLE.....	17
LANGUAGE.....	17
VANISHING ACT®.....	17
SOFTWARE.....	17
CLOCK SETTING.....	18
FRESHWATER® SALT SYSTEM (OPTIONAL).....	18
FRESHWATER SMART MONITORING SYSTEM (OPTIONAL).....	18
FRESHWATER DOSING SYSTEM.....	18
JETS CONTROL.....	18
LIGHT CONTROL.....	18
AUDIO CONTROL (OPTIONAL).....	19

JET MENU

MAKENA™ JET SYSTEM MENU.....	21
------------------------------	----

SALINA™ JET SYSTEM MENU.....	22
MARTINIQUE™ JET SYSTEM MENU.....	23
SEYCHELLES™ JET SYSTEM MENU.....	24
REUNION™ JET SYSTEM MENU.....	25
KAUAI™ JET SYSTEM MENU.....	26

SPA CARE AND MAINTENANCE

FILTER MAINTENANCE.....	27
FILTER CARTRIDGE REMOVAL AND CLEANING INSTRUCTIONS.....	27
VERSASSAGE JET MAINTENANCE.....	27
DRAINING YOUR SPA.....	28
PREVENTION OF FREEZING.....	28
WINTERIZING YOUR SPA.....	28
CARE OF THE SPA PILLOWS.....	29
CARE OF THE EXTERIOR.....	29
CARE OF THE SPA COVER.....	29

ELECTRICAL REQUIREMENTS

ELECTRICAL REQUIREMENTS AND PRECAUTIONS... 30	
WIRING DIAGRAMS.....	30
EQUIPMENT COMPARTMENT.....	31

INSTALLATION

SITE PREPARATION.....	32
OUTDOOR AND PATIO INSTALLATION.....	32
DECK INSTALLATION.....	32
INDOOR/BASEMENT INSTALLATION.....	32
SPA LEVELING PREPARATION.....	32
SPA COVER INSTALLATION.....	33
DELIVERY ACCESS.....	33
SPA SPECIFICATIONS.....	34

SERVICE INFORMATION

GENERAL INFORMATION.....	39
RCD AND HIGH LIMIT THERMOSTAT.....	39
HEATER AND INTEGRATED PRESSURE SWITCH.....	39
CIRCULATION PUMP AND CIRCULATION PUMP THERMAL CUT-OFF.....	39
MISCELLANEOUS SERVICE INFORMATION.....	39
ACTS INVALIDATING WARRANTY.....	40
DISCLAIMERS.....	40
CUSTOMER SERVICE.....	40
TROUBLESHOOTING.....	40
DOOR PANEL INSTRUCTIONS.....	42

SAFETY INFORMATION

IMPORTANT SAFETY INSTRUCTIONS

(READ AND FOLLOW ALL INSTRUCTIONS)

AVOIDING THE RISK TO CHILDREN

DANGER - RISK OF CHILD DROWNING

Extreme caution must be exercised to prevent unauthorized access by children. To avoid accidents, ensure that children cannot use a spa unless they are supervised at all times.

WARNING

To reduce the risk of injury, do not permit children to use this spa unless they are closely supervised at all times.

- To reduce the risk of injury, do not permit children to use this spa unless they are closely supervised at all times.
- To reduce the risk of injury, lower water temperatures are recommended for young children. Children are especially sensitive to hot water.
- The device should not be used by persons (including children) with reduced physical, sensory or mental capabilities, or lack of experience and knowledge, unless they receive supervision or training.

DO:

- Make sure you always lock the child resistant locks after using the spa for your children's safety. Every **CALDERA** spa is equipped with a locking cover that meets the ASTM F1346-91 Standard for Safety Covers.
- Test the water temperature with your hand before allowing children to enter the spa to be sure that it's comfortable. Children are especially sensitive to hot water.
- Remind children that wet surfaces can be very slippery. Make sure that children are careful when entering or exiting the spa.

DON'T:

- Allow children to climb onto the spa cover.
- Allow children to have unsupervised access to the spa.

AVOIDING THE RISK OF ELECTROCUTION

DANGER - RISK OF ELECTROCUTION

- Connect only to a grounded source.
- Do not bury the power cord. A buried power cord may result in death, or serious personal injury due to electrocution if direct burial-type cable is not used, or if improper digging occurs.
- A ground terminal (pressure wire connector) is provided on the control box inside the unit to permit connection of a minimum 10 mm² solid copper bonding conductor between this point and any metal equipment, metal water pipe, metal enclosures of electrical

equipment, or conduit within 1.5 m (5') of the unit as needed to comply with local requirements.

- Do not operate the main audio/video button controls on any external media devices such as a CD or DVD player while inside in the spa. Operation of integrated audio/video equipment through the spa control panel or wireless remote is permitted and acceptable.
- Do not connect any auxiliary components (for example, cable additional speakers, headphones, additional audio components) to the audio system unless approved by Watkins Wellness .
- Do not self service audio component by opening spa door as this may expose dangerous voltage or other risk of injury. Refer all servicing to qualified service personnel.
- Do not attach an external antennae to a spa audio system unless installed by a licensed electrician in accordance with National Electric Code.

WARNING

- To reduce the risk of electrical shock, replace a damaged cord immediately. Failure to do so may result in death or serious personal injury due to electrocution.
- In order to avoid a hazard due to inadvertent resetting of the thermal cut-out, this appliance must not be supplied through an external switching device, such as a timer, or connected to a circuit that is regularly switched on and off by the utility.
- Always test the residual current device (RCD) before each use of the spa. If the RCD does not perform properly, a ground current is flowing indication the possibility of electric shock. Disconnect power to the spa until the fault has been identified and corrected.
- **NOTE:** Failure to wait 30 seconds before resetting the RCD may cause the spa's Power Indicator (on the control panel) to blink. If this occurs, repeat the RCD test procedure.
- Your spa must be supplied by a residual current device with a tripping rating not exceeding 30 mA in an electrical subpanel.

DANGER - RISK OF ELECTRICAL SHOCK

- Install spa at least 1.5 m (5') from all metal surfaces. A spa may be installed within 1.5 m (5') of a metal surface if each metal surface is permanently connected by a minimum 10 mm² solid copper conductor attached to the wire ground connector on the terminal box that is provided for this purpose.
- Do not permit any electrical appliances, such as a light, telephone, radio, or television within 1.5 m (5') of a spa. Failure to maintain a safe distance may result in death, or serious personal injury due to electrocution, if the appliance should fall into the spa.
- Install your spa in such a way that drainage is away from the electrical compartment and from all electrical components.

DO:

- Be sure your spa is connected to the power supply correctly - use a licensed electrical contractor.
- Disconnect the spa from the power supply before draining the spa or servicing the electrical components.
- Test the RCD before each use.
- Replace audio components only with identical components (if your spa is equipped with an audio component).

DON'T:

- Use the spa with the equipment compartment door removed.
- Place electrical appliances within 1.5 m (5') of the spa.
- Use an extension cord to connect the spa to its power source. The cord may not be properly grounded and the connection is a shock hazard. An extension cord may cause a voltage drop, which will cause overheating of the jet pump motor and motor damage.
- Attempt to open the electrical control box. There are no user serviceable parts inside.

RISKS TO AVOID

DANGER - RISK OF INJURY

- To reduce the risk of injury to persons, DO NOT remove suction fittings (filter standpipes) located in the filter compartment.
- The suction fittings in the spa are sized to match the specific water flow created by the pump. Never replace a suction fitting with one rated less than the flow rate marked on the original suction fitting.
- There is a danger of slipping and falling. Remember that wet surfaces can be very slippery. Take care when entering or exiting the spa.
- Never operate spa if the suction fittings are broken or missing.
- People with infectious diseases should not use the spa.
- Keep any loose articles of clothing, long hair, or hanging jewelry away from rotating jets or other moving components.

INCREASED SIDE EFFECTS OF MEDICATION

- The use of drugs, alcohol may cause unconsciousness with the possibility of drowning.
- Persons using medications should consult a physician before using a spa; some medication may cause a user to become drowsy, while other medication may affect heart rate, blood pressure, and circulation.
- Persons taking medications which induce drowsiness, such as tranquilizers, antihistamines, or anticoagulants should not use the spa.

HEALTH PROBLEMS AFFECTED BY SPA USE

- Pregnant women should consult a physician before using spa.
- Persons suffering from obesity, or with a medical history of heart disease, low or high blood pressure, circulatory system problems, or diabetes should consult a physician before using spa.

UNCLEAN WATER

- Keep the water clean and sanitized with correct chemical care. The recommended levels for your **CALDERA** spa are:

Free Available Chlorine: 1 - 5 ppm	Total Alkalinity: 40 - 120 ppm
Water pH: 7.2 - 7.8	Calcium Hardness: Standard 75 - 150 ppm Salt System 25 - 75 ppm

- Refer to Water Quality and Maintenance section for complete instructions.

IMPORTANT: Turn on the jet pump for a least ten minutes after adding ANY spa water chemicals into the filter compartment.

Clean the filter cartridges monthly to remove debris and mineral buildup which may affect the performance of the hydromassage jets, limit the flow, or trip the high limit thermostat, which will turn off the entire spa.

AVOIDING THE RISK OF HYPERTHERMIA

Prolonged immersion in hot water can result in HYPERTHERMIA, a dangerous condition which occurs when the internal temperature of the body reaches a level above normal 37°C (98.6°F). The symptoms of hyperthermia include unawareness of impending hazard, failure to perceive heat, failure to recognize the need to exit the spa, physical inability to exit the spa, fetal damage in pregnant women, and unconsciousness resulting in a danger of drowning.

WARNING

The use of alcohol, drugs, or medication can greatly increase the risk of fatal hyperthermia in hot tubs and spas.

TO REDUCE THE RISK OF INJURY

- The water in the spa should never exceed 40°C (104°F). Water temperatures between 36°C and 40°C (97°F and 104°F) are considered safe for a healthy adult. Lower water temperatures are recommended for extended use (exceeding ten minutes) and for young children. Extended use can cause hyperthermia.
- Pregnant or possibly pregnant women should limit spa water temperatures to 36°C (100°F). Failure to do so may result in permanent injury to your baby.
- Do not use spa immediately following strenuous exercise.

AVOIDING THE RISK OF SKIN BURNS

- To reduce the risk of injury, before entering a spa the user should measure the water temperature with an accurate thermometer.
- Test the water with your hand before entering the spa to be sure it's comfortable.

SAFETY SIGN

Each **CALDERA** spa is shipped with a SAFETY SIGN in the owner's package. The sign, which is required as a condition of Product Listing, should be permanently installed where it is visible to the users of the spa. To obtain additional SAFETY SIGNS, contact your **CALDERA** dealer and request Part #70798.

IMPORTANT SPA INSTRUCTIONS

The following contains important spa information, and we strongly encourage you to read and apply them.

DO:

- Use and lock the cover when the spa is not in use, whether it is empty or full.
- Follow the Spa Care and Maintenance recommendations stated in this manual.
- Use only approved accessories and recommended spa chemicals and cleaners.

DON'T:

- Leave the **CALDERA** spa exposed to the sun without water or the cover in place. Exposure to direct sunlight can cause solar distress of the shell material.
- Roll or slide the spa on its side. This will damage the siding.
- Lift or drag the cover by using the cover lock straps; always lift or carry the cover by using the handles.
- Attempt to open the electrical control box. There are no user serviceable parts inside. Opening of the control box by the spa owner will void the warranty. If you have an operational problem, carefully go through the steps outlined in the Troubleshooting section. If you are not able to resolve the problem, contact your authorized **CALDERA** dealer. Many problems can easily be diagnosed over the telephone by an Authorized Service Technician.

SPA SHELL

Your **CALDERA** spa has an acrylic shell. Stains and dirt generally will not adhere to your spa's surface. A soft rag should easily remove most dirt. Most household chemicals are harmful to your spa's shell (see below for detailed information on cleaning agents). Always rinse off any spa shell cleaning agent with fresh water.

IMPORTANT:

1. The following products are the **ONLY** approved cleaning agents for your **CALDERA** spa shell: plain water, Brilliantize[®] or Soft Scrub[®]. The use of alcohol or any other household cleaner other than those listed to clean the spa shell surface is **NOT** recommended. **DO NOT** use any cleaning products containing abrasives or solvents since they may damage the shell surface, specifically: Simple Green[®], Windex[®] or Spa Mitt. **NEVER USE HARSH CHEMICALS!** Damage to the shell by use of harsh chemicals is not covered under the warranty. Always rinse off any spa shell cleaning agent with fresh water.
2. Iron and copper in the water can stain the spa shell if allowed to go unchecked. Ask your **CALDERA** dealer about a Stain and Scale Inhibitor to use if your spa has a high concentration of dissolved minerals. (Watkins recommends **FRESHWATER** Stain & Scale Defense.)
3. Keep all cleaners out of the reach of children and use care when applying.

SAVE THESE INSTRUCTIONS

GETTING STARTED

MAIN SPA FEATURES

The illustrated spa may look different than yours.



1) The **Main control panel** provides a quick visual check of the spa's status and allows the user to set different functions of the spa.



2) The **Diverter** system lets you divert water to different combinations of jets simply by turning the lever.



3) The **Air Valve** lever lets you dial in the ideal amount of air for your jets.



4) The **Water Feature Lever** adjusts the amount of water that flows from the water feature.



5) The **AdaptaSsage™** jet provides a rotating massage pattern.



6) The **AdaptaFlo™** jet allow you to redirect the jet stream by changing the position of the nozzle.



7) The **Euro Directional** jets, with eyeball nozzles, deliver a direct, more focused massage.



8) The **Euro-Pulse™** (**KAUAI** model only) jets feature a special insert that creates a soft, pulsating, rotary massage.



9) The **VersaSsage™** jet may be adjusted to provide either a stationary, direct stream or, by positioning the nozzle to one side or the other, a rotating jet stream.



10) The **Euphoria™** jet provides a deep, powerful, penetrating massage to your thighs, knees, calves, and feet.



11) **FRESHWATER** Salt System housing cap.



12) **FRESHWATER** Smart Monitoring system housing cap.



ADDITIONAL SPA FEATURES

13) Water feature

14) 9 cm Speaker (Optional)

15) Pillow

16) Ozone Jet/Heater Return

17) Suction Screen

18) Grab Rail

19) Filter Compartment Lid

HYDRO JETS

ADAPTAFLO Jets - These jets allow you to redirect the jet stream by changing the position of the nozzle.

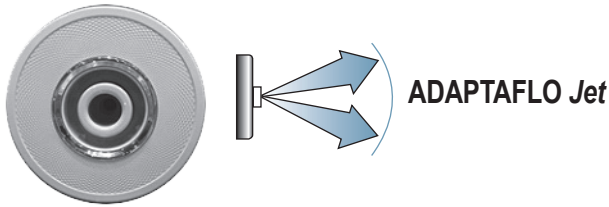

ADAPTASSAGE Jets - These jets provide a rotating massage pattern.

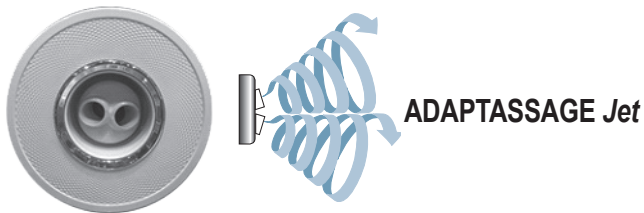

The face plates in the **ADAPTAFLO** jets and the **ADAPTASSAGE** jets are interchangeable. To remove a **ADAPTASSAGE** face plate, turn it counter-clockwise until it stops turning. Turn the face once more until you hear a clicking noise, push it in, and then pull it straight off. Install the face plate by snapping it into place. Additional **ADAPTASSAGE** dual-port nozzles are available from your **CALDERA** dealer.

Both the **ADAPTAFLO** and **ADAPTASSAGE** jets allow you to regulate the force of the massage. Rotate the fascia ring to reduce or increase the force. Notice that turning off the flow to some jets increases the flow to the other jets. To avoid damage to your spa's plumbing and components, do not turn off more than half of these jets at the same time.

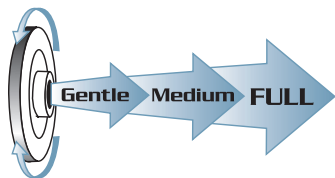

EURO DIRECTIONAL - The Euro Directional jets, with eyeball nozzles, deliver a direct, more focused massage.

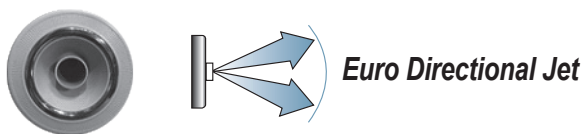

EURO-PULSE Jets - The **EURO-PULSE** jets feature a special insert that creates a soft, pulsating, rotary massage.

NOTE: Please do not attempt to rotate the jet face on either the Euro Directional, or **EURO-PULSE** as these jets do not regulate the force of the massage.



VERSASSAGE Jets - These jets may be adjusted to provide either a stationary, direct stream or, by positioning the nozzle to one side or the other, a rotating jet stream.

The **VERSASSAGE** jets allow you to regulate the force of the massage. Rotate the fascia ring counter-clockwise to reduce the force, or clockwise to increase the force. Notice that turning off the flow to some jets increases the flow to the other jets. To avoid damage to your spa's plumbing and components, do not turn off more than half of these jets at the same time. For cleaning instructions, see the **VERSASSAGE** Jets Maintenance section.

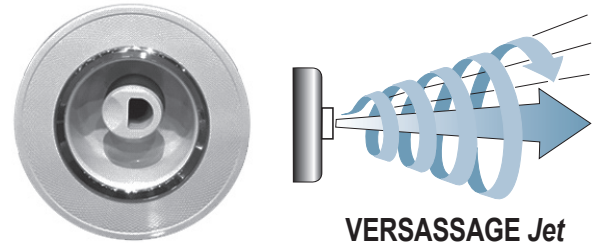

EUPHORIA Jet

(MAKENA, SALINA, SEYCHELLES & REUNION spas only) - The **EUPHORIA** jet provides a deep powerful, penetrating massage to your tired feet, calves, knees and thighs.

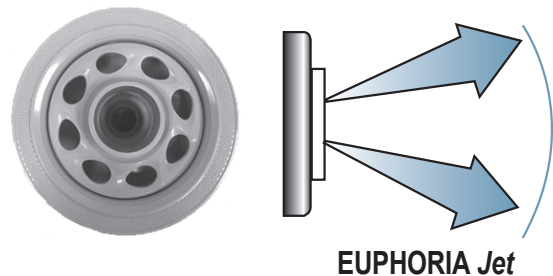

DIVERTER VALVES

The diverter valves on your spa allow you to direct the flow of water from the pumps to various combinations of jets. The functions of these diverter valves can best be learned by experimentation as follows:

Set all air controls to the "ON" position.

Turn on both pumps.

Turn the handle on each diverter valve and see which groups of jets are affected. (Note that you can adjust the diverter valves to any position between the two possible extremes to achieve the jet pressure that feels best to you.)

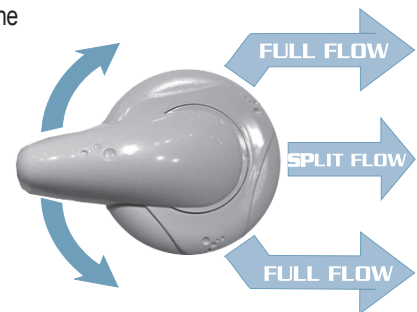

IMPORTANT: Your spa is not designed to provide full power to all jets when the diverter valves are in the "mid" position. However, with the diverter valve in this position, you may increase the power to selected jets by rotating the face of the **ADAPTAFLO** and **ADAPTASSAGE** jets to close the ones that are not in use.

TIP: Turn both pumps on and place the diverter valves to the "Mid-Position". Then experiment with each of the air controls to see their effect.

WATERFALL VALVE

The **SALINA, MAKENA, MARTINIQUE, SEYCHELLES & REUNION** spas are equipped with a cascading waterfall feature. It is activated by pressing the "JETS" button and turning the valve located on the front interior wall counterclockwise. The flow is regulated by turning the waterfall valve to the desired position.



AIR CONTROLS

Each jet system has its own air control. These allow you to change the power of the jets by regulating the amount of air that is mixed with the water coming out of the jets.

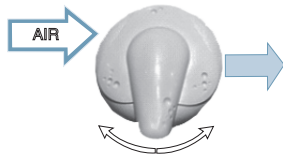

QUICK START-UP INSTRUCTIONS

BEFORE YOU FILL YOUR SPA

Make sure your spa has been properly installed per all local codes, this includes the location of the spa, the foundation of the spa as well as the electrical installation of the spa. Installation instructions in the form of a Pre-Delivery Instruction booklet can be obtained from either your **CALDERA** dealer or online.

DO:

- Know which water treatment system you will be using and make sure you have necessary chemicals available. Read all of the instructions that come with the system.
- Have **FRESHWATER** 5-way Test Strips Available.
- Have **FRESHWATER** Salt Test Strips Available if using the Salt system.
- Have pH/Alkalinity Up & Down available.
- Know the "Hardness" of your water, contact your dealer to help you with this information. See Water Quality and Maintenance for more information.
IMPORTANT: The spa can be filled with "softened" water as long as the calcium hardness parameters (pg. 2) are maintained.
- Purchase the Clean Screen™ pre-filter to remove unwanted contaminants from the tap water. This is recommended, not required.

DON'T:

- Power up the spa until it has been filled with water! Power to the spa automatically activates critical components within the spa, such as controls, heater, circulation pump, and other systems. If power is supplied to these components prior to the spa being filled, the components will be damaged, and this may result in a non-warranty component failure.
- Fill the spa with hot water or cold water with the cold water temperature below 10° C (50° F)! Tripping of the high-limit thermostat may result causing your spa to stop functioning.

START-UP

Your **CALDERA** spa has been thoroughly tested during the manufacturing process to ensure reliability and long-term customer satisfaction. A small amount of water may have remained in the plumbing after testing and, as a result, may have spotted the spa shell or the spa siding prior to delivery. Before filling the spa, wipe the spa shell clean with a soft rag. The following instructions must be read and followed exactly to ensure a successful start-up or refill.

CAUTIONS

- **Do NOT fill the spa with hot water**, as tripping of the high-limit thermostat may result.
- **DO NOT CONNECT POWER TO AN EMPTY SPA.** Power to the spa automatically activates critical components within the spa, such as controls, heater, and other systems. If power is supplied to these components prior to the spa being filled, the components will be damaged, and this may result in a non-warranty component failure.
- **DO NOT** use your spa after filling until all of the steps listed below are completed.
- **DO NOT** add chlorine if treating your spa with polyhexamethylene biguanide (Biguanide, PHMB, eg. BaquaSpa®) sanitizer.
- Before filling your spa for the first time, remove the equipment compartment door and check to ensure that the unions on either side of the pump(s) and heater are hand-tight.

Door Panel Removal - see inside back cover:

- a. Remove the 2 screws on the bottom of each corner.
- b. Find notches in bottom of panel, place fingers on one side and center notch. Slightly pull on bottom side panel to release 1st clip. Move over to other side and center notch and pull on bottom to release 2nd clip, then lower and remove panel.

1. **CLOSE DRAIN, remove the filter compartment cover, skimmer basket, weir, and filter.** Fill your spa through the filter compartment using the **CLEANSCREEN** pre-filter that attaches to your garden hose. The water level of your spa should be maintained at a level 2.5 cm above the highest jet in the spa. Reinstall the filter and then the skimmer basket, and weir once the spa is filled.

2. **AFTER THE SPA HAS BEEN FILLED** with water and the equipment compartment door is secured, power must be applied to the spa.

- **FIRST** activate power to the subpanel from the main house panel.
- **NEXT** open the door of the electrical subpanel and reset the RCD breaker.
- **FINALLY**, close and secure the subpanel door.

3. **TO CHECK THE OPERATION OF THE JET SYSTEM** and to purge any remaining air from the heating system complete the following steps:

- Press the soft button next to **Jet Max** to place both jet pumps on High.
- Once the jet system is fully operational (as indicated by strong, non-surgingly jets), priming of the spa is complete
- To turn off the jets, press the soft button next to **All Off** on the home screen to turn all functions off simultaneously
- If you do not feel a steady stream of water from your jets, refer to the instructions for priming the pump in the SPA TROUBLESHOOTING section.

IMPORTANT: Be sure that the diverter is in the middle position.

4. **SET THE TEMPERATURE CONTROL** to the desired temperature between 38°C (100°F) and 40°C (104°F), then place the spa cover on the spa and allow the water temperature to stabilize (approximately 24 hours). Make sure you secure the cover in place using the cover locks. Periodically check the spa water temperature. When the water temperature climbs above 32°C (90°F), proceed to the next step. The spa temperature is pre-programmed to reach 38°C (100°F), and will normally do so within 18 to 24 hours. You may change the water temperature by pressing the OPTION hard button then press the soft button next to **Temperature**, (press soft button next to ▲ on the control panel to raise the temperature, or lower temperature by pressing soft button next to ▼). After a few hours, the water temperature will remain within 1.5°C (3°F) of your selected temperature.

5. **USING A TEST STRIP AND APPLICABLE CHEMICALS** adjust Total Alkalinity (TA) to 80 ppm, Calcium Hardness (CH) between **75 - 150 ppm** (if using **Salt System** between **25 - 75 ppm**), then spa water pH to between 7.4 and 7.8. These procedures are listed in the "Water Quality and Maintenance" section.

OPERATION NOTE: *Adjusting the Total Alkalinity as the first step is important, as out-of balance TA will affect your ability to adjust the pH correctly and will prevent the sanitizer from operating effectively.*

When using the FRESHWATER Salt system the Calcium Hardness must be between 25 - 75 ppm, if hardness is above 75 ppm use VANISHING ACT (see pg. 11).

IMPORTANT: *Activate the Clean cycle (Press the soft button next to CLEAN on the home screen) before adding spa water chemicals directly into the filter compartment. Make sure all diverter valves are set to the middle position.*

6. **SUPERCHLORINATE THE SPA WATER** by adding 1½ teaspoons of **FRESHWATER** chlorine (sodium dichlor) per 950 liters (250 gallons) of spa water, then activate the Clean cycle.

7. **TEST THE SPA WATER FOR CHLORINE RESIDUAL.** If the residual is between 1 and 5 ppm on the test strips, go on to the next step. If the residual is less than 1 ppm, activate the Clean cycle, and then retest, add more chlorine as necessary.

WARNING: *High sanitizer levels can cause discomfort to the user's eyes, lungs and skin. Always allow the sanitizer level to fall to the recommended range before using the spa.*

8. **RECHECK** the Total Alkalinity (TA) 40 - 120 ppm, Calcium Hardness (CH) 75 - 150 ppm (25 - 75 ppm with salt), then spa water pH between 7.2 and 7.8.

OPERATION NOTE: *Make sure you adjust your Total Alkalinity and pH correctly, this will affect the sanitizers effectiveness.*

The spa is ready for use when the spa water has circulated and the chlorine level remains between 1 and 5 ppm.

OPERATION NOTE: For proper water circulation during the ten-minute Clean cycle the following steps should be performed.

- Place the diverter valve in the middle (split flow) position
- Place air control levers in OFF position by rotating clockwise

WATER QUALITY AND MAINTENANCE

BASIC INFORMATION

It's important to have clean water. Water maintenance is one of the least understood, yet most important, areas of spa ownership. Your dealer can guide you through the process of achieving and maintaining balanced water in your spa, given your local conditions.

IMPORTANT: Water Terminology can be found at the end of this section.

- **Always read & refer to the owner's manual** for complete information.
- **Test your water** with a test strip once a week, or each time the spa is used.
- **Add chemicals** in frequent small amounts to prevent overdosing the spa.
- **When using a Salt System or Smart Monitoring System**, read & refer to separate owner's manual.
- **Use the spa only** when the chlorine level is between 1-5 ppm or manually add chlorine as needed.
- **It is the spa owner's responsibility** to prevent over or under chlorination.

IMPORTANT: Remember to change your water every three to four months. Check with your **CALDERA** dealer to determine if water in your region has unique qualities - such as high metal or mineral content - that should be addressed.

Your program will depend on your water's mineral content, how often you use your spa, and how many people use it.

WATER QUALITY CHART

PARAMETER	TARGET	MIN - "OK" RANGE - MAX	
pH	7.4	7.2	7.8
ALKALINITY	80 ppm	40 ppm	120 ppm
HARDNESS	100 ppm	75 ppm	150 ppm
HARDNESS (SALT SYSTEM)	50 ppm	25 ppm	75 ppm
CHLORINE	3 ppm	1 ppm	5 ppm

Maintaining the water quality and the cleanliness of the filters in your spa is your responsibility. Keeping the spa water balanced prolongs the life of the spa components and will make the water more comfortable. Your dealer can guide you through the process of achieving and maintaining perfect water in your spa, given your local conditions. Your program will depend on your water's mineral content, how often you use your spa, and how many people use it. Watkins Wellness has developed several water care systems and products to simplify water care which are available from authorized **CALDERA** dealers.

FRESHWATER Salt System	Vanishing Act™ Calcium Remover
FRESHWATER Salt Test Strips	FRESHWATER 5-way Test Strips
FRESHWATER Smart Monitoring System	CLEAN SCREEN Prefilter
FRESHWATER Dosing System	

CHEMICAL SAFETY

When using chemicals, read the labels carefully and follow directions precisely. Though chemicals protect you and your spa when used correctly, they can be hazardous in concentrated form. Always observe the following guidelines:

- Allow only a responsible person to handle spa chemicals. Keep them out of the reach of children.
- Accurately measure the exact quantities specified, never more. Do not overdose your spa.
- Handle all containers with care. Store in a cool, dry, well ventilated place.
- Always keep chemical containers closed when not in use. Replace caps on their proper containers.
- Don't inhale fumes, or allow chemicals to come in contact with your eyes, nose, or mouth. Wash your hands immediately after use.
- Follow the emergency advice on the product label in case of accidental contact, or if the chemical is swallowed. Call a doctor or the local Poison Control Center. If a doctor is needed, take the product container along with you so that the substance can be identified.
- Don't let chemicals get on surrounding surfaces or landscaping. Don't use a vacuum cleaner to clean up chemical spills.
- Never smoke around chemicals. Some fumes can be highly flammable.
- Don't store any chemicals in the spa equipment compartment.

HOW TO ADD CHEMICALS TO THE WATER

IMPORTANT: All spa water chemicals must always be added directly into or in front of the filter compartment while a jet pump is running, and it must run for a minimum of ten minutes.

TO ADMINISTER SPA WATER CHEMICALS:

1. Fold back the cover and remove the filter compartment cover.
2. To activate the Clean Cycle, press the soft button next to **Clean** on the Home Screen.
3. Carefully measure the recommended amount of chemical and slowly pour it over the filter basket area. Use care not to splash chemicals on your hands, in your eyes, on the spa sheet surface, or on the siding.
4. Replace the filter compartment cover and close the spa cover.
Risk of Drowning: Never leave an open spa unattended!

⚠ **WARNING:** High sanitizer levels can cause discomfort to the user's eyes, lungs and skin. Always allow the sanitizer level to fall to the recommended range before using the spa.

IMPORTANT "SUPER CHLORINATION/NON-CHLORINE SHOCK TREATMENT" NOTE: After administering a super chlorination treatment or non-chlorine shock to your spa, leave the cover open for a minimum of 20 minutes to allow the oxidizer gas to vent. A high concentration of trapped oxidizer gas which may exist as a result of the shock treatment (not daily sanitation) may eventually cause discoloration or degradation to the bottom of the cover. This type of damage is considered chemical abuse and is not covered under the terms of the limited warranty.

FUNDAMENTALS OF WATER MAINTENANCE

- **Testing:** Test the water weekly or each time the spa is used with convenient 5-way test strips or more accurate liquid/tablet reagent test kit per instructions. Critical parameters: sanitizer level, pH, Calcium Hardness (CH), and Total Alkalinity (TA). Store test equipment in a dark, cool, dry place to maintain potency.
- **Water Filtration:** The filtration used in **CALDERA** spas helps keep water clean by circulating sanitizer and removing waste from the spa. Regularly inspect and clean filters for peak performance.
- **Chemical Balance/pH Control:** It is important to adjust the primary water parameters (Total Alkalinity, Calcium Hardness, pH) into the recommended ranges so that they are stabilized or balanced. Balance the water chemistry every time you fill the spa with new water and then during the life of that body of water. Keeping the water in balance prevents damage by holding the pH in a safe range and preventing calcium scale formation on spa equipment. A low pH can damage metal components whereas a high pH can cause high levels of calcium to form scale. Your dealer should provide a detailed water chemistry orientation soon after your new spa is filled for the very first time.

ALKALINE SPA WATER (SCALING ZONE)	8.2	ADD pH DECREASER TO LOWER pH
	7.8	
COMFORT ZONE	7.6	IDEAL
	7.4	
	7.2	
ACIDIC SPA WATER (CORROSIVE ZONE)	6.8	ADD pH INCREASER TO RAISE pH
	pH	

- The following three water components must be kept in balance to avoid damage to the spa. Do balance these components in the order they are listed here as each will help you balance the next using a minimum amount of chemicals.
1. **Calcium Hardness (CH)** – CH is the measure of the amount of dissolved calcium in the water. Low levels can make the water corrosive and high levels cause scale formation of spa components. The recommended CH reading is between **75 - 150 ppm**. A hardness between **25 - 75 ppm** is recommended with a **Salt System**. If the CH level is too high, lower it with the **VANISHING ACT** calcium remover (pg. 11) per instructions. Once in balance, the CH reading normally remains stable until new water is added. Great care must be taken when filling the spa from a water softener to ensure that the calcium remains in balance and avoid damage to the spa.
 2. **Total Alkalinity (TA)** - TA is a measure of the water's ability to resist changes of pH or buffer capacity. A low TA allows the pH to fluctuate easily. The recommended TA reading is between **40 - 120 ppm**. To raise the TA, use pH/Alkalinity Up (sodium hydrogen carbonate). To lower the TA, use pH/Alkalinity Down (sodium bisulfate). Once the TA is balanced, it normally remains stable until the next drain/refill. We recommend you check the TA reading once per month. Raising/lowering the TA may cause the pH readings to fluctuate widely. Ignore the pH readings on the test strip while you are balancing the TA.
 3. **pH** - The pH is the measure of the acidity and alkalinity. Maintaining the proper pH level will optimize the effectiveness of the sanitizer, preventing damage to the spa and physical discomfort for spa users. A low pH dissipates sanitizer, causes corrosion, and irritates spa users. A high pH level will neutralize sanitizer, promote

scaling and cloud water. The recommended pH reading is between **7.2 - 7.8**. To lower the pH level, use **FRESHWATER** pH/Alkalinity Down (sodium bisulfate). To raise the pH level, use pH/Alkalinity Up (sodium carbonate).

- **Water Conditioners:** Spa fill water varies from location to location and user to user, therefore it is important to consult with your dealer for an appropriate program.
 - a. **VANISHING ACT** – High levels of calcium and some minerals can be removed from the water with the single use **VANISHING ACT**. High calcium levels can cause scale formation on the spa equipment and shell.
 - b. **CLEAN SCREEN** pre-filter –The **CLEAN SCREEN** pre-filter should be used at every fill and top-off to remove contaminants from the fill water, especially iron, copper, and manganese. Many water sources including well water contain high concentrations of minerals that can cause staining of the shell and plastics.
 - c. **Stain and Scale control** – For water high in calcium and minerals, it may be necessary to use an anti-scalant like Stain and Scale control. As water evaporates from your spa and new water is added, the amount of dissolved minerals like calcium, copper, iron, and manganese will increase. (Minimize evaporation by keeping the cover on the spa whenever possible.) High iron or copper content in the water may produce green or brown stains on the spa.
 - d. **Foam Inhibitors** - Soap is introduced into the spa water from users' bodies and swimming apparel and can cause the spa water to foam when the jets are used. Low levels of calcium hardness (soft water) can increase foaming. Although ozone can oxidize soap residual, it may become necessary to add Foam Inhibitors to suppress the foam. Excessive soap in the water may require a water change to resolve.
- **Oxidizers:** Ozone and Monopersulfate (MPS) are oxidizers used to prevent the buildup of contaminants, maximize sanitizer efficiency, minimize combined chlorine, and improve water clarity. They are to be used in conjunction with EPA registered sanitizers. The **FRESHWATER** III high output ozone system uses Corona Discharge technology to produce a high concentration of ozone which is injected into the spa water 24 hours per day. Chlorine-Free Oxidizer, Monopersulfate (MPS) is a granular oxidizing chemical.
- **Sanitizers:** Maintaining the recommended residual level of an EPA registered sanitizer at all times will decrease the occurrence of unsafe bacteria and viruses in your spa water. The recommended Free Available Chlorine (FAC), the amount of available chlorine sanitizer, is **3 - 5 ppm**. A low FAC can allow bacteria and viruses to grow rapidly in the warm water, and a high FAC can cause discomfort to the user's eyes, lungs, and skin. Each sanitizer carries its own instructions regarding how much to use and when to add it to the spa water. Consult your dealer for their recommendations and instructions on proper sanitizing of the spa.

WATKINS WELLNESS recommends the following sanitizers:

- **FRESHWATER** Salt System
- Concentrated Chlorinating Granules
- Liquid sodium hypochlorite (do not use splashless)

WATKINS WELLNESS also approves the following sanitizers:

- Biguanide

WARNING: DO NOT use tri-chlor chlorine, bromo-chloro-dimethyl-hydantoin (BCDMH), or any type of compressed bromine or chlorine, acid or any type of sanitizer which is not recommended by **WATKINS WELLNESS**.

THE CALDERA SPA WATER MAINTENANCE PROGRAM

FILLING THE SPA WITH WATER

Use the **FRESHWATER CLEAN SCREEN** pre-filter to remove unwanted contaminants such as rust, dirt, detergents, and algae from the fill water. Dissolved metals, copper, iron, and manganese are also removed. Instructions are included with the **CLEAN SCREEN** pre-filter. Always fill the spa through the filter compartment. Do not fill your spa using water from a swimming pool as pool chemicals are very different from those used in a spa and can damage your spa.

ADDING CHEMICALS TO THE WATER

All spa water chemicals, including granulated dichlor, MPS, granulated pH increaser or decreaser, granulated total alkalinity increaser, liquid stain and scale inhibitor, and liquid defoamer must always be added directly into the filter compartment while the jet pump is running in its high speed mode, and it must run for a minimum of ten minutes with the cover off. Use the Clean button/feature to ensure that the chemicals are properly mixed when adding.

BUILDING A SANITIZER ROUTINE

During the first month of ownership, measure the sanitizer residual daily in order to establish a baseline of sanitizer needed vs. spa usage. Sanitizer needed is the amount of Free Available Chlorine needed to accommodate the number of users and their combined usage time. For example, two spa users for twenty minutes every day creates regular demand on the sanitizer that is used to determine how much sanitizer to add in order to maintain the proper residual. If the usage pattern increases dramatically with invited guests, the amount and frequency of sanitizer required increases dramatically.

MANUAL CHLORINE (SODIUM DICHLOR)

Watkins Wellness recommends the use of **FRESHWATER** Concentrated Chlorinating Granules (sodium dichlor) for sanitizing the water. Sodium dichlor is preferred because it is totally soluble, dissolves quickly, and is nearly pH neutral. The recommended Free Available Chlorine (FAC), the amount of available chlorine to sanitize the spa, 3 -5 ppm.

If the FAC is too low: Increase the FAC by adding granulated sodium dichlor.

If the FAC is too high: Allow time to pass and the FAC level will naturally drop over time.

If the spa smells of chlorine: super chlorinate or shock the spa FAC chlorine does not have an odor whereas combined spent chlorine (chloramines) has a strong chlorine odor that can be eliminated by shocking the water.

IMPORTANT: There are several forms of stabilized chlorine available for use in spas and swimming pools. It is extremely important to choose one specifically designed for spas. Use of an incorrect product such as tri-chlor which has a very low pH (2.6) and dissolves too quickly in hot water, results in extremely high levels of chlorine that **WILL** cause damage to your spa. Use of a liquid or compressed bromine/chlorine or unapproved sanitizer **WILL** damage your spa and is specifically not covered under the terms of the limited warranty.

PERFORMING SUPER CHLORINATION/ NON-CHLORINE SHOCK TREATMENT

A weekly or monthly super chlorination (1.5 tsp dichlor/950 liters (250 gallons)) or shock (4tbs mps/950 liters (250 gallons)) may be required of your chosen sanitation program. Increasing chlorine to 5 ppm for 24 - 48 hours removes excess waste and chloramines from the water. Sodium dichlor is 6x stronger than MPS and may be a more appropriate for those users that experience heavy bather load conditions. Operate all jets and leave the cover open for a minimum of 20 minutes to allow the oxidizer gas to vent to prevent damage and discoloration to the cover and pillows after administering a super chlorination or shock to your spa. This type of damage is considered chemical abuse and is not covered under the terms of the limited warranty.

IMPORTANT: Always allow the Free Available Chlorine to fall below 5 ppm before using your spa.

⚠ DANGER: Never leave an open spa unattended, especially if there are children present!

FRESHWATER IQ (OPTIONAL)

This system blends three game-changing innovations into one integrated solution:

1. FRESHWATER Salt System

Converts salt into chlorine using a disposable titanium cartridge to keep your spa water fresh, clear, and natural feeling.

2. Smart Monitoring System

Automatically checks your water every hour and gives you clear guidance through your spa's touchscreen control panel.

3. FRESHWATER Precision Dosing System

Dispenses the exact amount of pH Up, pH Down, and Phosphate Remover when you need it with no measuring or mess using refillable cartridges incorporated neatly under the filter lid.

ADDITIONAL FRESHWATER WATER CARE PRODUCTS

- **FRESHWATER CLEAN SCREEN** Pre-filter
- **FRESHWATER** Concentrated Chlorinating Granules
- **FRESHWATER** Monopersulfate (MPS), Chlorine-Free Oxidizer (not compatible with **FRESHWATER** Smart Monitoring System)
- High output ozone system (not compatible with **FRESHWATER** Smart Monitoring System)
- **VANISHING ACT** calcium remover

It is important to follow the recommended application and maintenance programs outlined for each product's use. If the spa is being used over an extended period of time, such as a whole afternoon or evening, additional sanitizer will be needed.

VANISHING ACT INSTRUCTIONS



MAKENA



SALINA



MARTINIQUE



SEYCHELLES



REUNION



KAUAI

Instructions for Use:

1. After filling your hot tub, use a test strip to measure the hardness level of the water. If hardness is above **100 ppm**, use the **VANISHING ACT** calcium remover to soften the water. **Suggested Hardness Level: between 75 - 150 ppm, (it must be between 25 - 75 ppm when using the FRESHWATER Salt System in order to work).**
2. Rinse the **VANISHING ACT** calcium remover with running water until water runs clear. When placed in the hot tub, slight color transfer to the water may occur and can be easily resolved with chlorine.
3. Locate your spa above to determine which jet suction fitting the **VANISHING ACT** calcium remover will be placed up over. Use the circle to determine location.
 - a. Press **OPTIONS** hard button on the Control panel.
 - Press the soft button next to **Set-Up**.
 - Press the soft button next to **More**
 - Press the soft button next to **Soft Water** to start low speed jet pump for 6 hours.
 - Place the **VANISHING ACT** calcium remover firmly against the associated jet suction fitting.
 - b. Test the spa water for hardness after jets shut off, which will take around 6 hours.

IMPORTANT:

- Always make sure water is balanced and properly sanitized, using the EPA approved sanitizer, before entering your hot tub.
- For maximum effectiveness, ensure that the calcium remover remains on the suction fitting while the calcium remover is in use.
- Calcium remover may not be necessary if water hardness is already in or below the suggested range.
- Multiple calcium removers may be needed if initial water hardness is above 200 ppm.

OZONE MAINTENANCE (OPTIONAL)

If reduced or no ozone bubbles are coming from the heater return (clogged ozone injector) or no ozone, clean the injector:

⚠ DANGER: Nitric acid accumulates in the air lines of the ozonator and injector, and will cause severe chemical burns if direct skin contact is made. Always wear protective gloves, glasses and clothing when working on the ozonator or injector lines. To prevent inhalation or ingestion of the nitric acid, DO NOT blow or inhale with your mouth to any of the adapters, fittings or tubing of the ozonator or injector air lines.

1. Place 0.5 liter of white vinegar into a cup or bucket.
2. Carefully loosen the long tubing attached to the bottom of the ozonator, located in the equipment compartment.
3. Place the end of the tubing into the vinegar, making certain that the end of the tubing sits at the bottom of the container.
4. Run the spa until all 0.5 liter of the vinegar are gone. This should allow an ample flow of vinegar to be run through the injector and clear the blockage.
5. Reinstall the tubing to the bottom of the ozonator.

Water chemistry damage is not covered by the warranty. The chemical levels and water quality in the spa are under your direct control. With proper basic care, the spa will provide many years of hot water relaxation. If you are unsure about any chemical or its usage in the spa, contact your Authorized Dealer, or Watkins Wellness. Ozone can NOT be used with the **FRESHWATER** IQ Smart Monitoring System.

DO:

- Add all chemicals slowly into the filter compartment with the jet pump operating for ten minutes.
- Use special care if using baking soda to clean either the interior or exterior plastic surfaces.

IMPORTANT: Watkins Wellness DOES NOT recommend the use of any floating chemical dispenser. Damage to the spa shell or components caused by a floating chemical dispenser is specifically not covered under the terms of the limited warranty. Floating dispensers can become trapped in one area and cause an over-sanitization or release large chunks of sanitizer that very quickly chemically burn the shell and cover.

DON'T:

- Use compressed sanitizers.
- Use a floater type sanitization system as a low or no maintenance solution to your spa maintenance program.
- Use a sanitizer which is not designed for spas.
- Use swimming pool (muriatic) acid to lower pH.
- Broadcast or sprinkle the chemicals onto the water surface. This method may cause chemically-induced spa surface blistering (chemical abuse).

VACATION WATER CARE INSTRUCTIONS

If you plan to be away from home, follow these instructions to ensure that the water quality of your spa is maintained:

SHORT TIME PERIODS (3-5 DAYS)

1. Adjust the pH by following the instructions outlined in the Water Quality and Maintenance section.
2. Sanitize the water by following the shock procedures also listed in the Water Quality and Maintenance section.
3. Lock your cover in place using the coverlocks.
4. Upon your return, sanitize the water by following the shock procedures, and balance the pH.

LONG TIME PERIODS (5-14 DAYS)

Prior to leaving:

1. At least one day before you leave, set the temperature to its lowest level. This setting should represent an approximate water temperature 27°C (80°F).
IMPORTANT: Spa water oxidizers such as sodium dichlor (chlorine) maintain their level of effectiveness substantially longer in warm water 27°C (80°F) than in hot water 38°C - 40°C (101°F to 104°F).
2. Adjust the pH as required. Sanitize the water by following the shock procedures.

Upon your return:

3. Sanitize the water by following the shock procedures. Return the set temperature to its original setting. The spa water will be safe for you to use once the Free Available Chlorine residual level has dropped below 5.0 ppm.
IMPORTANT: If you will not be using your spa for an extended period of time (in excess of 14 days) and an outside maintenance service (or neighbor) is not available to assist with the water maintenance, draining or winterizing of the spa is recommended.

SUPPLEMENTAL WATER MAINTENANCE

Proper water sanitation and mineral balance (pH control) are absolutely essential for a complete spa water maintenance program. Here are two other popular water additives that are optional:

Mineral Deposit Inhibitors

As water evaporates from your spa and new water is added, the amount of dissolved minerals will increase. (Minimize evaporation by keeping the cover on the spa whenever possible.) The spa water may eventually become "hard" (Calcium Hardness too high) enough to damage the heater by calcifying its surface. Proper pH control can minimize this.

Normal soap build-up will require water replacement regularly enough that mineral deposits normally are not a problem.

Occasionally, high iron or copper content in the water may produce green or brown stains on the spa. A stain and scale inhibitor may help to reduce these metals.

IMPORTANT: Well water may contain high concentrations of minerals. The use of a low water volume, extra-fine pore water filter (in-line pre-filter such as the **CLEAN SCREEN** pre-filter) will help to remove many of the larger particles during the filling of the spa. In-line pre-filters can be purchased at your local **CALDERA** dealer.

Foam Inhibitors

Spa water requires changing due to the buildup of soap in the water. Typically, soap will cause the spa water to foam when the jets are used. Soap is introduced into the spa water from two sources: users' bodies, which retain a soap residual after showering, and swimming apparel, which retains soap after washing.

Foam inhibitors can suppress foam, but cannot remove soap from the water. Soap is very difficult to remove from the water because soap is not oxidized by any chemical added to the spa. Only ozone can oxidize soap. Eventually the soap build-up in the water will be concentrated, resulting in an unclean feeling on the bather's skin, which is impossible to remedy. When this occurs, it's time to drain and refill the spa. Depending on the soap input, the water should last about four months before needing to be drained.

GLOSSARY

The following chemical terms are used in this Water Quality and Maintenance section. Understanding their meaning will help you to better understand the water maintenance process.

Bromamines: Compounds formed when bromine combines with nitrogen from body oils, urine, perspiration, etc. Unlike chloramines, bromamines have no pungent odor, and are effective sanitizers.

Bromine: A halogen sanitizer (in the same chemical family as chlorine). Bromine is commonly used in stick, tablet, or granular form however, stick and tablet form should NOT be used. NOT be used with the Smart Monitoring System

Calcium Hardness: The amount of dissolved calcium in the spa water. This should be between 75 - 150 ppm and when using a Salt System between 25 - 75 ppm. High levels of calcium can cause cloudy water and scaling. Low levels can cause harm to the spa equipment.

Chloramines: Compounds formed when chlorine combines with nitrogen from body oils, urine, perspiration, etc. Chloramines can cause eye irritation as well as having a strong odor. Unlike bromamines, chloramines are weaker, slower sanitizers.

Chlorine: An efficient sanitizing chemical for spas. Watkins Wellness recommends the use of sodium dichlor-type granulated chlorine. This type is preferred because it is totally soluble and nearly pH neutral.

Chlorine (or Bromine) Residual: The amount of chlorine or bromine remaining after chlorine or bromine demand has been satisfied. The residual is, therefore, the amount of sanitizer which is chemically available to kill bacteria, viruses and algae.

Corrosion: The gradual wearing away of metal and plastic spa parts, usually caused by chemical action. Generally, corrosion is caused by low pH or by water with levels of TA, CH, pH or sanitizer which are outside the recommended ranges.

Halogen: Any one of these five elements: fluorine, chlorine, bromine, iodine, and astatine.

MPS: Monopersulfate is a non-chlorine oxidizer.

Nitric Acid: The formulation of nitric acid, a highly corrosive chemical, is a byproduct of the ozone generating process. Nitric acid is produced in very small quantities and is readily dissolved in the water stream with ozone.

Oxidizer: The use of an oxidizing chemical is to prevent the buildup of contaminants, maximize sanitizer efficiency, minimize combined chlorine and improve water clarity. See MPS and Ozone.

Ozone: Ozone is a powerful oxidizing agent which is produced in nature and artificially by man. Ozone forms no byproducts, oxidizes chloramines, and will not alter the water's pH. Ozone can NOT be used with the Smart Monitoring System.

pH: The measure of the spa water's acidity and alkalinity. The recommended pH for the spa water is 7.2 to 7.8. Below 7.0 (considered neutral), the spa water is too acidic and can damage the heating system. Above 7.8, the water is too alkaline and can result in cloudy water, and scale formation on the shell and heater.

ppm: The abbreviation of "parts per million", the standard measurement of chemical concentration in water. Identical to mg/l (milligrams per liter).

Reagent: A chemical material in liquid, powder, or tablet form for use in chemical testing.

Sanitizer: Sanitizers are added and maintained at recommended residuals to protect bathers against pathogenic organisms which can cause disease and infection in spa water.

Scale: Rough calcium-bearing deposits that can coat spa surfaces, heaters, plumbing lines, and clog filters. Generally, scaling is caused by mineral content combined with high pH. Additionally, scale forms more readily at higher water temperatures.

Super-Chlorination: Also known as "shock treatment." Super-Chlorination is a process of adding significant doses of a quick dissolving sanitizer ("dichlor" is recommended) to oxidize non-filterable organic waste and to remove chloramines and bromamines.

Total Alkalinity (TA): The amount of bicarbonates, carbonates, and hydroxides present in spa water. Proper total alkalinity is important for pH control. If the TA is too high, the pH is difficult to adjust. If the TA is too low, the pH will be difficult to hold at the proper level. The desired range of TA in spa water is 40 to 120 ppm.

OPERATING INSTRUCTIONS

MAIN CONTROL PANEL

The main control panel provides a quick visual check of the spa's status and allows the user to set the temperature, activate the jets & lights, lock the temperature and/or spa functions. Other optional functions may also be available depending on the spa model and accessory equipment that has been installed into the spa. The main control panel has eight buttons.



HARD BUTTONS

The four labeled outer buttons are referred to as "Hard buttons". These buttons are fixed and their functions do not change.

JETS - If jet pump indicator light is off and JETS hard button is pressed, the 1st jet pump function will activate and the main control panel display will advance to the Jets menu.

If jet pump indicator light is on and the JETS hard button is pressed while in any screen other than the Jets menu, the jets pump function does not change, only the main panel screen will change to the Jets menu.

LIGHTS - If lights are off, press LIGHTS hard button from any screen to turn on all lights and display the Lighting Options menu. Continue to press the LIGHTS hard button to cycle through lights zones.

OPTIONS - Transitions to the Options screen to access temperature and setup menu

BACK - Goes back one menu.

SOFT BUTTONS

The four inside buttons are referred to as "soft buttons". Pressing a soft button will activate the function on the control panel screen closest to that button. After a period of non-use (45 seconds) the display will go back to the Home screen and will remain on for several minutes before going to sleep mode. Pressing any button will wake up a sleeping display.

INDICATOR ICONS

At a glance, the indicator icons are visible on the main control panel. The indicator icons work independently from the rest of the control panel display. They are displayed so that you may know the status of your spa at a glance. NOTE: Indicators will not be visible when Main Control Panel goes into sleep mode.

READY Indicator: The READY indicator will display when the spa water temperature is within 1°C (2°F) of the set temperature, and will turn off when the temperature is outside of that range. If you increase or decrease the temperature setting of the spa, the ready indicator will turn off until the water temperature reaches the acceptable range for the new temperature setting. A flashing READY indicator means a problem may exist with the temperature sensor (see Troubleshooting section for more information)

Spa Light Indicator: The Spa Light indicator is displayed when any light inside the spa is on. The indicator icon will remain solid as long as any manual light is activated.

Spa or Temperature Lock Indicator: The Spa or Temperature Lock indicator is displayed when either the Spa Lock, Temperature Lock or both are activated. Lock indicator does not flash.

Jet Pump Indicator: The Jet Pump indicator is displayed whenever a jet pump is on. The Jet Pump indicator will flash whenever the spa is in the ten-minute Clean Cycle or Auto Clean Cycle.

Water Care Indicator: The Water Care indicator icon is displayed whenever a water care device is detected in the system and the water care system is operating correctly. The icon will flash if the water care system requires attention.

POWER Indicator: The POWER indicator is 'on' when the spa is properly supplied with power. It also provides a diagnostic function—a flashing power indicator indicates that the heater high limit has tripped, meaning that either the spa water is above its acceptable temperature range, or a malfunction has occurred within the spa (such as low circulation due to clogged filters). When the power indicator is not displayed it means that there is a problem with the spa control box or the power supplied to the spa (see Troubleshooting section for more information).

OPTION SCREEN

The Option screen is an intermediate screen that gets you to various optional settings.

Press the OPTIONS hard button on the control panel to display the Options screen.

Press the soft button next to the descriptions to access the description's screen.

IMPORTANT: Audio, Smart Monitoring System or Salt System will only be displayed on your Options screen if your spa is equipped with these features.

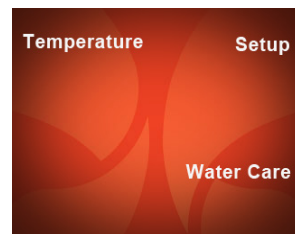

With Smart Monitoring System

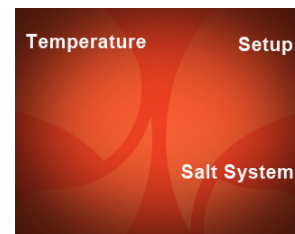

With Freshwater Salt System ONLY

HOME SCREEN



The temperature displayed in the center of the Home screen is the actual temperature of the spa water. If the READY icon is displayed and solid on the control panel, then the actual spa temperature is within 1°C (2°F) of the set temperature. The corner soft button functions are as follows:

MEMORY

This feature will recall the last active setting for jets and lights prior to pressing the All Off button.

ALL OFF

This feature will shut jets, lights and audio (if installed) off immediately, while saving the last active jets and lights settings.

AUDIO (OPTIONAL)

If you purchased music with your spa, this feature will take you to the Audio menu.

IMPORTANT: Some soft key functions will only be visible if available accessory has been installed.

CLEAN

Provided as a convenient timer for water maintenance, this function activates the jet pump on high for a ten minute period. The jet icon will flash to indicate the jet pump is engaged and in the Clean cycle. During this cycle add properly measured spa water chemicals into the filter compartment. The jet pump and clean icon will automatically shut off after ten minutes.

TEMPERATURE CONTROL

The set temperature range is from 26°C to 40°C (80°F to 104°F). The water temperature of any spa may rise or lower slightly depending on the current use and condition of your spa and on outside temperatures.

The set temperature of the spa water will automatically be 38°C (100°F) the first time power is applied. This is the setting programmed at the



factory. After the spa has been set up and used, the last temperature value set by the user will be stored in memory. If power is disconnected from the spa, it will automatically revert to the last set temperature when power is reapplied.

- Press the OPTIONS hard button on the Control panel.
- Press the soft button next to **Temperature**. The set temperature screen will be displayed. This screen will automatically revert to the Home screen after 45 seconds of non-use.

To increase the set temperature of the spa water:

Press the OPTIONS hard button on the Main Control panel.

Press the soft button next to **Temperature**.

Press the soft button next to ▲. Each time the button is pressed, the set temperature display will increase by .5°C (1°F). If the button is held down, the set temperature display will increase by .5°C (1°F) every half-second.



To decrease the set temperature of the spa water:

Press the OPTIONS hard button on the Main Control panel.

Press the soft button next to **Temperature**.

Press the soft button next to ▼. Each time the button is pressed, the set temperature display will decrease by .5°C (1°F). If the button is held down,

the set temperature display will decrease by .5°C (1°F) every half-second.



If the set temperature value does not change, check to see whether the TEMP LOCK or SPA LOCK features are on. When either of these features is activated, the temperature control is disabled.

The temperature can be displayed in Fahrenheit or Celsius. Press the soft button next to the °F/°C to choose one or the other.

LOCKING FEATURES

The two locking features, Temperature Lock and Spa Lock, are activated at the main control panel. Once activated, a lock will remain active until the specific button combination is pressed to disable the lock. Even if power to the spa is disconnected even briefly, the lock will remain activated.

TEMPERATURE LOCK



When activated, the Temperature Lock feature prevents a change in your desired water temperature setting. All other functions on the main and auxiliary control panels will operate normally while the temperature lock is "ON". This feature prevents others from changing the desired settings.

To activate the Temperature Lock:

- Press the OPTIONS hard button on the Main Control panel.
- Press the soft button next to **Temperature**.
- Press the soft button next to **Temp Lock Off** to change the screen to **Temp Lock On**.

IMPORTANT: The Temperature/Spa lock icon will be displayed during a temperature lock condition.

To deactivate the Temperature Lock:

- Press the OPTIONS hard button at the Main Control panel.
- Press the soft button next to **Temp Lock**.
- Press the soft button next to **Temp Lock On** to change the screen to **Temp Lock Off** and turn the Temperature lock and icon off.

SET-UP

In the Setup screen you will be able to set the spa clock, see internal information about your spa, change to °F or °C, change brightness of the screen, change the language and lock out the spa screen functions.

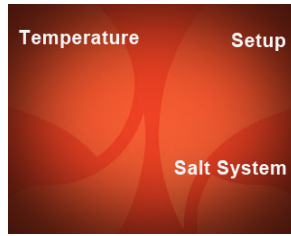

Press the OPTIONS hard button on the control panel to display the Options screen.

Press the soft button next to **Setup** to access the Setup screen.

SPA LOCK



When activated, the Spa Lock feature disables all functions on the control panel. It prevents others from tampering with the jets, lights and temperature settings on your spa. The control panel will not respond to any hard or soft buttons when pushed in Spa Lock mode.

To activate the Spa Lock:

- Press the OPTIONS hard button.
- Press the soft button next to **Setup**.
- Press the soft button next to **Spa Lock Off**.

IMPORTANT: The Temperature/Spa Lock icon will be displayed while the screens are locked.

To deactivate the Spa Lock:

- Press and hold the OPTIONS hard button and the LIGHTS hard button at the same time for 3 seconds. The spa lock icon will turn off.

IMPORTANT: You can activate the spa lock feature even when the temperature lock is already on. You do not need to turn off the temperature lock in order to turn on the spa lock feature. If the temperature lock was already on when you activate the spa lock, it will remain on when you turn off the spa lock.

BRIGHTNESS

If you would like to change the screen brightness of the Main Control panel:

Press the OPTIONS Hard button on the Main Control panel.

Press the soft button next to **Setup**.

Press the soft button next to **Brightness** to lower the brightness from 7 down to 1.



IMPORTANT: Pressing the Brightness soft button at number 1 will increase the screen brightness back to 7.

ENERGY SAVINGS MODE

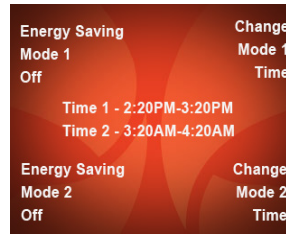

This mode allows you to save energy by shutting off the heater at two predetermine times of the day for up to 6 hours on each setting.

To enter into the Energy Savings Mode:

- Press the OPTIONS hard button.
- Press the soft button next to **Setup**.
- Press the soft button next to **Energy Saving Mode**

In this screen you can turn Mode 1 or Mode 2 ON or OFF by pressing the soft button next to that description. **NOTE:** When the mode is turned ON you can not change the mode time.

- Press the soft button next to **Change Mode 1 Time** to set the Hour start time for Energy Savings Mode 1.
- Press the soft button next to ▲ to increase the hour or Press the soft button next to ▼ to decrease the hour.
- Press the soft button next to **Time Format** (if your clock is set to 12 hour mode) to select AM or PM.



Press the soft button next to **Mins** to take you to the Minutes screen.

NOTE: You will need to go to the next screen to be able to save the time.

- Press the soft button next to ▲ to increase the Minutes or press the soft button next to ▼ to decrease the Minutes.
- Press the soft button next to **Hrs** to take you back to the Hour screen.

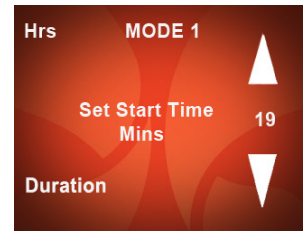

Press the soft button next to **Duration** to set how many hours you would like to the Energy Savings Mode to run.

- Press the soft button next to ▲ to increase the Duration up to 6 hours maximum or press the soft button next to ▼ to decrease the Duration.
- Press the soft button next to **Change the Start Time** to take you back to the Set Start Time Mins screen.
- Press the soft button next to **Confirm Energy Saving** to save the time and duration while bringing you back to the Main Energy Saving screen where you could set the MODE 2 times. **NOTE:** MODE 1 and MODE 2 can NOT overlap in time when turned ON.

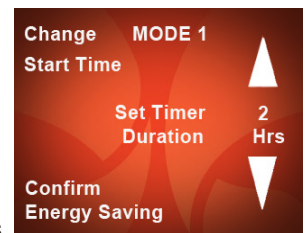

AUTO CLEAN CYCLE

The Auto Clean Cycle will activate the jets for 10 minutes total time every day at the same scheduled time.

- Press the **OPTIONS** hard button on the Control panel.
- Press the soft button next to **Setup**
- Press the soft button next to **More**
- Press the soft button next to **Auto Clean Cycle**

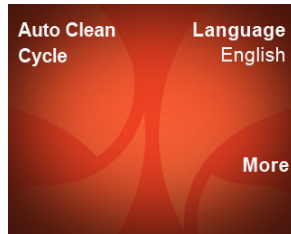

Press the soft button next to **Auto Clean Cycle** to turn Clean Cycle either On or Off. The Clean cycle will activate at the Start Time indicated on the screen.

NOTE: When Auto Clean Cycle is On you can NOT change the time.

To Change Time press the **Change Time** soft button.

- Press the soft button next to ▲ to increase the hour or press the soft button next to ▼ to decrease the hour.
- Press the soft button next to **Time Format** (if your clock is set to 12 hour mode) to select AM or PM.

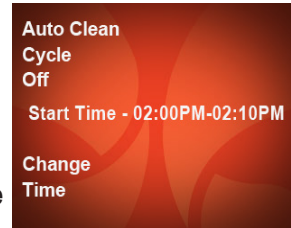

Press the soft button next to **Mins** to take you to the Minutes screen. **NOTE:** You will need to go to the next screen to be able to save the time.

- Press the soft button next to ▲ to increase the Minutes or press the soft button next to ▼ to decrease the Minutes.
- Press the soft button next to **Hrs** to take you back to the Hour screen.
- Press the soft button next to **Confirm Set Time** to enter the Start time.

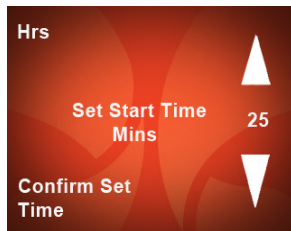

LANGUAGE

The Control panel screen can be viewed in seven different languages. The languages are English, French, German, Dutch, Swedish, Norwegian, and Spanish. To change languages:

- Press the **OPTIONS** hard button on the Control panel.
- Press the soft button next to **Setup**.
- Press the soft button next to **More**
- Press the soft button next to **Language** until the desired language is visible.



IMPORTANT: Should you accidentally change the language screen into a language you don't know, simply repeat the previous steps where Set-up is in the top right corner and Language is in the lower right corner.

VANISHING ACT CYCLE

The **VANISHING ACT** Cycle will activate the jets for 6 hours, ONLY to be used with **VANISHING ACT** (see page 11)

- Press the **OPTIONS** hard button on the Control panel.
- Press the soft button next to **Setup**
- Press the soft button next to **More**
- Press the soft button next to **More**
- Press the soft button next to **VANISHING ACT** to turn from Off to On or On to Off.

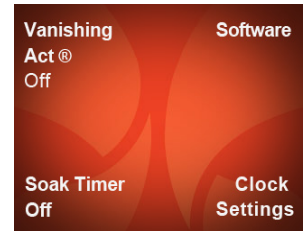

SOAK TIMER

Soak Timer is a count down to let you know you have been in the tub for 15 minutes. If jets are on at the end of the timer then they will be turned off letting you know your time is up. If there are no jets on then jet pump 1 will turn on high speed for 5 seconds then turn off.

- Press the **OPTIONS** hard button on the Control panel.
- Press the soft button next to **Setup**
- Press the soft button next to **More**
- Press the soft button next to **More**
- Press the soft button next to **Soak Timer** to turn Soak Timer ON for 15 minutes.

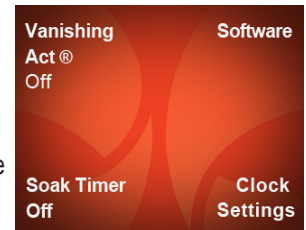

To set Soak Timer for a 30, 45 or 60 minute soak time, press and hold soft button next to **Soak Timer** when timer is Off for several seconds to bring up screen.

- Press the soft button next to ▲ to increase the duration or press the soft button next to ▼ to decrease the duration.
- Press the soft button next to **Confirm** to activate the Soak Timer for set duration.

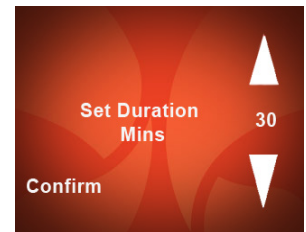

SOFTWARE

This screen will tell you specific software information about your spa.

- Press the **OPTIONS** hard button on the Control panel.
- Press the soft button next to **Setup**
- Press the soft button next to **More**
- Press the soft button next to **More**
- Press the soft button next to **Software** to show the software screen.



CLOCK SETTINGS

This screen will allow you to set the current time.

- Press the **OPTIONS** hard button on the Control panel.
- Press the soft button next to **Setup**
- Press the soft button next to **More**
- Press the soft button next to **More**
- Press the soft button next to **Clock Settings** to show the screen.

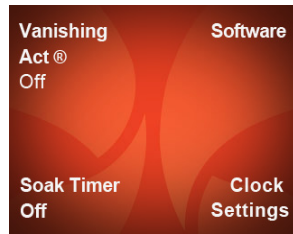

Press the soft button next to ▲ to increase the hour or press the soft button next to ▼ to decrease the hour.

- Press the soft button next to **Time Format** to change to either 12Hrs (AM/PM) or 24Hrs.

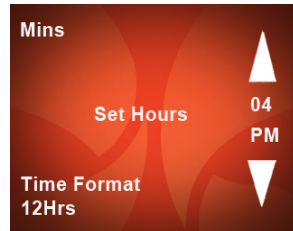

Press the soft button next to **Mins** to take you to the Minutes screen. **NOTE:** You will need to go to the next screen to be able to save the time.

- Press the soft button next to ▲ to increase the Minutes or Press the soft button next to ▼ to decrease the Minutes.
- Press the soft button next to **Hrs** to take you back to the Hour screen.
- Press the soft button next to **Confirm Set Time** to enter the Clock time.

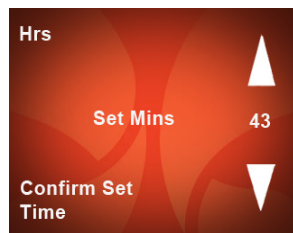

FRESHWATER SALT SYSTEM (OPTIONAL)

The following applies to spas that have a **FRESHWATER** Salt System installed

- Press the **OPTIONS** hard button on the Control panel.
- Press the soft button next to **Salt System** to view the Salt Screen.

(See **FRESHWATER** Salt System owner's Manual for more information).

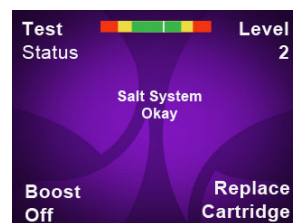
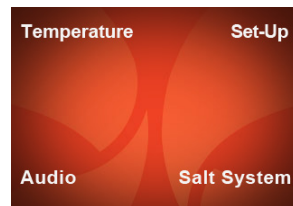

Salt System
Owner's Manual



FRESHWATER SMART MONITORING SYSTEM (OPTIONAL)

INCLUDES SALT SYSTEM

This system is a water testing system that measures pH, chlorine, and salt levels in the spa water.

Press the **OPTIONS** hard button on the Control panel followed by the **Water Care** soft button.

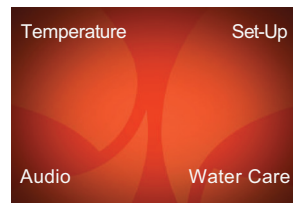

(See Smart Monitoring System Manual on CALDERA website for more information).

Press soft button next to desired description to see the indicator screen. Press the soft button next to **Next** to see the Salt System and Sensor screens where more information is available.

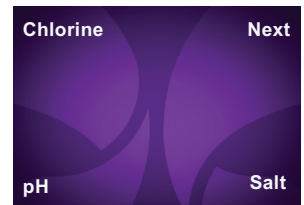

FRESHWATER DOSING SYSTEM (OPTIONAL)

The **FRESHWATER** Dosing System provides spa side dosing on command of pH Up(sodium bicarbonate) and pH Down(sodium sulfate) based on recommendations from the Smart Monitoring System. The system will also dose **FRESHWATER** Phosphate Remover into the spa based on a programmable schedule

Press the **OPTIONS** hard button on the Control panel followed by the **Water Care** soft button.

Press soft buttons next to **Next**, **Sensor**, and **Tools** to enter the Dosing screen.

(See **FRESHWATER** Dosing System Manual on **CALDERA** website for more information).

Dosing System
Owner's Manual



JETS CONTROL

The **JETS** hard button activates the jet pump(s). When the **JETS** hard button is pressed, the jets menu will be displayed on the control panel with low speed on Jet 2 turned on, the Jet Pump icon will also be displayed. Press any of the soft keys next to the description to change the jet functions between high, low speed (when available), or off.

The Jet pump icon will remain displayed until the button is pressed to turn off the jet pump(s), or after one hour of continuous operation when the pump(s) is automatically shut off by the control system.

The jet pump(s) will turn themselves off after one hour of continuous operation to prevent overheating and conserve energy. The jets can be restarted again with no delay.

You may also activate the jet pumps by pressing the **JETS** hard button as follows:



MAKENA, SALINA, MARTINIQUE, SEYCHELLES & REUNION

1st Press = Jet 2 on Low	2nd Press = Jet 2 on High
3rd Press = Both Jets on High speed	4th Press = Jet 2 on Low, Jet 1 on High
5th Press = Jet 1 on High	6th Press = Jets 1 & 2 off

KAUAI

1st press = Jet 1 on High	2nd press = Jet 1 off
---------------------------	-----------------------

LIGHT CONTROL

Press the LIGHTS hard button to activate all lights and display the Lighting Options screen.

The LIGHTS hard button can also be used to cycle through the light zones as follows:

- 1st press: Lights On
- 2nd press: Lights reduce to brightness 2
- 3rd press: Lights reduce to brightness 1
- 4th press: All Lights Off

Press the soft button next to one of the 3 lighting description to do the following:

- Turn the lights ON or OFF
- Select the color (or choose LOOP to cycle through all the colors)
- Adjust the brightness of the color with the Dimmer function.



Dimmer sequence is: Dimmer 3 = high light level, Dimmer 2 = medium light level, and Dimmer 1 = low light level.

Color sequence is: 1) Indigo 2) Aqua 3) Emerald 4) Gold 5) Ruby 6) Magenta 7) Loop On 8) Loop Off

AUDIO CONTROL (OPTIONAL WIRELESS SYSTEM ONLY)

The following applies to spas that have CALDERA wireless sound system installed:

When the sound system has been installed on the spa, the control panel can be used to control the music system. The following information demonstrates how to navigate through the audio menu by using the spa's main control panel.

AUDIO MENU

Once the sound system is installed, an **AUDIO** menu will be accessible from the Home screen.

To access the menu, press the soft button next to **Audio** on the Home screen.

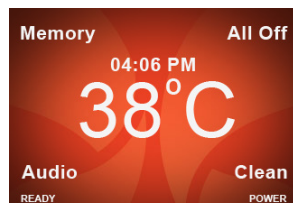

TO TURN AUDIO SYSTEM ON/OFF

From the AUDIO menu:

- Press the soft button next to **Audio** to turn the Sound System on or off. Audio must be ON to advance the audio screens.
IMPORTANT: The power can take a few seconds to turn on or off.

TO PAIR BLUETOOTH

On your device go to Bluetooth settings and find either *My Spa Music* or *My Spa BTXR*.

For *My Spa Music*:

1. Press *My Spa Music* using the standard pairing method on your mobile device.
2. Enter pairing number 0000 if asked to complete the pairing.

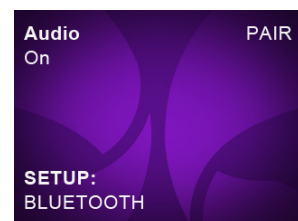

For *My Spa BTXR*:

1. Press the **Function:SET** soft button 3 times to advance to the **Enter Setup** screen. Press the **Enter Setup** soft button to advance to the **Setup Source** screen. Bluetooth should be selected.
2. Press **SETUP Source** soft button 6 times from **SETUP Source** screen to advance to the PAIR screen.
3. Press **PAIR** soft button followed by pressing "connect" next to *My Spa BTXR* on your device to pair.

On your device, find *My Spa BTXR*. If you DO NOT see this, another device may already be connected (see To Disconnect Bluetooth on following page).

TO ADJUST VOLUME

From the AUDIO menu:

- Press the soft button next to ▲ or ▼ to change the volume level.
- Press the **Function:SET** soft button to advance to the Play/Pause function screen.



NOTE: Volume range is from 0-40. No number displayed indicates Volume is OFF

TO PAUSE/PLAY (SONG)

From the AUDIO menu:

- Press the **Function:SET** soft button to advance to the Play/Pause function screen.
- Press the soft button next to **PLAY/PAUSE** (top right corner) to play or pause music.

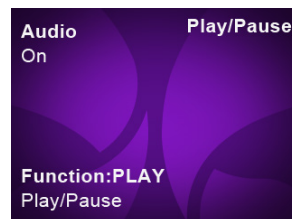

NOTE: Some audio sources will display song title.

TO CHANGE TRACK (SONG)

From the AUDIO menu:

- Press the **Function:SET** soft button to advance to the Play/Pause function screen.
- Press the **Function:PLAY Play/Pause** soft button to advance to the Track function screen.
- Press the **FORWARD** or **BACK** soft buttons to change the track (song).

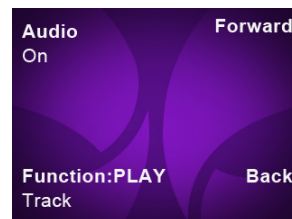

TO GO TO SETUP MENU

From the AUDIO menu:

- Press the **Function:SET** soft button to advance to the Play/Pause function screen.
- Press the **Function:PLAY Play/Pause** soft button to advance to the Track function screen.
- Press the **Function:PLAY Track** soft button to advance to the Setup function screen.
- Press the **ENTER SETUP** soft button to scroll to the **SETUP SOURCE** screen.

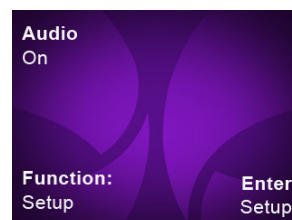

TO CHANGE AUDIO SOURCE

From the SETUP Source menu:

- This Source screen illustrates the current audio source the spa is using.
- Press ▲ or ▼ soft buttons to change the desired source: TV, AUX or Bluetooth®.

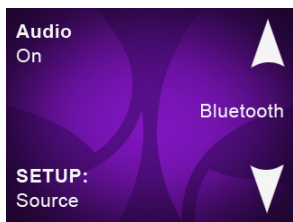

To use the Bluetooth screen, your audio Bluetooth device must be paired with the spa. Audio must be On to use Bluetooth and only one paired Bluetooth device will work at a time.

TO ADJUST TREBLE

From the SETUP Source menu:

- Press **SETUP Source** soft button to advance to the SETUP Tone, Treble screen.
- Press the soft button next to ▲ or ▼ to change the Treble between -5 and +5.



TO ADJUST BASS

From the SETUP Source menu:

- Press **SETUP Source** soft button to advance to the SETUP Tone, Treble screen.
- Press **SETUP Tone, Treble** soft button to advance to the SETUP Tone, Bass screen.
- Press the soft button next to ▲ or ▼ to change the Bass between -5 and +5.

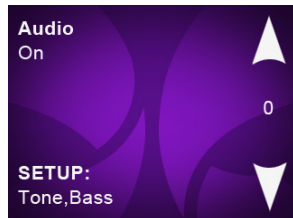

TO ADJUST BALANCE

From the SETUP Source menu:

- Press **SETUP Source** soft button to advance to the SETUP Tone, Treble screen.
- Press **SETUP Tone, Treble** soft button to advance to the SETUP Tone, Bass screen.
- Press **SETUP Tone, Bass** soft button to advance to the SETUP Balance screen.
- Press the soft button next to ▲ or ▼ to change the Balance between -5 and +5.

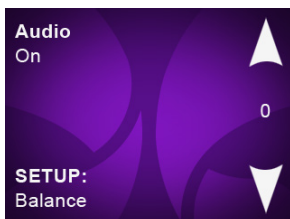

TO ADJUST SUBWOOFER

From the SETUP Source menu:

- Press **SETUP Source** soft button to advance to the SETUP Tone, Treble screen.
- Press **SETUP Tone, Treble** soft button to advance to the SETUP Tone, Bass screen.
- Press **SETUP Tone, Bass** soft button to advance to the SETUP Balance screen.
- Press **SETUP Balance** soft button to advance to the SETUP Subwoofer screen.
- Press the soft button next to ▲ or ▼ to change the Subwoofer Volume between 0 and 11.

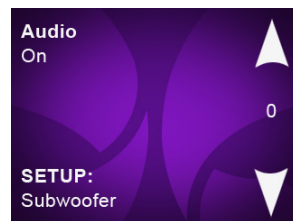

TO DISCONNECT BLUETOOTH (RESET)

From the SETUP Source menu:

- Press **SETUP Source** soft button to advance to the SETUP Tone, Treble screen.
- Press **SETUP Tone, Treble** soft button to advance to the SETUP Tone, Bass screen.
- Press **SETUP Tone, Bass** soft button to advance to the SETUP Balance screen.
- Press **SETUP Balance** soft button to advance to the SETUP Subwoofer screen.
- Press **SETUP Subwoofer** soft button to advance to the **SETUP Music Status** screen.

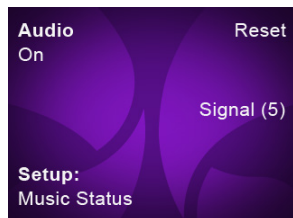

Press the soft button next to **Reset** to disconnect any device using the spa music system so that another paired device may be used. This is also necessary when trying to pair multiple devices because pairing is NOT possible when another device is connected to the music system.

- Press **SETUP Music Status** soft button to advance to the **SETUP BLUETOOTH** screen.
- See "TO PAIR BLUETOOTH" on previous page for pairing information.

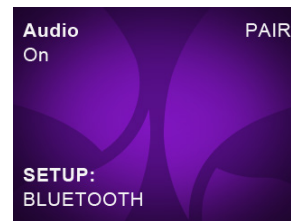

IMPORTANT: Use the BACK hardbutton to go back to the **Function:SET** screens if desired.

JET MENU

MAKENA JET SYSTEM MENU



SYSTEM 1

- a. Waterfall
- b. 2 **ADAPTAFLO** jets
Located in LumbarSsage™ Seat
- c. 5 Euro Directional jets
- d. 2 **VERSASSAGE** jets
Located in EcstaSeat™
- e. 14 Euro Directional jets



SYSTEM 2 MENU A

(Diverter in  position)

- a. 2 Euro Directional jets
 - b. 1 **VERSASSAGE** jet
- Located in UltraMassage™ lounge
- c. 6 Sole Soothers™
 - d. 3 **VERSASSAGE** jets
 - e. 4 Euro Directional jets



SYSTEM 2 MENU B

(Diverter in  position)

- a. 1 **EUPHORIA** jet
 - b. 4 Euro Directional jets
 - c. 2 Euro Directional jets
 - d. 1 **VERSASSAGE** jet
- Located in **ULTRAMASSAGE** lounge
- e. 3 **VERSASSAGE** jets
 - f. 2 Euro Directional jets

COMBINATION JET SYSTEM

Diverter in mid position activates both menus in system 2

SALINA JET SYSTEM MENU



SYSTEM 1 MENU A (Diverter in  position)

- a. 2 Euro Directional jets
- b. Waterfall

Located in **LUMBARSSAGE** Seat

- c. 5 Euro Directional jets
- d. 2 **VERSASSAGE** jets



SYSTEM 1 MENU B (Diverter in  position)

- a. 2 **ADAPTAFLO** jets
- b. Waterfall

Located in **ECSTASEAT**

- c. 14 Euro Directional jets



SYSTEM 2 MENU A (Diverter in  position)

Located in front right seat

- a. 2 **ADAPTAFLO** jets
- b. 1 **VERSASSAGE** jet

Located in front left seat

- c. 2 **VERSASSAGE** jets
- d. 4 Euro Directional jets



SYSTEM 2 MENU B (Diverter in  position)

- a. 1 **EUPHORIA** jet
- b. 2 Euro Directional jets
- c. 2 Euro Directional jets
- d. 1 **VERSASSAGE** jet

COMBINATION JET SYSTEM

Diverter in mid position activates both menus in systems 1 & 2

MARTINIQUE JET SYSTEM MENU



SYSTEM 1 MENU A

(Diverter in  position)

Located in **ULTRAMASSAGE** lounge – front

- a. 6 **SOLE SOOTHERS**
- b. 3 **VERSASSAGE** jets
- c. 6 Euro Directional jets
- d. Waterfall



SYSTEM 1 MENU B

(Diverter in  position)

a. 2 **ADAPTASSAGE** jets

b. 2 **VERSASSAGE** jets

Located in **ULTRAMASSAGE** lounge

- c. 2 Euro Directional jets
- d. 3 **VERSASSAGE** jets
- e. Waterfall



SYSTEM 2

Located in **ECSTA SEAT**

a. 8 Euro Directional jets

Located in **LUMBARSSAGE** Seat

b. 4 Euro Directional jets

c. 2 **VERSASSAGE** jets

Located in Center seat

d. 1 **ADAPTAFLO** jet

COMBINATION JET SYSTEM

Diverter in mid position activates both menus in system 1

SEYCHELLES JET SYSTEM MENU



SYSTEM 1 MENU A

(Diverter in  position)

Located in **ECSTA SEAT**

- a. 14 Euro Directional jets
- b. 1 ADAPTAFLO jet
- c. Waterfall
- d. 2 ADAPTASSAGE jets



SYSTEM 1 MENU B

(Diverter in  position)

- a. 1 ADAPTAFLO jet
- b. Waterfall
- c. 4 Euro Directional jets
- d. 2 VERSASSAGE jets
- e. 2 ADAPTASSAGE jets



SYSTEM 2 MENU A

(Diverter in  position)

Located in **ULTRAMASSAGE** lounge

- a. 6 SOLE SOOTHERS
- b. 3 VERSASSAGE jets
- c. 6 Euro Directional jets



SYSTEM 2 MENU B

(Diverter in  position)

Located in **ULTRAMASSAGE** lounge

- a. 4 Euro Directional jets
- b. 1 EUPHORIA jet
- c. 2 Euro Directional jets
- d. 3 VERSASSAGE jets

COMBINATION JET SYSTEM

Diverter in mid position activates both menus in systems 1 & 2

REUNION JET SYSTEM MENU



SYSTEM 1 MENU A (Diverter in position)

- a. 2 ADAPTASSAGE jets
Located in LUMBARSSAGE Seat
- b. 14 Euro Directional jets
- c. 1 ADAPTAFLO jet
- d. Waterfall



SYSTEM 1 MENU B (Diverter in position)

- a. 2 ADAPTASSAGE jets
- b. 1 ADAPTAFLO jet
- c. Waterfall
- Located in ECSTASEAT
- d. 4 Euro Directional jets
- e. 3 VERSASSAGE jets



SYSTEM 2 MENU A (Diverter in position)

- Located in front right seat
- a. 4 Euro Directional jets
- b. 2 VERSASSAGE jets
- c. 2 Euro Directional jets
- d. 1 VERSASSAGE jet



SYSTEM 2 MENU B (Diverter in position)

- a. 4 Euro Directional jets
- b. 2 VERSASSAGE jets
- c. 1 EUPHORIA jet
- d. 4 Euro Directional jets

COMBINATION JET SYSTEM

Diverter in mid position activates both menus in systems 1 & 2

KAUAI JET SYSTEM MENU



SYSTEM 1 MENU A

(Diverter in  position)

Located in **ULTRAMASSAGE** lounge

- a. 6 **SOLE SOOTHERS**
- b. 3 **VERSASSAGE** jets
- c. 6 Euro Directional jets

Located in **LUMBARSSAGE** seat

- d. 4 Euro Directional jets
- e. 2 **VERSASSAGE** jets

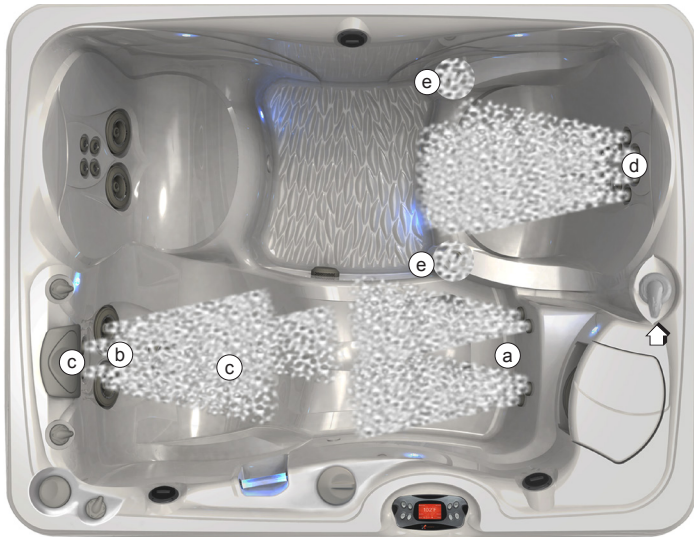

SYSTEM 1 MENU B

(Diverter in  position)

Located in **ULTRAMASSAGE** lounge

- a. 6 **SOLE SOOTHERS**
- b. 3 **VERSASSAGE** jet
- c. 6 Euro Directional jets

Located in **ECSTASEAT**

- d. 8 Euro Directional jets
- e. 2 **EURO-PULSE** jets

COMBINATION JET SYSTEM

Diverter in mid position activates both menus in system 1

SPA CARE AND MAINTENANCE

Your **CALDERA** spa is manufactured from the highest quality, most durable materials available. Even so, the spa care and maintenance program you develop will ultimately determine how long your spa, and its individual components, will last. Regular maintenance and following the advice in this section will help you to protect your investment.

FILTER MAINTENANCE

At least once a week, check and clean the skimmer basket and weir to ensure proper filter flow. Remove leaves, foreign matter, and debris. It is very important to keep your spa filter cartridge clean and free of particles to ensure proper water flow. A clean filter enables the hydrotherapy system to function properly and allows for more efficient filter cycles. Depending on how frequently your spa is used, we recommend cleaning the spa filter cartridge every four weeks. If this is not done, the filter may clog and restrict water flow, which causes improper filtration, poor jet performance and may possibly freeze.

IMPORTANT: The frequency and duration of use, and the number of occupants all contribute to determining the appropriate time between filter cleanings. More use means that more frequent filter cleanings will be required.

FILTER CARTRIDGE REMOVAL AND CLEANING INSTRUCTIONS

Turn the power to the spa off, then proceed as follows:

Push down slightly and turn filter basket counter-clockwise to unlock, then pull out the basket and floating weir.

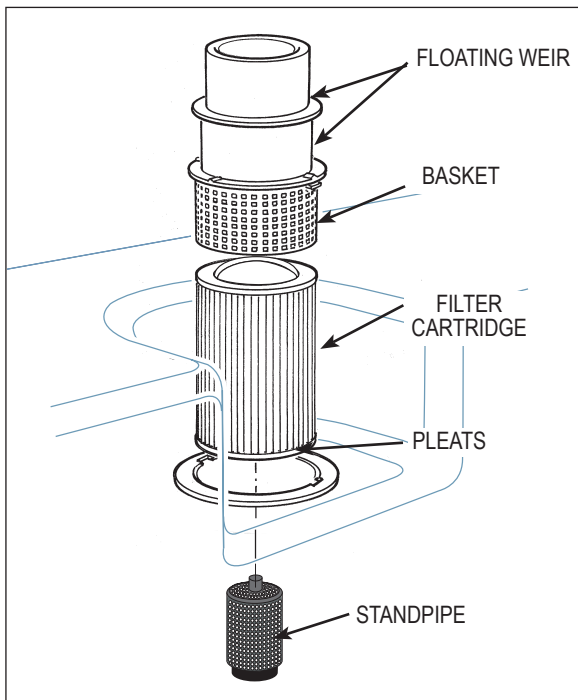

FILTER SYSTEM

Carefully pull up the filter cartridge and bring it out of the spa.

Always clean the filter using a filter degreaser to remove mineral and oil build-up. Simply soak the filter in the degreaser (according to the package directions), then place the filter on a clean surface and spray until clean using a garden hose. It may be necessary to rotate the filter while spraying to remove any debris lodged between the filter pleats. Re-insert filter cartridge.

To return basket and floating weir, insert and rotate clockwise to lock into position. Then turn spa's power back on.

NOTE: Replacement filter cartridges are available from your **CALDERA** dealer. Refer to the back of this manual to determine the appropriate size for your spa.

VERSASSAGE JET MAINTENANCE

If you notice that the **VERSASSAGE** jet spins slower than when the spa was new, or the jets are sticking, the cause may be built-up deposits inside the jet bearings. To remove the deposits, use the following instructions:

1. With the spa off, rotate the **VERSASSAGE** jet face counter-clockwise until it stops.
2. Once the face stops rotating, use a little extra force to rotate the face even more counter-clockwise past the locking position until it stops. Pull face with the body away from the spa.
3. After flushing the bearing inside the body with water, spin the rotating eye. It should spin very freely. If it does not, place the bearing end in a cup of vinegar (the vinegar will soften any deposits). Allow it to soak overnight. The next day, flush with water and repeat the spin test.

NOTE: If the jets still don't spin freely, a second night of soaking maybe required. If the bearing still does not spin, you will need to purchase a replacement assembly from your **CALDERA** dealer.

COLD WATER REFILL

- When refilling your spa if the tap water is below 10° C (50° F) the spa may go into a High Limit Protection mode (causing your spa to stop functioning). If high limit tripping does occur, the fastest way to reactivate the spa control system is to first disconnect power to the spa completely, then warm the two sensors on top of the heater and the vinyl tubing (located in the equipment compartment) with a hair dryer for approximately 10 minutes. Once you believe the sensors and heater tubing have been warmed sufficiently, reconnect power to the spa.
- Blending warm water with the cold tap water so it exceeds 10° C (50° F) during the refilling process will also achieve the same results if that is an option for you.

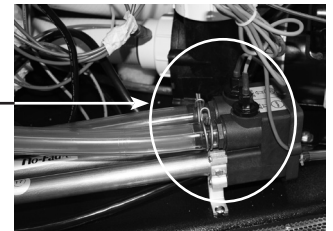

DRAINING YOUR SPA

1. Turn off all breakers in sub-panel, or main electrical panel.
2. Locate the drain valve for the spa (lower front of the spa) and remove the drain cap. Attach the inlet of a garden hose to the drain valve and route the outlet of the hose to an appropriate draining area.

NOTE: Spa water with a high sanitizer level may harm plants and grass.

3. Open the drain valve by turning the knob. The spa will drain by gravitational flow.

IMPORTANT: All models will drain almost completely through the drain valve. Equipment such as the jet pump and heating system may not completely drain. Any water remaining within the plumbing or equipment after draining will only need to be removed if the spa is being winterized.

4. After your spa is empty, clean the shell and filter cartridge.
5. Close the drain valve and reinstall the drain cap.
6. Install new filter or clean existing with filter cleaner.
7. Follow the "START-UP PROCEDURES" to refill your spa.

PREVENTION OF FREEZING

Your spa has been designed and engineered for year-round use in any climate. In some areas, extremely cold temperatures below -12°C (10°F) combined with strong wind, may cause partial freezing of the jet pump, even though the water inside the spa remains at the selected temperature. The energy efficiency of the spa may also decrease during these cold periods, as the heater will cycle more frequently. As an additional precaution against partial freezing of some of the components, the equipment compartment can be insulated with an insulating kit (available from your local dealer). This insulating kit will also help to maximize the spa's energy efficiency.

NOTE: When warmer weather returns approx. 16° - 21°C (60 - 70°F), the insulating kit must be removed to prevent overheating of the jet pump.

WINTERIZING YOUR SPA

If you leave the spa unused for a long period of time in severely cold weather, you should drain the spa and winterize it to avoid accidental freezing due to a power or equipment failure.

DANGER: Use only Propylene Glycol as your anti-freeze (available at most RV or marine supply stores). This is non-toxic. Never use an automobile anti-freeze (Ethylene Glycol) since it is toxic!

WARNING: Failure to follow these instructions correctly can lead to freeze damage not covered by warranty. It is strongly recommended that you contact your local dealer to perform this service.

1. Drain your spa following the Draining Your Spa section in the owner's manual.
2. Remove the filter cartridge, clean and store in a dry place.

IMPORTANT: These additional instructions must be utilized when draining and winterizing your spa in climates where the temperature falls below 0°C (32°F). A 19 liter (5 gallon) combination (vacuum/blower) wet/dry shop vac must be used to effectively remove water that is trapped inside the plumbing lines.

3. Attach the vacuum hose to the vacuum side of the shop vac. Vacuum all openings and orifices as follows:
 - a. Jet openings: start with the jets at the top and move downward (if suction is coming from another jet, block off the other jet using a large rag – this will help pull out the water that is trapped deeper inside the main line).
 - b. Filter suction fittings and filter compartment.
 - c. Main drain outlet (it may be necessary to cover the drain grate tightly with a rag when vacuuming the main drain to ensure water is drawn completely from the internal plumbing system).
4. Thoroughly dry the spa shell with a clean towel.
5. Remove pump door first. Once door is removed unscrew the pump drain plugs located on the front of the pump housing. Allow all water to drain out. Place the drain plugs in a ziplock bag and store near the pumps. Replace the drain plugs on Start-up.
6. Unscrew the pump unions and allow the water to drain. Loosen and remove hose attached to circulation pump to allow any remaining water from heater and spa to drain out. Replace circulation pump hose once water is drained. **NOTE:** Tighten the pump unions prior to filling the spa.
7. Replace the main drain cap.
8. Using a long-extension funnel, pour anti-freeze into all standpipes, filter suction fittings, jet orifices and water feature orifices. Add enough anti-freeze to ensure adequate protection – in many cases, you will see the liquid in the orifice, or coming out of another location.

CAUTION: Use only Propylene Glycol as your anti-freeze. This is non-toxic. Never use an automobile anti-freeze (Ethylene Glycol) since it is toxic!
9. Close the spa cover and fasten the cover tie downs. Cover the spa cover with two pieces of plywood to evenly distribute the weight of snow and ice. Secure a plastic sheet, or tarp, over the spa cover and plywood.
10. Replace the equipment access door, if removed.

OPENING INSTRUCTIONS:

1. Remove plywood and plastic sheet. Open the spa cover by unfastening the cover tie downs.
2. Follow the Start-up Procedures in the Getting Started section of the Owner's Manual. Do not install filters to prevent them from exposure to the anti-freeze.
3. As part of this process, superchlorinate the spa water by adding three teaspoons of chlorine (sodium dichlor) per 950 liters (250 gallons) of spa water into the filter compartment. This is twice the normal amount of chlorine needed for superchlorination. This extra amount of chlorine is needed to destroy the anti-freeze.

NOTE: A defoamer may be needed to decrease the amount of foam caused by the anti-freeze.
4. Drain your spa to ensure removal of anti-freeze. Do not drain water on grass or plants due to excessive chlorine level.
5. After the spa has completely drained, re-install your filter and follow the Start-up Procedures in the Getting Started section of the Owner's Manual.

IMPORTANT: Always keep spa covered when not in use, whether it is empty or full.

CARE OF THE SPA PILLOWS

The spa pillows will provide years of comfort if treated with care. They have been positioned above the water level to minimize the bleaching effects of chlorinated water and other spa water chemicals. To extend their life, whenever the spa shell is being cleaned, the spa pillows should be removed and cleaned. Body oils can be removed with a mild soap and water solution. ALWAYS rinse off the spa pillows thoroughly to remove any soap residue. If the spa is not going to be used for a long period of time (that is during a vacation or if the spa is winterized), or when the spa water is being super-chlorinated, the spa pillows should be removed until the next use of the spa.

TO REMOVE AND REPLACE THE SPA PILLOWS:

1. Carefully lift one end of the pillow away from the spa shell.
2. Continue lifting one end until all pillow retainers are released from the pillow.
IMPORTANT: Just pulling the pillow straight up and out of the shell recess will eventually damage the pillow. This abuse is not covered under warranty.
3. To reinstall the spa pillow, carefully bend the pillow slightly to allow one of the pillow retainers to slip into the recess in the back of the pillow.
4. Keeping the pillow slightly bent, slide the other pillow retainer into the recess in the back of the pillow.
5. After all the pillow retainers are in place, press the pillow down into the recess in the spa shell.

CARE OF THE EXTERIOR

SPA SHELL

Your CALDERA spa has an acrylic shell. Stains and dirt generally will not adhere to your spa's surface. A soft rag or a nylon scrubber should easily remove most dirt. Most household chemicals are harmful to your spa's shell. Always rinse off any spa shell cleaning agent with fresh water.

SPA SKIRT

When cleaning the skirt of your spa, use only a soft cloth or sponge with a mild soap and water solution. The use of an abrasive type cleaner or applicator will be harmful to the exterior finish. Always thoroughly rinse off the spa skirt with fresh water.

CARE OF THE SPA COVER

⚠ WARNING: The cover is a manual safety cover that meets or exceeds all prevailing requirements of ASTM 1346-91 for spa safety covers when installed and used correctly as of the date of manufacture. Non-secured, or improperly secured covers are a hazard.

Open the cover to its fully open position before use.

COVER CARE

The cover is made with a solution dyed polyester fabric and is an attractive, durable foam insulation product. Monthly cleaning is recommended to maintain its beauty and a longer fabric life.

To clean and condition the polyester cover:

1. Remove and gently lean against a wall or fence. If a cover lifter has been installed keep cover closed and make sure all seams are closed to prevent any soap from entering the spa.
2. With a garden hose, spray the cover to loosen and rinse away dirt or debris.
3. Add four tablespoons of mild soap or mild dishwashing liquid with 4 liters (one gallon) of lukewarm water. Clean using a soft bristle brush. Rinse thoroughly with cold water and air dry.
IMPORTANT: Do not let the polyester dry with a soap film on it before it can be rinsed clean.
4. Scrub the cover's perimeter and side flaps. Rinse clean with water.
5. Rinse off the underside of the cover with water only (use no soap), and wipe it clean with a dry rag.

IMPORTANT REMINDERS:

- **DO** remove snow buildup to avoid breakage of the foam core from the additional weight of the snow.
- **DO** lock cover lock straps to secure the cover when the spa is not in use.
- **DO NOT** drag or lift the spa cover using either the flaps or the cover lock straps.
- **DO NOT** walk, stand, or sit on the cover.
- **DO NOT** place any metal or heat transferring object on the cover or place any type of plastic tarp or drop cloth over the cover as this may result in a melted foam core, which would not be covered under the warranty.
- **DO NOT** use any lifting mechanisms, chemicals or cleaners except those recommended by Watkins Wellness or its Authorized Sales and Service Dealer.

ELECTRICAL REQUIREMENTS

ELECTRICAL REQUIREMENTS AND PRECAUTIONS

Your **CALDERA** spa has been carefully designed to give you maximum safety against electrical shock. Connecting the spa to an improperly wired circuit will negate many of the spa's safety features. Improper wiring may also cause electrocution, risk of fire, and other risks of injuries. Please read and follow the electrical installation requirements and instructions for your spa completely! Unless otherwise stipulated by your dealer, **THIS IS YOUR RESPONSIBILITY**.

SERVICE NOTE: All **CALDERA** spas have diagnostic functions that are displayed on the control panel. Four flashing lines are visible on the control panel if the heater high limit thermostat has tripped. If the four flashing lines are visible, follow the instructions in the troubleshooting section to identify and correct the cause. The four flashing lines will stop flashing once the problem has been corrected.

CALDERA SPAS MUST BE WIRED IN ACCORDANCE WITH ALL APPLICABLE NATIONAL AND LOCAL ELECTRICAL CODES. ALL ELECTRICAL WORK SHOULD BE DONE BY AN EXPERIENCED, LICENSED ELECTRICIAN. WE RECOMMEND THE USE OF APPROPRIATE ELECTRICAL CONDUIT, FITTINGS, AND WIRE FOR ALL CIRCUITS.

The **KAUAI** spa requires a 16 amp, single phase, 220-240 volt, three wire service (one line, one neutral, one ground). By using a 16 amp service, the heater will not operate whenever the jet pump is running in the high speed mode. Upgrading to a 32 amp service will allow the heater and the high speed mode of the jet pump to run simultaneously.

When upgrading the KAUAI spa to a 32 amp service, jumper JP3 must be removed from the control box prior to powering up

the spa. The **MAKENA, SALINA, MARTINIQUE, SEYCHELLES** and **REUNION** spas require a dual electrical service using a 16 & 25 amp breaker and wired per the illustration found on the next page. Additionally, one main disconnect switch with at least 3mm separation between contacts must be used for all electrical circuits to the spa.

Mount the subpanel according to local codes, but not closer than 1.5 meters (5') away. Your spa must be supplied by a residual current device (RCD) - with a tripping rating not exceeding 30 mA in an electrical subpanel.

CONDUIT INSTALLATION INSTRUCTIONS

1. To connect the electrical service, first remove the 2 screws from the equipment compartment door. Slightly pull the door panel out from the bottom using the notches in the door panel on one side then the other, then lower and remove door panel from the spa.
2. Locate the control box. Loosen the screws on the front of the control box. Remove the screws and the control box cover.
3. Insert power wires into access opening from either side below the front corner, you will find a plastic cap attached to spa.
4. Connect the supply conduit to the control box and connect the wiring as detailed below and on the wiring diagram label on the inside of the control box cover.

⚠ WARNING: Removing or bypassing any RCD breaker will result in an unsafe spa and will void the spa's warranty.

IMPORTANT: Should you ever find the need to move or relocate your **CALDERA** spa, it is essential that you understand and apply these installation requirements. Your **CALDERA** spa has been carefully engineered to provide maximum safety against electric shock. Remember, connecting the spa to an improperly wired circuit will negate many of its safety features.

NOTE: Long wiring runs may require larger-gauge wire than stated.

WIRING DIAGRAMS

MAKENA • SALINA • MARTINIQUE • SEYCHELLES • REUNION

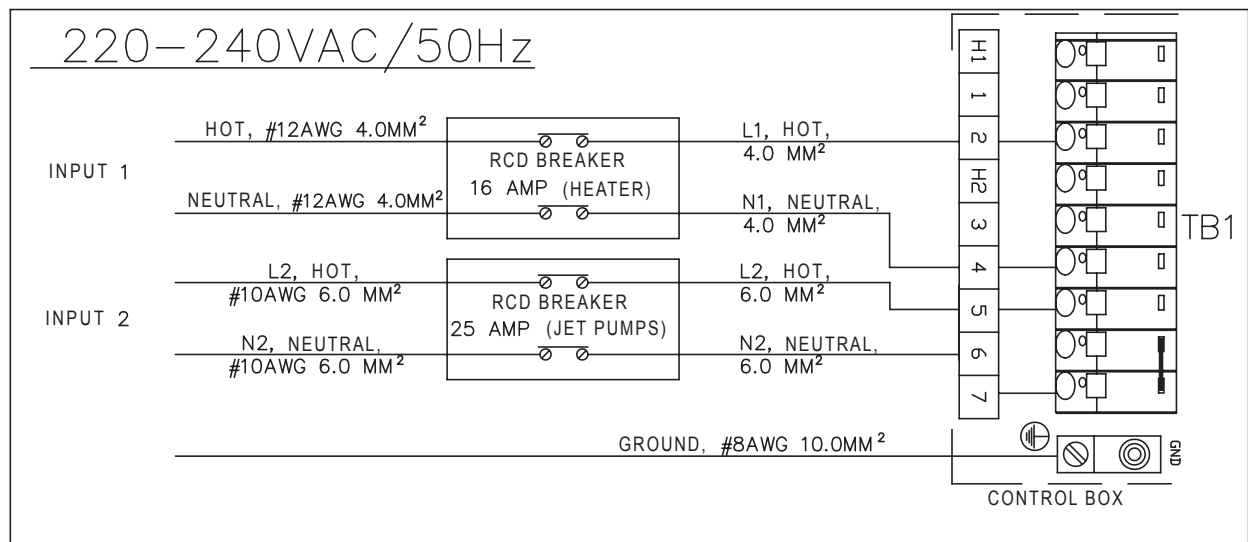

KAUAI

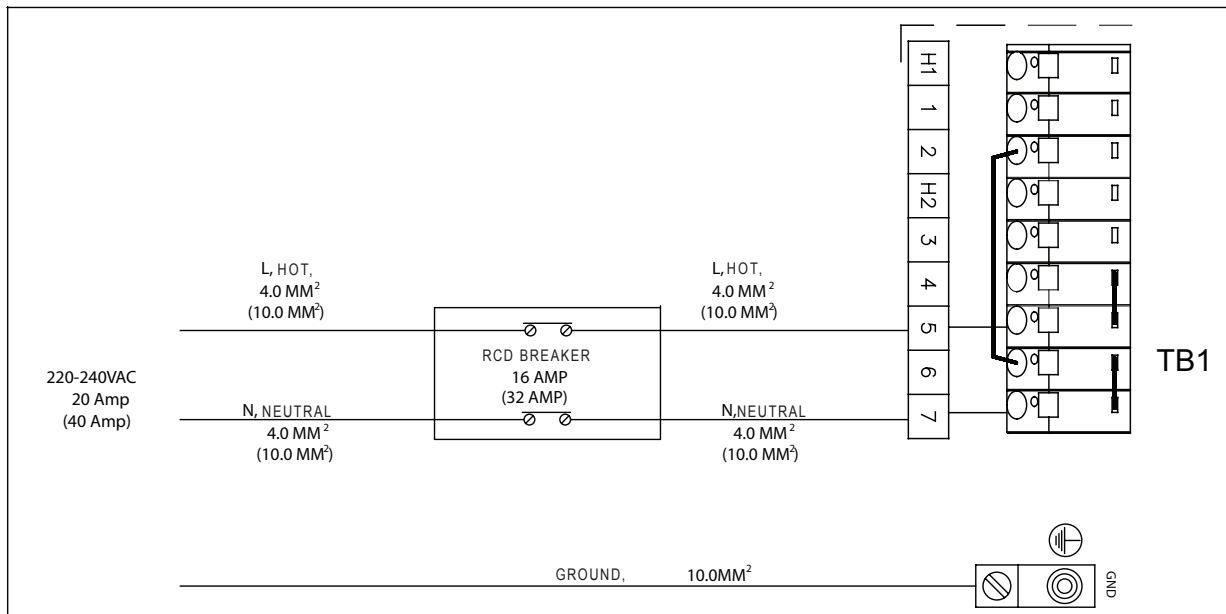

NOTES: Connect supply wiring as shown in the diagrams above.
Connect only to a circuit which is protected by a RCD (Residual Current Device).

EQUIPMENT COMPARTMENT

The illustration below is to be used as a reference only (your spa may look different). The equipment compartment is located behind the front panel of the spa below the Main Control Panel.

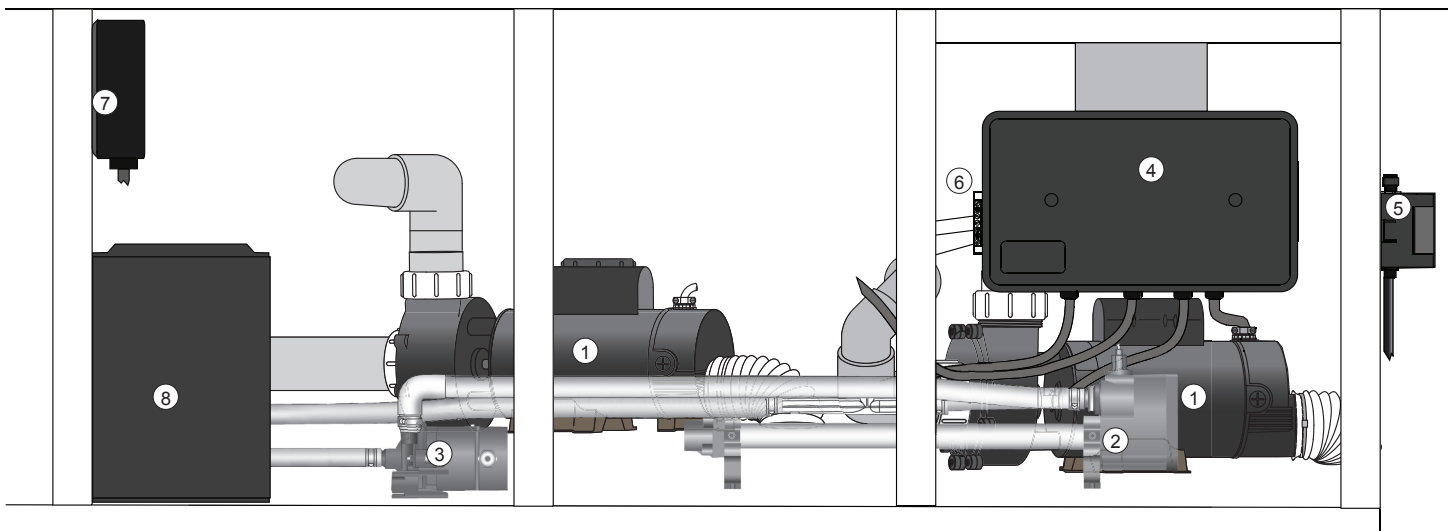

- | | |
|---------------------------------------|-------------------------------|
| 1. Jet pump* | 5. Ozone Generator (optional) |
| 2. EnergyPro® heater | 6. Bonding terminal |
| 3. ENERGY PRO Circulation Pump | 7. Bluetooth Music (optional) |
| 4. Advent® Control Box | 8. Subwoofer (optional) |

INSTALLATION

SITE PREPARATION

You probably have a spot picked out for your new spa, whether it's indoors or outdoors, on a patio or on a deck. Please make sure you check the following:

- Always put your spa on a structurally sound, level surface. A filled spa can weigh a great deal. Make certain that the location you choose can support the weight of your filled spa.
- Don't forget to level your spa before filling it. (See the Spa Leveling Preparation.)
- Locate your equipment compartment, which houses all of the electrical components, in a place where water will drain away from it. Allowing water into the equipment compartment can damage the electronics, or may result in tripping your house's circuit breaker.
- Leave yourself easy access to the circuit breakers in the subpanel.
- Leave access to the equipment compartment for periodic spa care and maintenance.

⚠ **WARNING: Damage to the spa's equipment compartment components or internal plumbing as a result of rodent infestation is NOT covered under your warranty!**

OUTDOOR AND PATIO INSTALLATION

No matter where you install your new spa, it's important that you have a solid foundation to support it. Structural damage to the spa, resulting from incorrect installation, or placement on an inadequate foundation, is not covered under the spa's limited warranty.

If you install the spa outdoors, we recommend a reinforced concrete pad at least four inches thick. The reinforcing rod or mesh in the pad should be attached to a bond wire.

DECK INSTALLATION

To be certain your deck can support your spa, you must know the deck's maximum load capacity. Consult a qualified building contractor or structural engineer. To find the weight of your spa, its contents and occupants, refer to the Spa Specification chart on back cover. This weight per square foot must not exceed the structure's rated capacity, or serious structural damage could result.

INDOOR/BASEMENT INSTALLATION

Be aware of some special requirements if you place your spa indoors. Water will accumulate around the spa, so flooring materials must provide a good grip when wet. Proper drainage is essential to prevent a build-up of water around the spa. When building a new room for the spa it is recommended that a floor drain be installed. The humidity will naturally increase with the spa indoors. Water may get into woodwork and produce dry rot, mildew, or other problems. Check for airborne moisture's effects on exposed wood, paper, etc. in the room. To minimize these effects, it is best to provide plenty of ventilation to the spa area. An architect can help to determine if more ventilation must be installed.

Find the vent and be sure the vent is not blocked by anything, including carpeting.

Your **CALDERA** dealer can help you with local information such as zoning regulations and building codes.

⚠ **WARNING: Please keep the area around your spa well ventilated when it is installed indoors or in a confined area.**

Inadequate ventilation around the spa could cause a build-up of a higher-than-normal concentration of spa chemicals and/or bacterial fragments. These dispersed spa chemicals and/or bacterial fragments can be inhaled, and may result in breathing difficulties or lung damage in certain people suffering from a compromised immune system or respiratory infection. If you or other bathers are affected by this condition, please seek medical attention as soon as possible.

In addition to the above, properly clean and maintain your spa as follows:

- Follow all procedures in this owner's manual and printed instructions on all water care (chemical) products packaging.
- Test the water regularly to ensure proper levels of sanitizers, pH, and other water care requirements.
- Drain, clean, and refill your spa with fresh water on a regular schedule, and in accordance with this owner's manual.
- Clean the filter at least once per month.
- Check to make sure you have proper circulation throughout your spa water system.
- Have spa users bathe before entering the spa water.

SPA LEVELING PREPARATION

Concrete sloped at 1.5 cm per 3 m (.5" per 10') is preferred so that rain water and water spillover will run off and not puddle underneath the spa (water under the spa for long periods of time may cause the wood to deteriorate). Other options are brick, stepping stone, or blocks.

It is important to note that soft surfaces, even when stepping stones are used to evenly distribute the weight of the spa, will have a tendency to settle, thus resulting in an unlevel spa.

NOTE: Placing the spa on grass or dirt may increase the amount of debris which is inadvertently brought into the spa water and may cause harm to your equipment as well as the spa surface, which is not covered under warranty.

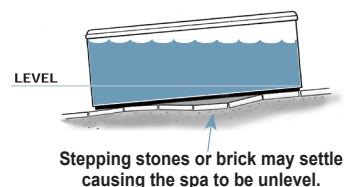
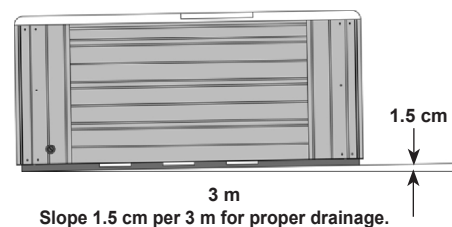

SPA COVER INSTALLATION

1. Place the cover squarely on the spa.
2. Position the tie-down locks included with your cover on the side of the spa so that they are easily reached by the cover tie-down straps. Allow for about 1.5 - 2 cm (1/2" to 3/4") slack in the straps to make it easy to insert straps into locks and to compensate for shrinkage in cold weather.
3. Attach the locks with the screws provided and insert the cover tie-down straps into the locks.

NOTE: Keeping the cover in place any time the spa is not in use will reduce the amount of time the heater operates, thereby minimizing operating costs.

Your **CALDERA** spa has been thoroughly tested during the manufacturing process to ensure reliability and long-term customer satisfaction. A small amount of water may have remained in the plumbing after testing and, as a result, may have spotted the spa shell or the spa siding prior to delivery. Before filling the spa, wipe the spa shell clean with a soft rag. The following instructions must be read and followed exactly to ensure a successful start-up or refill.

DELIVERY ACCESS

NOTE: It may be necessary to allow for additional over-head clearance if the spa will be rolled up or down an incline or moved up or down a short flight of stairs.

Use the information in the chart on the next page to determine the requirements for access to your desired location. It may be necessary to remove a gate, part of a fence, or other movable obstructions in order to roll the spa to its installation site. About ten percent of the time, a crane is the only way to install the spa by lifting it to its final destination.

If the spa has to be taken off of the cart to go over a wall (either because the entry area is too narrow, the eaves are too low, the corner is too tight, or the stairway is too steep), a crane will be required. Don't be alarmed!

The crane has a truck-mounted boom which can fit right in your driveway. It is run by a licensed and insured operator. For a charge, the crane operator will lift your spa over walls, buildings, or any other obstruction and place it as close to the installation site as possible. The **CALDERA** spa delivery personnel will supervise the crane delivery and complete the spa installation. Crane delivery typically takes an average of 30 minutes to complete.

NOTE: If your spa delivery requires the use of a crane, you may be required to pay for its services at the completion of the delivery.

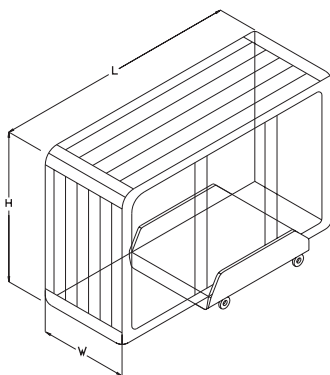

SPA DIMENSIONS

Model	Width (W)	Length (L)	Height (H)
MAKENA	91 cm (36")	226 cm (7'5")	226 cm (7'5")
SALINA	91 cm (36")	226 cm (7'5")	226 cm (7'5")
MARTINIQUE	88 cm (34")	226 cm (7'5")	193 cm (6'4")
SEYCHELLES	91 cm (36")	213 cm (7'0")	213 cm (7'0")
REUNION	91 cm (36")	213 cm (7'0")	213 cm (7'0")
KAUAI	75 cm (29.5")	213 cm (7'0")	165 cm (5'5")

COVER INSTALLATION

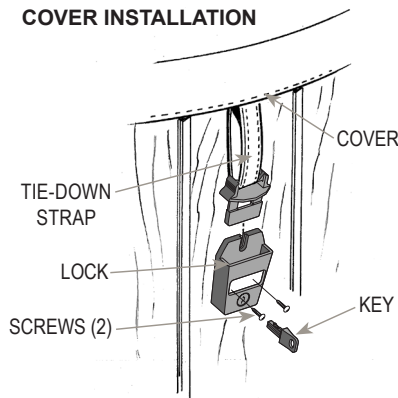

DANGER. RISK OF INJURY.

- Never leave a spa uncovered or unattended.
- Never leave a spa cover unlocked.
- Do not stand, sit, or lie on the cover.

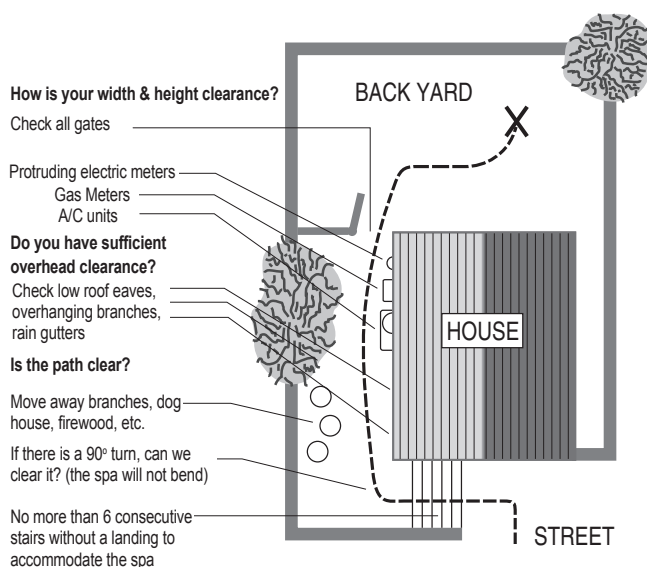

POWER CONNECTION ACCESS

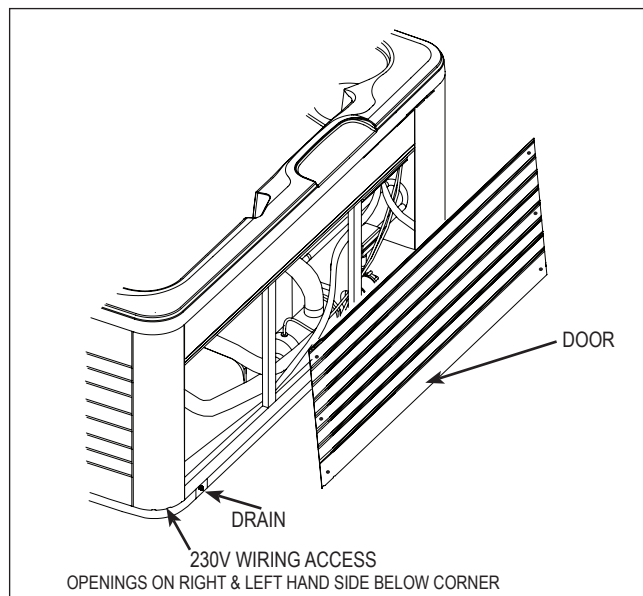

MAKENA AND SALINA DIMENSIONS

NOTE: All dimensions are approximate; measure your spa before making critical design or pathway decisions.

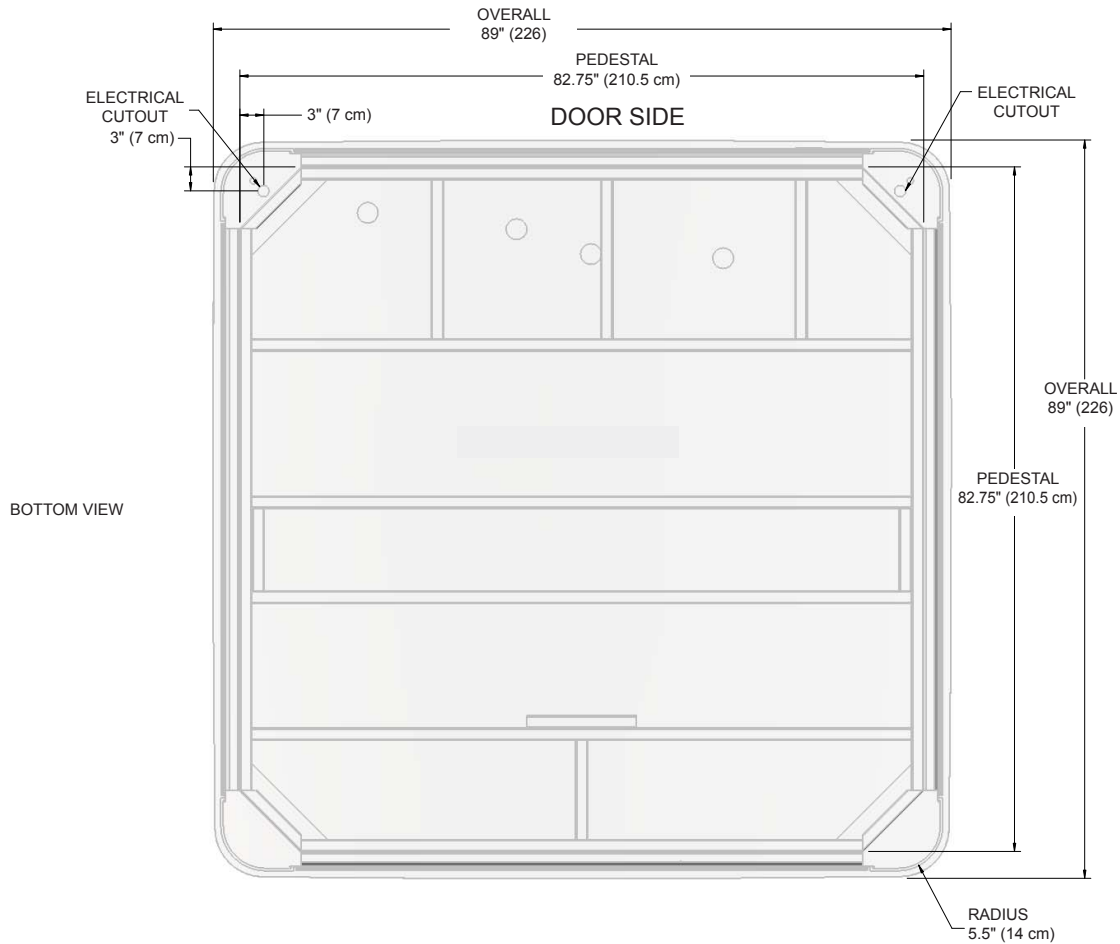
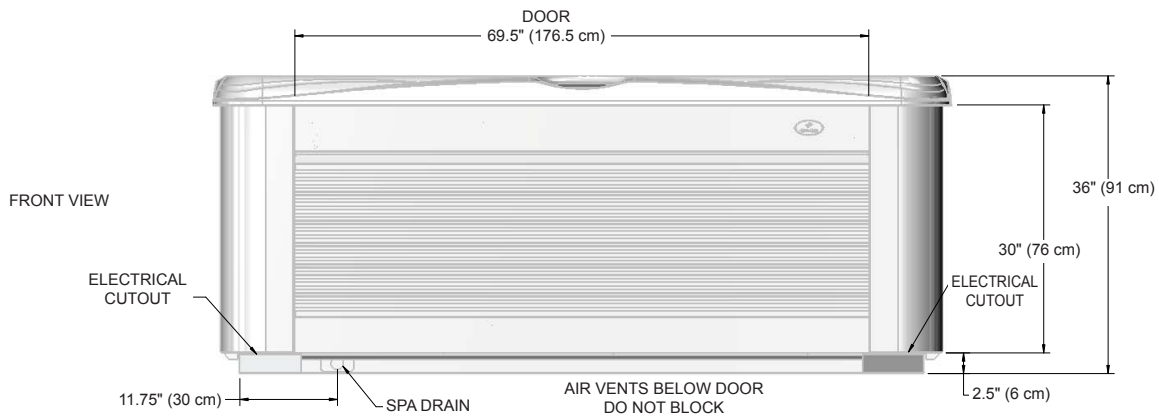

NOTE: Watkins Wellness requires that the **MAKENA** and **SALINA** be installed on a minimum 10 cm (4") thick reinforced concrete pad or structurally sound deck able to support the "dead weight" found in the spa specification chart.

WARNING: The **MAKENA** and **SALINA** must not be shimmed in any manner.

MARTINIQUE

NOTE: All dimensions are approximate; measure your spa before making critical design or pathway decisions.

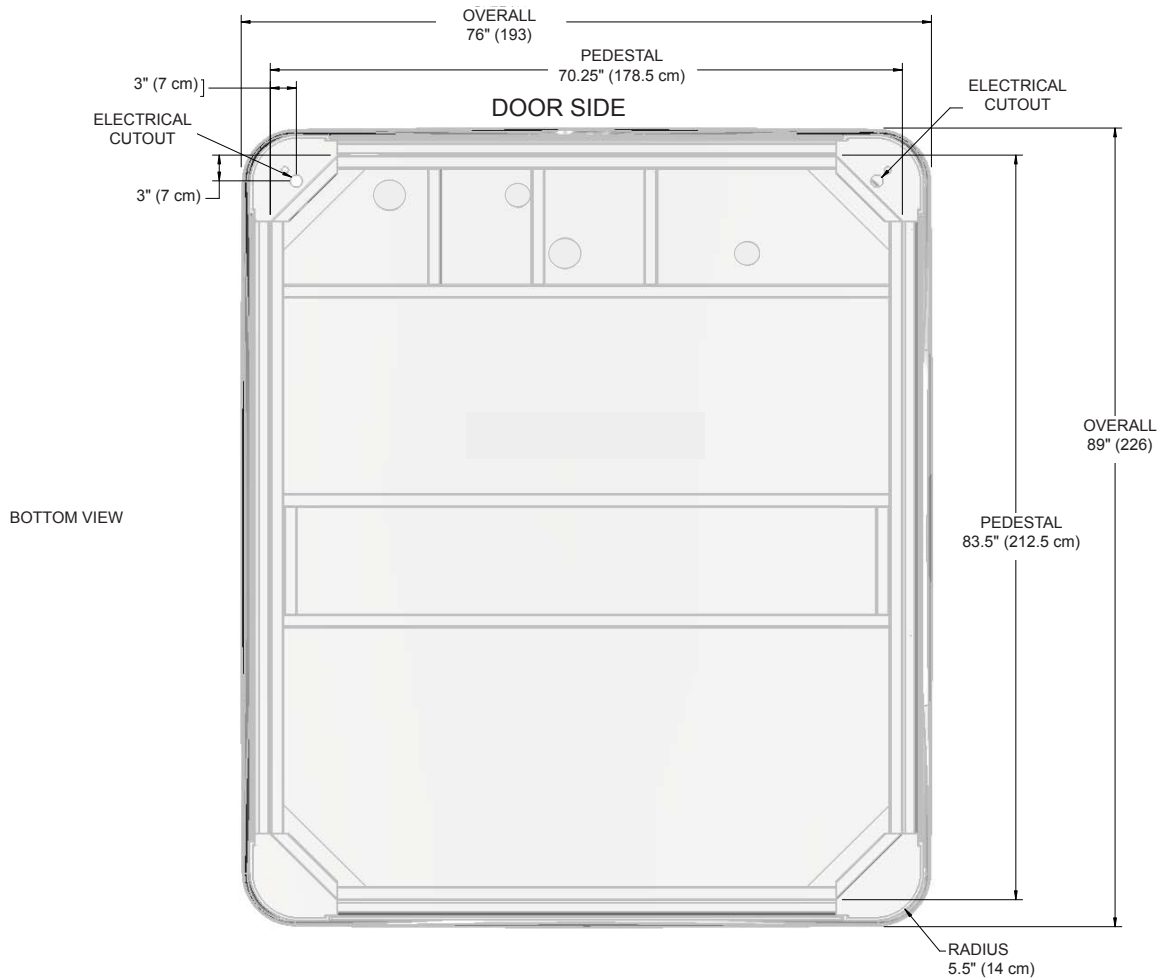
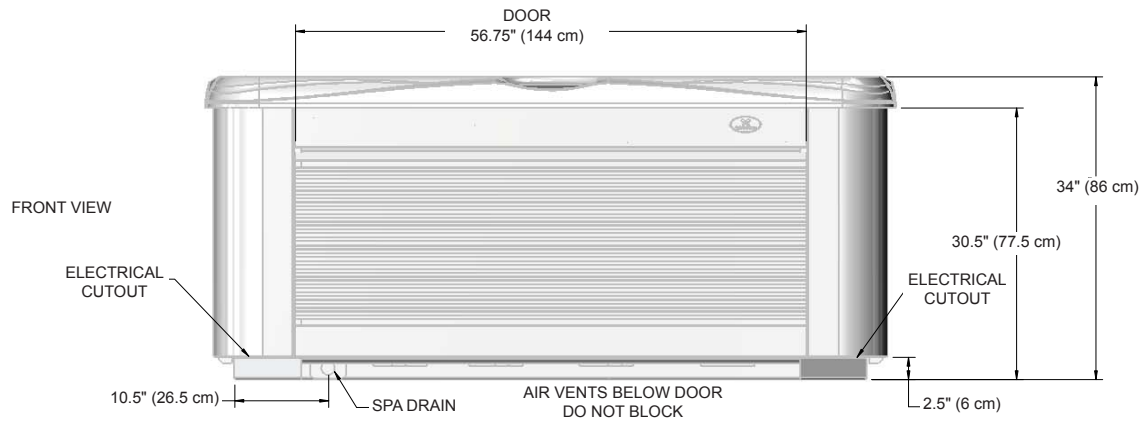

NOTE: Watkins Wellness recommends that the **MARTINIQUE** be installed on a minimum 10 cm (4") thick reinforced concrete pad or structurally sound deck able to support the "dead weight" found in the spa specification chart.

WARNING: The **MARTINIQUE** must not be shimmed in any manner.

SEYCHELLES

NOTE: All dimensions are approximate; measure your spa before making critical design or pathway decisions.

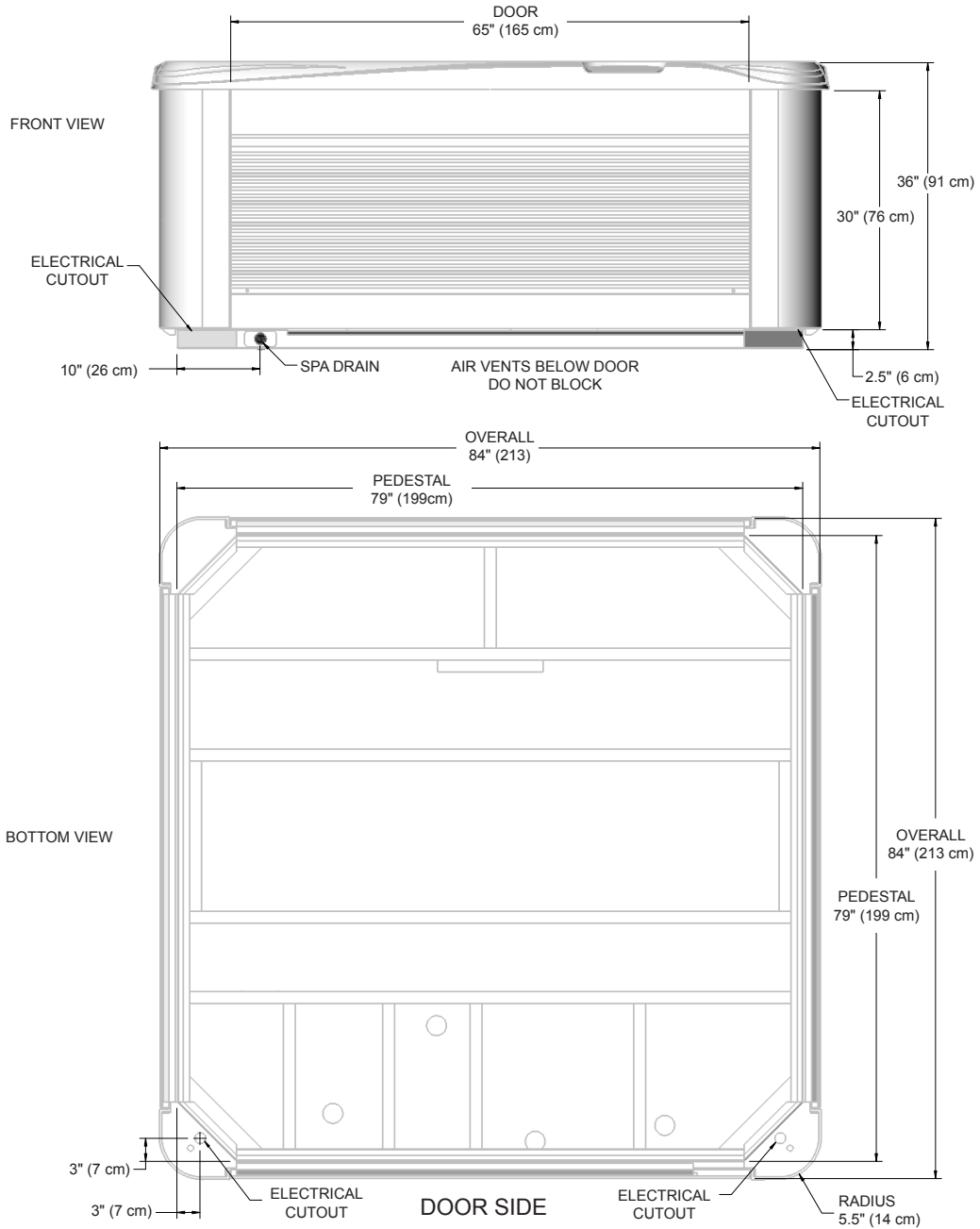

NOTE: Watkins Wellness recommends that the **SEYCHELLES** be installed on a minimum 10 cm (4") thick reinforced concrete pad or structurally sound deck able to support the "dead weight" found in the spa specification chart.

WARNING: The **SEYCHELLES** must not be shimmed in any manner.

REUNION

NOTE: All dimensions are approximate; measure your spa before making critical design or pathway decisions.

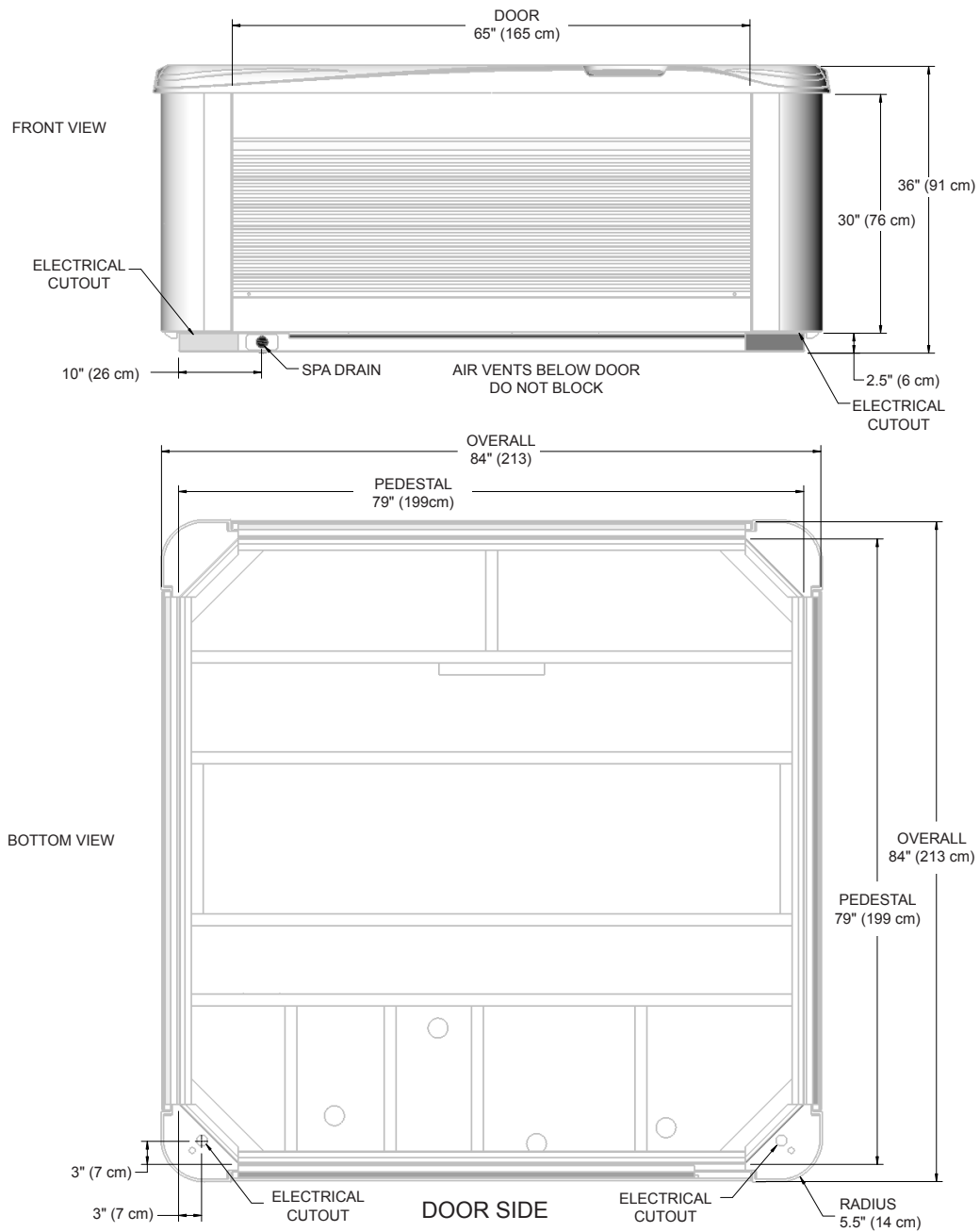

NOTE: Watkins Wellness recommends that the **REUNION** be installed on a minimum 10 cm (4") thick reinforced concrete pad or structurally sound deck able to support the "dead weight" found in the spa specification chart.

WARNING: The **REUNION** must not be shimmed in any manner.

KAUAI

NOTE: All dimensions are approximate; measure your spa before making critical design or pathway decisions.

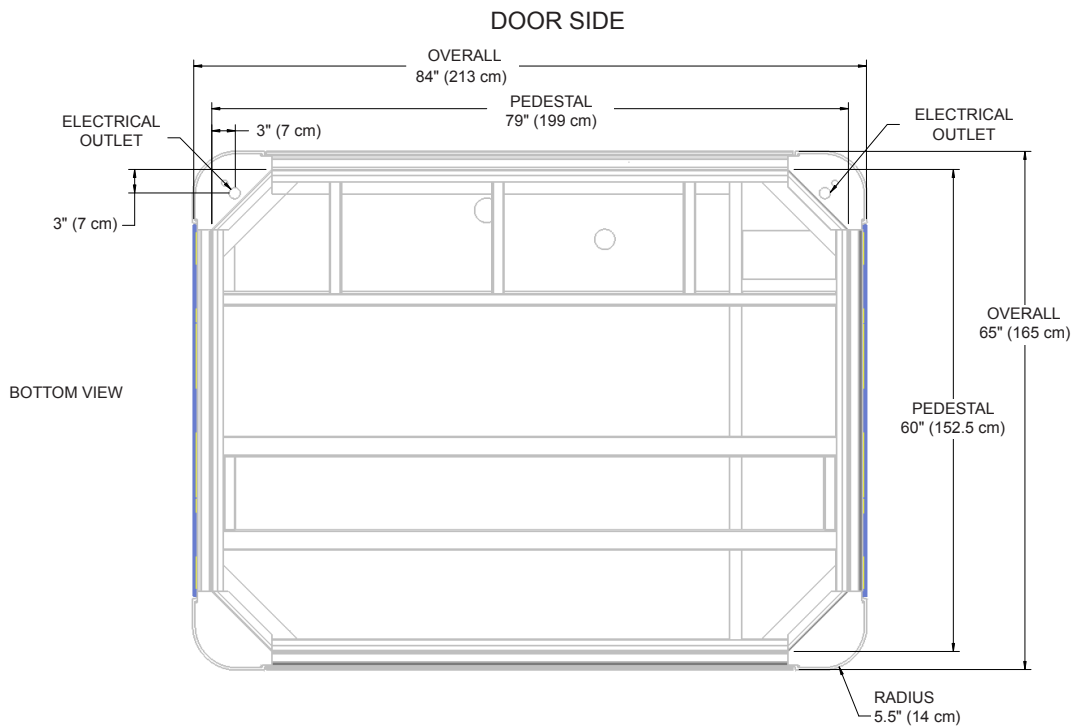
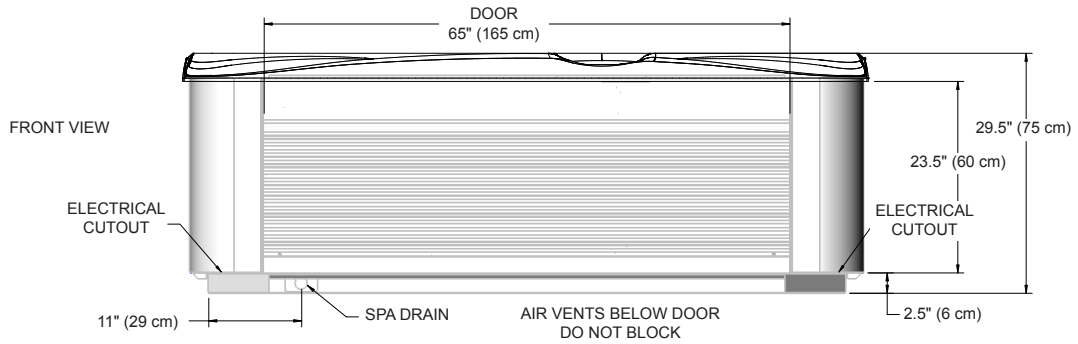

NOTE: Watkins Wellness recommends that the **KAUAI** be installed on a minimum 10 cm (4") thick reinforced concrete pad or structurally sound deck able to support the "dead weight" found in the spa specification chart.

WARNING: The **KAUAI** must not be shimmed in any manner.

SERVICE INFORMATION

GENERAL INFORMATION

Your **CALDERA** spa has been designed to provide years of trouble-free use. As with any appliance, problems may occasionally occur that require the expertise of a qualified service person. Though such simple repairs as resetting a RCD breaker, or resetting a high limit thermostat may not require a service call, they may indicate that a more serious condition exists. These conditions may require an experienced service person. Before calling for service, please refer to the Troubleshooting Guide. Always retain your original sales receipt for future reference.

RCD AND HIGH LIMIT THERMOSTAT

If your spa fails to operate at any time, first check the power supply to the spa.

Check each of the RCD breakers in the subpanel. If a RCD has tripped, reset it. If it will not reset, this may be an indication of a ground fault (short circuit) within the electrical components. Contact an Authorized Service Technician for a complete diagnosis.

If upon checking the RCD's you find that they have not tripped, check the house breaker panel and ensure the main breaker for the electrical circuit supplying the spa has not tripped. If it has, this is an indication that the circuit was either overloaded or a ground fault exists between the breaker panel and the spa receptacle or subpanel. Contact a qualified electrician.

If upon checking the main house breaker and spa RCD's you find no failures, check the high limit thermostat. To check it, simply turn off power to the spa for 30 seconds. This will automatically reset the high limit thermostat if it has tripped. If the spa energizes once you turn the power back on, this indicates reduced water flow through the heating system. Tripping of the high limit thermostat is normally a result of one or a combination of these problems. 1) clogged filter cartridge(s), 2) blockage within the system plumbing, 3) a non-functioning heater circulation pump, 4) power was not disconnected from the spa before it was drained, 5) an air lock in the plumbing lines. (The Power Indicator on the front of the spa's control panel will also be blinking if the high limit thermostat circuit has tripped.)

If the spa does not function after tripping and resetting the RCD's or resetting the high limit thermostat, then the problem should be referred to an Authorized Service Technician. Refer to the Troubleshooting Guide for additional service information.

HEATER AND INTEGRATED PRESSURE SWITCH

Watkins Wellness unconditionally warrants the heater against any failure that would require replacement. This warranty's duration is equal to the time period identified in the Heater Warranty. This warranty defines unconditional as warranty coverage without exception provided that the component has failed to operate properly within the spa's system. This means that conditions that would normally invalidate the limited warranty, such as water chemistry damage, do not apply to the heater.

It is important to note that the heater is protected by both the heater high limit thermostat circuit and the integrated pressure switch. The causes of heater high limit tripping are discussed in the previous section.

If the spa is not heating, the red and green lights are blinking, but the pump and light are operating, then the pressure switch may be open. Opening of the pressure switch is normally a result of one or a combination of these problems:

1. A clogged filter cartridge
2. Blockage within the system plumbing
3. Power was not disconnected to the spa before it was drained
4. An air lock in the plumbing lines
5. Circulation pump not properly working

Once the problem has been identified and corrected the pressure switch will close which will energize the heater.

CIRCULATION PUMP AND CIRCULATION PUMP THERMAL CUT-OFF

The circulation pump is a dedicated, water cooled, energy efficient, quiet pump that provides continuous filtration for the spa. Since the pump is water cooled, it is equipped with a thermal cut-off to prevent the pump from being damaged by running hot when water is not present.

Reset the circulation pump's thermal cut-off by disconnecting power to the spa and allowing the pump to cool.

Tripping of the thermal cut-off is normally the result of one or a combination of these problems: 1) clogged filter cartridge(s), 2) blockage within the system plumbing, 3) power was not disconnected to the spa before it was drained, or 4) an air lock in the plumbing lines. Once the problem has been identified and corrected the pump thermal cut-off will be able to be reset which will allow it to operate normally.

MISCELLANEOUS SERVICE INFORMATION

The control and high-limit thermostats are equipped with electronic sensors that are connected to the spa's plumbing. Never cut or kink the wires that connect the sensors to the thermostats within the control box.

The jet pump is equipped with a thermal overload cutoff switch that is designed to protect the pump from overheating. If the pump shuts itself off in an older spa, it could indicate failure of the pump motor bearings. If the pump shuts itself off in a new spa, it is usually the result of one or a combination of the following factors:

- Thermal overload: Although mass-produced, not all thermal overload cutoffs are exactly the same. Some are more sensitive than others and will shut the pump off at lower temperatures.
- High temperature: If the vent is blocked by masonry, grass or debris, overheating of the jet pump may occur. Once the pump motor has cooled sufficiently and any blockage has been removed from the vent opening, the jet pump can be restarted.
- Friction: Sometimes the moving parts of a new pump are tight enough to cause heat build-up due to friction. After a normal break-in period, the pump will run cooler.
- Improper wiring: If the spa is connected with an extension cord, and/or the house wiring is undersized, the pump may starve for voltage and therefore may draw more amperage and generate excessive heat.
- If the pump is shutting down due to excessive heat, make sure the equipment compartment has adequate ventilation. The air gap at the bottom must not be blocked. Should your jet pump continue to shut off after short periods of use, contact a qualified service technician.

ACTS INVALIDATING WARRANTY

The limited warranty is void if the **CALDERA** spa has been improperly installed, subjected to alteration, misuse, or abuse, or if any repairs on the spa are attempted by anyone other than an authorized representative of Watkins Wellness. Alteration shall include any component or plumbing change, electrical conversion, or the addition of any non-approved sanitation or water purification device or heating system which contributes to component or unit failure or unsafe operating system. Misuse and abuse shall include any operation of the spa other than in accordance with Watkins Wellness printed instructions, or use of the spa in an application for which it is not designed; specifically: use of the spa in a non-residential application; damage caused by operation* of the spa at water temperatures outside the range of 1.5°C (35°F) and 49°C (120°F); damage caused by a dirty, clogged or calcified filter cartridge; damage to the spa surface caused by the use of tri-chloro chlorine, BCDMH, misuse of chemical tablets in a floater, acid, or any other spa chemicals or spa surface cleaners which are not recommended by Watkins Wellness; damage caused by allowing undissolved spa sanitizing chemicals to lie on the spa surface (no spa surface material can withstand this kind of abuse); damage to components or spa surface caused by improper water chemistry maintenance; and damage to the spa surface caused by leaving the spa uncovered while empty of water and in direct exposure to sunlight (this may cause solar heating distress in warm weather regions). These are considered abuses and may invalidate this warranty.

*Operation of the spa does not mean “use” of the spa! Watkins Wellness does not recommend using the spa if the water temperature is above or below the spa’s control panel temperature range.

DISCLAIMERS

Watkins Wellness shall not be liable for loss of use of the **CALDERA** spa, or other incidental, consequential, special, indirect, or punitive costs, expenses or damages, which may include but are not limited to the removal of a permanent deck or other custom fixture, or the necessity for crane removal. Any implied warranty shall have a duration equal to the duration of the applicable limited warranty stated above. Some states do not allow limitations on how long an implied warranty lasts. Under no circumstances shall Watkins Wellness or any of its representatives be held liable for injury to any person or damage to any property, however arising.

Some states do not allow the exclusion or limitation of incidental or consequential damages, so the above limitations may not apply to you.

CUSTOMER SERVICE

If you have any questions about any aspect of your **CALDERA** spa set-up, operation, or maintenance that have not been answered by this manual, consult your **CALDERA** dealer.

TROUBLESHOOTING

Should you experience any problem whatsoever, do not hesitate to contact your authorized **CALDERA** dealer. Located below and on the next page are some tips to help you to diagnose and rectify some more common sources of trouble yourself, if you choose to do so.

SPA WATER MAINTENANCE TROUBLESHOOTING GUIDE

Problem	Probable causes	Solutions
Cloudy Water	<ul style="list-style-type: none"> • Dirty filters • Excessive oils / organic matter • Improper sanitization • Suspended particles / organic matter • Overused or old water 	<ul style="list-style-type: none"> • Clean filters • Shock spa with sanitizer • Add sanitizer • Adjust pH and/or alkalinity to recommended range • Run jet pump(s) and clean filters • Drain and refill the spa
Water Odor	<ul style="list-style-type: none"> • Excessive organics in water • Improper sanitization • Low pH 	<ul style="list-style-type: none"> • Shock spa with sanitizer • Add sanitizer • Adjust pH to recommended range
Chlorine Odor	<ul style="list-style-type: none"> • Chloramine level too high • Low pH 	<ul style="list-style-type: none"> • Shock spa with sanitizer • Adjust pH to recommended range
Musty Odor	<ul style="list-style-type: none"> • Bacteria or algae growth 	<ul style="list-style-type: none"> • Shock spa with sanitizer—if problem is visible or persistent, drain, clean and refill the spa
Organic buildup / scum ring around spa	<ul style="list-style-type: none"> • Build-up of oils and dirt 	<ul style="list-style-type: none"> • Wipe off scum with clean rag – if severe, drain the spa, use a spa surface and tile cleaner to remove the scum, and refill the spa
Algae Growth	<ul style="list-style-type: none"> • High pH • Low sanitizer level 	<ul style="list-style-type: none"> • Shock spa with sanitizer and adjust pH • Shock spa with sanitizer and maintain sanitizer level
Eye Irritation	<ul style="list-style-type: none"> • Low pH • Low sanitizer level 	<ul style="list-style-type: none"> • Adjust pH • Shock spa with sanitizer and maintain sanitizer level
Skin Irritation / Rash	<ul style="list-style-type: none"> • Unsanitary water • Free chlorine level above 5 ppm 	<ul style="list-style-type: none"> • Shock spa with sanitizer and maintain sanitizer level • Allow free chlorine level to drop below 5 ppm before spa use
Stains	<ul style="list-style-type: none"> • Total alkalinity and/or pH too low • High iron or copper in source water 	<ul style="list-style-type: none"> • Adjust total alkalinity and/or pH • Use a metal deposit inhibitor
Scale	<ul style="list-style-type: none"> • High calcium content in water – total alkalinity and pH too high 	<ul style="list-style-type: none"> • Adjust total alkalinity and pH – if scale requires removal, drain the spa, scrub off the scale, refill the spa and balance the water

GENERAL OPERATION TROUBLESHOOTING GUIDE

Problem	Probable causes	Solutions
Entire spa is inoperative	<ul style="list-style-type: none"> • Power failure • RCD tripped • Heater high limited thermostat tripped • Spa Lock activated 	<ul style="list-style-type: none"> • Check power source • Reset RCD; call for service if it will not reset. • Disconnect power for at least thirty seconds to reset heater high limit. If it will not reset, check for clogged filters. If tripping continues, call for service. • Deactivate Spa Lock
Jets weak or surging	<ul style="list-style-type: none"> • Spa water level too low • Filter clogged • Air valves are closed 	<ul style="list-style-type: none"> • Add water • Clean filter • Open air valves
Light inoperative	<ul style="list-style-type: none"> • Spa Lock activated • Light assembly is faulty 	<ul style="list-style-type: none"> • Deactivate Spa Lock • Call for service
Both Power and Ready Indicators Blinking	<ul style="list-style-type: none"> • Dirty filter • Low water level • Pressure switch problem • Temperature sensor problem 	<ul style="list-style-type: none"> • Clean filter • See Start Up section in Owner's Manual • Disconnect power for at least thirty seconds. If flashing continues after power up, call for service
Power Indicator Blinking with four lines in display area	<ul style="list-style-type: none"> • Heater high limit thermostat tripped 	<ul style="list-style-type: none"> • Disconnect power for at least thirty seconds to reset heater high limit. If it will not reset, check for clogged filter. If tripping continues, call for service
Ready Indicator Blinking	<ul style="list-style-type: none"> • Temperature sensor problem 	<ul style="list-style-type: none"> • Disconnect power for at least thirty seconds. If blinking continues after power up, call for service
Spa not heating properly	<ul style="list-style-type: none"> • Temperature set too low • Spa cover improperly positioned • Dirty filter • Summer Timer on 	<ul style="list-style-type: none"> • Set control panel to a higher temperature. • Align spa cover • Clean filter • Turn summer timer mode to off position
Pump motor will not function	<ul style="list-style-type: none"> • Motor overload condition • Control switch failure if jet symbol does not come on 	<ul style="list-style-type: none"> • Let cool for one hour. Motor overload will reset automatically. If problem persists, contact your CALDERA dealer • Disconnect spa and contact your CALDERA dealer
Surging pump or motor	<ul style="list-style-type: none"> • Low water level 	<ul style="list-style-type: none"> • Add water to normal level (2.5 cm [1"] above highest jet)
Pump motor runs, but low or no water/jet pressure	<ul style="list-style-type: none"> • Air control valve closed or blocked • Low water level • Dirty filter cartridge • Jet blocked • Clogged suction or skimmer basket 	<ul style="list-style-type: none"> • Open or clean air valve • Add water to normal level (2.5 cm [1"] above highest jet) • Clean filter cartridge • Remove jet face eyeball and clean orifice • Clean suction cover or skimmer basket
Diverter valves are difficult to turn	<ul style="list-style-type: none"> • Sand or grit inside valves 	<ul style="list-style-type: none"> • Clean and lubricate valve per diverter valve maintenance instructions
After filling or refilling the spa: a jet pump is operating, but water is not flowing from any of its jets.	<ul style="list-style-type: none"> • Pump is not properly primed. 	<ul style="list-style-type: none"> • Turn off power to the spa at the breaker and remove the equipment compartment door (see the "Draining Your Spa" section for illustration). • Loosen the union on the top of the pump(s) (see the "Winterizing Your Spa" section for illustration) to allow the air to escape, and then hand-tighten the union(s). • Turn power back on, activate the pump, and check to make sure the union is tight enough to keep it from leaking. Replace the equipment doors.

DOOR PANEL INSTRUCTIONS

DOOR PANEL REMOVAL

The illustrations are to be used as a reference only (your spa may look slightly different).

1

Locate and remove the two screws on the bottom of each corner on the front panel (same side as the Control Panel)

2

Locate notch below panel on one side and center. Placing fingers inside notches, pull panel slightly away from spa only on side (not center).

Locate notch on other side of panel and place fingers inside the notch and center notch. Pull panel away from spa, lower panel and store in a cool and shaded place.

NOTE: It may be possible when pulling out the first clip to pull the panel out too far releasing the second clip.

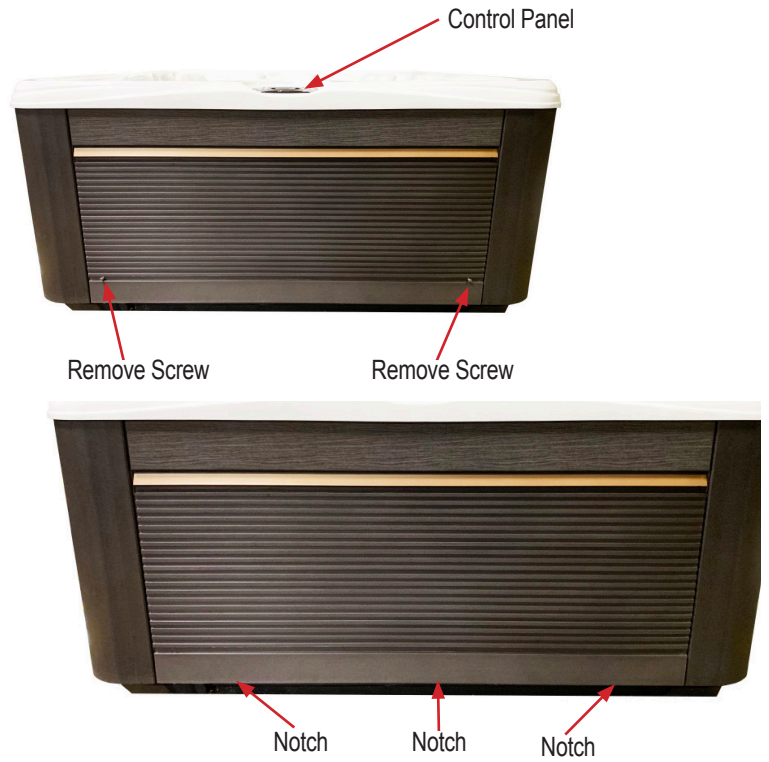

DOOR PANEL REPLACEMENT

1

In order to replace the panel, the illustration to the right shows how the panel is held in place.

- a. The 4 plastic clips attached to the top back side of the door panel slide behind the 4 plastic clips attached to the spa.
- b. The 2 metal clips on the bottom of the door snap into the 2 metal clips attached to the bottom of the spa.

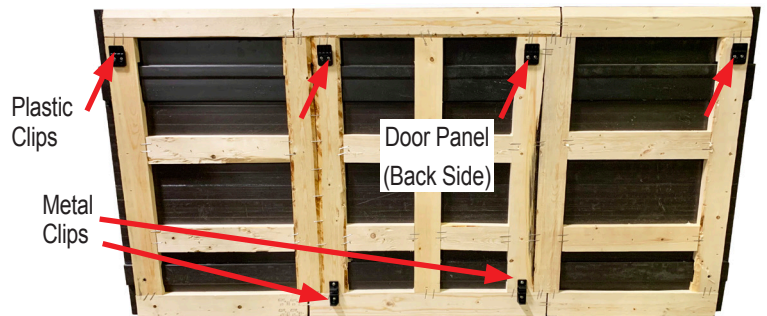
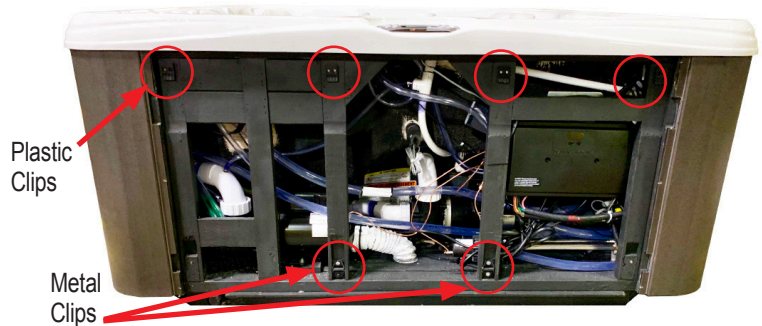

2

Place door panel in position as illustrated to the left.

- a. Raise door panel from bottom making sure all 4 door panel plastic clips are behind the 4 spa plastic clips, this requires the door panel to be behind the bar top.
- b. Using both hands, push in the area where the metal clips are located to snap the door panel metal clips into position.
- c. Replace the 2 screws that were removed in step 1 of the Door Panel Removal section.



PARADISE SPECIFICATIONS

This manual contains installation, operating, maintenance, and service information for the following CALDERA spa

	Footprint Dimensions	Height	Effective Filter Area	Heater (Watts)	Water Capacity	Dry Weight	Filled Weight*	Dead Weight	Electrical Requirements
MAKENA (Model MAAE) Seats 6 Adults	2.3 m x 2.3 m 7'5" x 7'5"	91 cm 36"	7 m ²	3,000	1,500 liters 395 gallons	465 kg 1,020 kg	2,445 kg 5,365 lbs	580 kg/m ² 120 lbs/ft ²	220-240 volt, 16 & 25 amp Single phase RCD protected circuit
SALINA (Model SAAE) Seats 7 Adults	2.3 m x 2.3 cm 7'5" x 7'5"	91 cm 36"	7 m ²	3,000	1,600 liters 420 gallons	455 kg 1,005 lbs	2,615 kg 5,735 lbs	620 kg/m ² 130 lbs/ft ²	220-240 volt, 16 & 25 amp Single phase RCD protected circuit
MARTINIQUE (Model MRAE) Seats 5 Adults	2.3 m x 1.9 m 7'5" x 6'4"	87 cm 34"	5 m ²	3,000	1,080 liters 285 gallons	420 kg 930 lbs	1,895 kg 4,180 lbs	540 kg/m ² 110 lbs/ft ²	220-240 volt, 16 & 25 amp Single phase RCD protected circuit
SEYCHELLES (Model SEYE) Seats 6 Adults	2.1 m x 2.1 m 7'0" x 7'0"	91 cm 36"	7 m ²	3,000	1,250 liters 330 gallons	430 kg 945 lbs	2,160 kg 4,745 lbs	580 kg/m ² 120 lbs/ft ²	220-240 volt, 16 & 25 amp Single phase RCD protected circuit
REUNION (Model RUNE) Seats 7 Adults	2.1 m x 2.1 m 7'0" x 7'0"	91 cm 36"	7 m ²	3,000	1,325 liters 350 gallons	425 kg 940 lbs	2,310 kg 5,085 lbs	620 kg/m ² 130 lbs/ft ²	220-240 volt, 16 & 25 amp Single phase RCD protected circuit
KAUAI (Model KAA) Seats 3 Adults	2.1 m x 1.7 m 7'0" x 5'5"	75 cm 29.5"	5 m ²	3,000	875 liters 230 gallons	335 kg 740 lbs	1,450 kg 3,185 lbs	510 kg/m ² 105 lbs/ft ²	220-240 volt, 16 amp Single phase RCD protected circuit

Watkins Wellness suggests a structural engineer or contractor be consulted before the spa is placed on an elevated deck.

* The "Filled weight" and "Dead weight" of the spa includes the weight of the occupants (assuming an average occupant weight of 80 kg [175 lbs.]).

The RCD (Residual Current Device) may also be referred to as an ELCB (Earth Leakage Circuit Breaker).

©2025 Watkins Wellness. Caldera Spas is a trademark of Watkins Wellness, registered in the U.S., Canada, CTM and other countries.



Watkins Wellness[®]

Feel good. Live well.

Vista, California
USA

calderaspas.com



304137.26

304137.26 A (09/25)