

Certikin
international ltd

SKIMMERS

FEATURES

- Universal skimmer for both concrete and liner pools
- Wide angled and parallel throats
- One piece moulding
- Through the wall installations eliminating exposure and corrosion of pool panels
- Outlet connections in imperial and metric
- Overflow and water fill outlets provided
- Extending collar and square lid for ease of installation
- The new extension throats allow the skimmer body to be positioned any distance from the pool wall. i.e. when using an automatic pool cover



Certikin's range of top quality swimming pool equipment is designed for all types of swimming pools. This leaflet shows just one of the many product ranges available from your Certikin pool equipment supplier. By using only Certikin equipment you will ensure ease of supply now and in the future.

SURFACE WATER SKIMMER

HD100N (concrete/flap)

HD100SN (concrete/collar)

HD100LAK (liner adaptor kit)

The Certikin skimmer is available for concrete and liner pools with either flap or floating collar weir. Designed to remove floating debris from the water surface quietly and efficiently. The liner adaptor kit enables the concrete skimmer to be instantly transformed into liner.

Extension Throat (used in conjunction with HD100N or HD100SN).

HD101CS (concrete wide angle)

Incorporates a front bezel eliminating the need for expensive finishing work and provides an effective "funnel" through to the skimmer.

HD101LS (liner wide angle)

Designed for installation in prefabricated, block and liner, or GRP Pools. Supplied complete with all necessary gaskets and screws.

HD102LN (liner parallel)

Designed for installation in prefabricated, block and liner, or GRP Pools. The Certikin parallel extension throat incorporates the revolutionary front adaptor kit aiding installation. Due to the throat design, extension throats can be fitted together to help create a long channel for those difficult jobs.

HD105 Conversion kit

For easy conversion from flap weir to collar weir skimmer, the HD105 includes a basket, floating collar and guide.

HD103 Kornea Vacuum plate

Allows use of vacuum cleaners in pools where no vacuum point is available. HD103 fits into the skimmer and large debris is collected in the skimmer basket. The clear kornea allows the operator to view the collecting debris.

PP1TH Hose to wall connector

A handy fitting for connecting floating vacuum hose either to a Certikin HD/CK20 vacuum point or an HD103.

HD108 Automatic top up valve

This very efficient and simple to install pool water controller is designed to ensure constant pool water level.

PG3324 Stop plug

1½" BSP plastic stop plug for blanking off outlets not required on skimmer (not illustrated).

HD8M

50mm slip plug for blanking off outlets not required on skimmer (not illustrated).



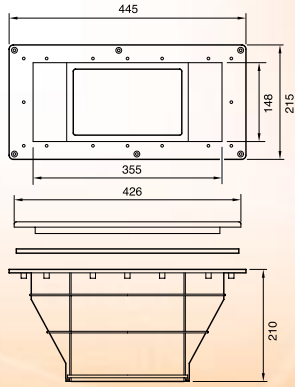

HD101CS Conc.
HD101LS Liner

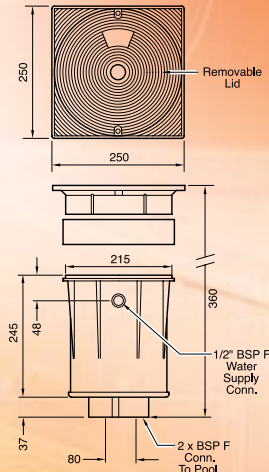

HD108
Water Level Controller
Comes Complete with
Float Operated Valve.

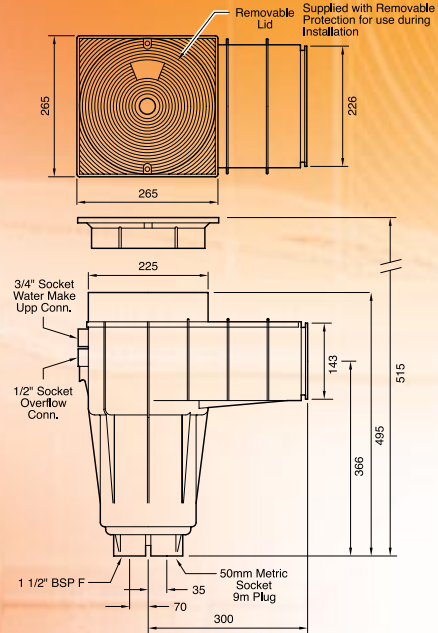

HD100NS (conc/collar)
HD100N (conc/flap)
HD100LAK (Liner adapt. kit)

Has Adjustable Flow Restrictor
for Bottom Connection.
Either Flap Weir-
or Collar Weir.

Front
Finishing
Plate
Pt No 419N

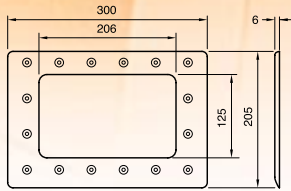

Pt No 420N

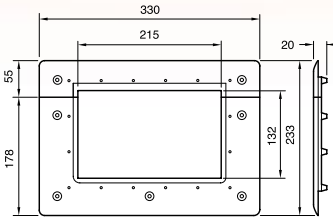

Liner
Plate
Adaptor

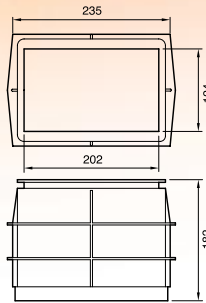

Parallel
Extension
Throat

Clamp
Plate
Pt No 418N

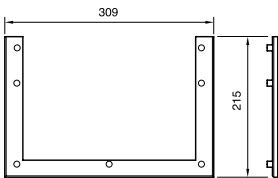

Complete with
Gasket
Self Tapping
Screws
Screw Covers

HD102LN

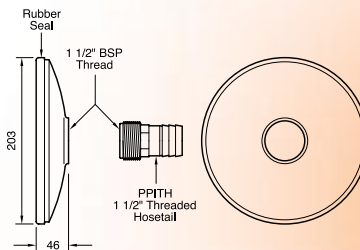

HD103
Accessory to Skimmer
for Vacuuming Pool

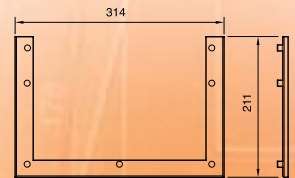
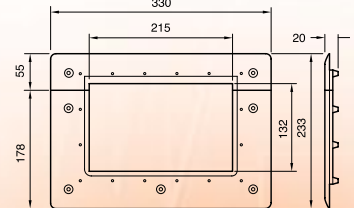
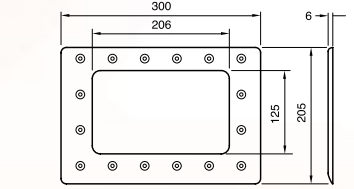

HD100LAK

- Skimmer maximum flow is 4.5m³ per hour

If you should require further technical information
please do not hesitate to contact us.

