

Massivsauna

ALASKA

CORNER

206 x 206 x 204 cm

MONTAGEANLEITUNG
Deutsch

DE

EN

FR

IT

PL

PT



Inhaltsverzeichnis

1. Montage Vorbereitung	3
1.1. Benötigtes Werkzeug	4
1.2. Wartung und Reinigung	5
1.3. Entsorgung	5
1.4. Stückliste ALASKA CORNER	6
2. Montage der Kabine	8
2.1. Montage des Bodenrahmens	8
2.2. Montage der Wandelemente	9
2.3. Montage Dach	17
2.4. Montage Lüftungsschieber	19
2.5. Montage Inneneinrichtung	19
2.6. Montage Zubehör	26
2.7. Montage Glastür	28
2.8. Montage Dachkranz	30
2.9. Montage Dachabdeckleiste	31
3. Grundriss	32
3.1. Grundriss „links“	32
3.2. Grundriss „rechts“	33
3.3. Änderungen bei Montage Grundriss „rechts“	34

1. Montage Vorbereitung

Lesen Sie diese Montageanleitung gut durch und bewahren Sie sie in der Nähe der Sauna auf. So können Sie jederzeit Produktinformationen nachlesen.



Sie finden diese Montageanleitung auch im Downloadbereich unserer Webseite auf www.sentiotec.com/downloads.

Wichtige Hinweise:

- Kontrollieren Sie, bevor Sie mit der Arbeit beginnen, anhand der Stückliste, ob alle Einzelteile auch tatsächlich mitgeliefert wurden. Sollten Einzelteile ausnahmsweise fehlen, benachrichtigen Sie spätestens 14 Tage nach Erhalt der Kabine Ihren Händler.
- Der Raum, in dem die Saunakabine montiert wird, muss trocken sein und eine entsprechende Luftzirkulation gewährleisten.
- Der Fußboden muss waagrecht und eben sein, bevorzugt Stein- oder Fliesenboden.
- Für die Montagearbeiten der Kabine wird eine Mindestraumhöhe von 230 cm benötigt.
- Es muss ein Wandabstand von mindestens 5 cm eingehalten werden.
- Die Innen zu verwendenden Holzteile dürfen nicht mit Imprägniermittel behandelt werden.
- Für die Montage benötigen Sie einen Helfer.
- Holz ist ein Naturprodukt, das trotz guter Lagerung aufquellen, schwinden oder sich verziehen kann. Aus diesem Grund kann es vorkommen, dass bei der Montage etwas Kraft aufgebracht werden muss.
- Alle Verschraubungen müssen vorgebohrt werden.

Achtung!

Der Elektroanschluss darf nur durch eine Elektrofachkraft oder eine vergleichsweise qualifizierte Person ausgeführt werden.

1.1. Benötigtes Werkzeug

- Hammer und Beilageholz oder einen Gummihammer
- Akkuschauber mit Bits für Kreuzschrauben und Torx
- Rollmaßband
- Bohrer mit Durchmesser 3 mm, 10 mm, 20 - 30 mm (für Stromkabel Saunaofen)
- Wasserwaage
- Innensechskant-Schlüssel 1,5 mm
- Universalmesser
- Leiter
- Feinsäge



Dieses Symbol kennzeichnet Tipps und nützliche Hinweise



Vorbohren



Ablängen auf Naturmaß mit Feinsäge



Überprüfung des rechten Winkel:

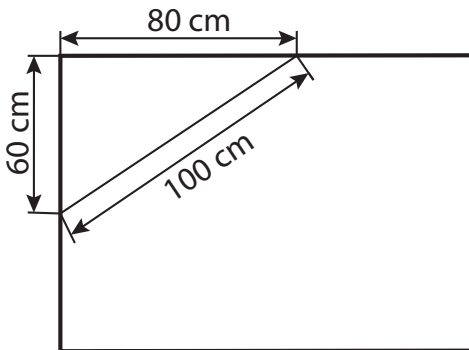

1.2. Wartung und Reinigung

- Die Sauna sollte mit einem feuchten Tuch gereinigt werden. Verwenden Sie nur warmes Wasser - keine Reinigungsmittel.
- Wird die Sauna längere Zeit nicht benutzt, empfehlen wir, die Kabine einmal im Monat aufzuheizen.



Harzgallen sind kein Reklamationsgrund. Da in Fichtenholz immer wieder Harzgallen vorkommen und man beim Aussortieren nicht erkennen kann in welcher Tiefe diese sich befinden.

Wenn diese knapp unter der Oberfläche sind brechen sie bei Hitzeentwicklung auf und „bluten“ aus.

Das ausgelaufene Harz kann man mit einem Aceton gedrängtem Lappen entfernen. Wenn lediglich Harztropfen entstehen, lassen Sie diese aushärten und schaben sie anschließend mit einem Messer vorsichtig ab.

DE

1.3. Entsorgung



- Entsorgen Sie die Verpackungsmaterialien nach den gültigen Entsorgungsrichtlinien.
- Altgeräte enthalten wiederverwendbare Materialien, aber auch schädliche Stoffe. Geben Sie Ihr Altgerät deshalb auf keinen Fall in den Restmüll, sondern entsorgen Sie das Gerät nach den örtlich geltenden Vorschriften.

1.4. Stückliste ALASKA CORNER

Az	Bezeichnung	Maß
Bodenrahmen		
2	Bodenrahmen	204 x 9 x 4 cm
1	Bodenrahmen	138 x 9 x 4 cm
1	Bodenrahmen	61,2 x 9 x 4 cm
Wandelemente		
4	Wandelemente A/B	193 x 48 x 4 cm
3	Wandelemente A/B mit Multiclip	193 x 48 x 4 cm
1	Elektroelement A/A mit Multiclip	193 x 44 x 4 cm
1	Lüftungselement A/B mit Multiclip	193 x 48 x 4 cm
1	Wandelement A/A mit Multiclip	193 x 44 x 4 cm
1	Wandelement A/A	193 x 44 x 4 cm
1	Wandelement A/A mit Multiclip	193 x 55,2 x 4 cm
1	Element oberhalb Tür	69,3 x 10,1 x 4 cm
1	Element oberhalb Glaselement	72,3 x 8,6 x 4 cm
Dachelemente		
2	Dachelemente A/B	194 x 48 x 4 cm
1	Dachelement A/B	194 x 49 x 4 cm
1	Dachelement A/A schräg	186 x 49 x 4 cm
Ecksteher		
3	Ecksteher 90° mit Multiclip	193 x 6 x 6 cm
1	Ecksteher 45° neben Tür mit Multiclip	202 x 7,8 x 4 cm
1	Ecksteher 45° neben Tür mit Nut	202 x 7,8 x 4 cm
1	Steher für Glaselement 8 mm Nut mit Multiclip	202 x 4,5 x 4 cm
Auflageleisten		
1	Dachauflageleiste	197 x 4 x 4 cm
1	Dachauflageleiste	193 x 4 x 4 cm
2	Dachauflageleisten 1 x 45°	141,6 x 4 x 4 cm
1	Dachauflageleiste 2 x 45°	89,7 x 4 x 4 cm
1	Dachabdeckleiste	196 x 1,2 x 4 cm
1	Dachabdeckleiste	192 x 1,2 x 4 cm
2	Dachabdeckleisten 1 x 22,5°	141,2 x 1,2 x 4 cm
1	Dachabdeckleiste 1 x 22,5°	83,2 x 1,2 x 4 cm
1	Bankauflageleiste 1 x 45°	142,3 x 4 x 4 cm
1	Bankauflageleiste	120 x 4 x 4 cm
3	Bankauflageleisten	58 x 4 x 4 cm
2	Montageleisten für Banksichtblende	26 x 4 x 4 cm

Az	Bezeichnung	Maß
Inneneinrichtung		
2	Bänke	195 x 62 x 9 cm
1	Bank	133,5 x 62 x 9 cm
1	Bankabdeckleiste	72,3 x 14 x 2 cm
2	Rückenlehnen	186 x 26 x 5 cm
1	Banksichtblende	195 x 35 x 5 cm
1	Ofenschutzgitter 3-tlg. 1 x 57 x 75 cm, 2x 45,5 x 55 cm	57 x 475 x 75cm
1	Bodenrost	70 x 53 x 4 cm
2	Kopfstützen	43 x 25 x 7 cm
1	Lampenschutzgitter	38 x 32 x 4 cm
1	Lüftungsschieber	52 x 14 x 1,5 cm
Glaselemente		
1	Glastür	191,5 x 68 x 0,8 cm
1	Glaselement	194,5 x 75,5 x 0,8 cm
Dachkranzleisten		
2	Dachkranzleisten 1 x 22,5°	149,8 x 6 x 4 cm
1	Dachkranzleiste 1 x 22,5°	86,5 x 6 x 4 cm
Zubehör		
1	U Alu Profil	72,3 x 1,2 x 1,5 cm
1	Türgriff Set Holz/Niro	
1	2 Türbänder 8653-02	
1	Türmagnet, Überschublech	
1	Saunaleuchte	
1	3 Lfm. Silikonkabel 5 x 2,5mm ²	
1	3 Lfm. Silikonkabel 3 x 1,5mm ²	
1	Schablone für Multiclip Montage	
1	Montagematerialset	
1	Montageanleitung	

2. Montage der Kabine

Die Kabine kann „links“ oder „rechts“ aufgebaut werden, beachten Sie dazu die Grundrisspläne auf Seite 32 und Seite 33.

2.1. Montage des Bodenrahmens

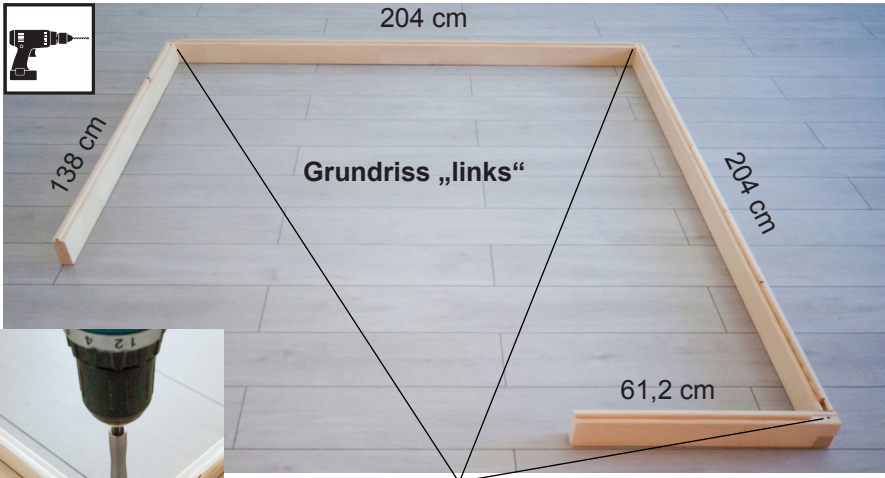

Bohrer 3mm, 3 Stk. Schrauben 4 x 70 mm

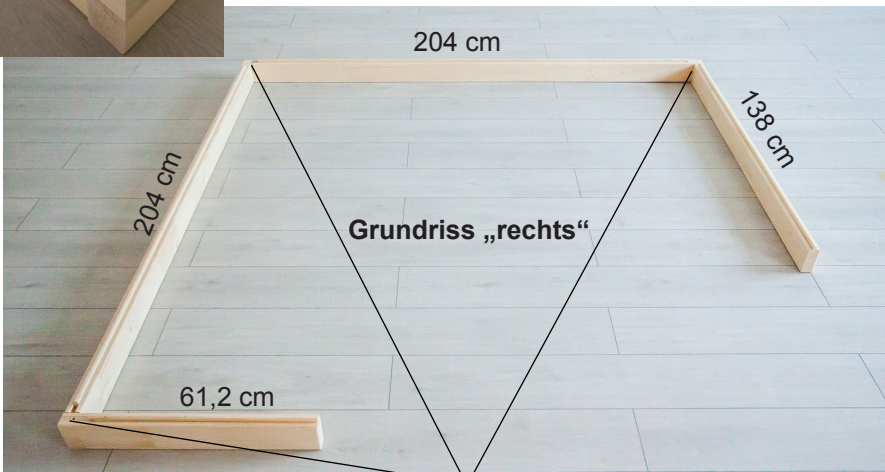
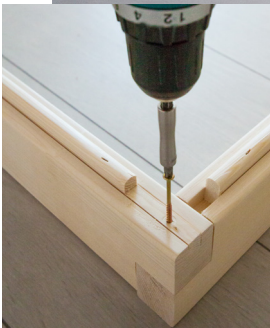

Bohrer 3mm, 3 Stk. Schrauben 4 x 70 mm

2.2. Montage der Wandelemente

Die Ecksteher werden mittels „Multiclips“ mit den Wandelementen verbunden. Die weiteren Wandelemente sind mit Nut und Feder verbunden und werden miteinander verschraubt.



A bezeichnet immer die Sichtseite, dies ist auf der Oberseite der Wandelemente gekennzeichnet.

Achtung!

In weiterer Folge wird die Montage für Grundriss „links“ beschrieben. Änderungen betreffend Montage für Grundriss „rechts“ - siehe Seite 33.

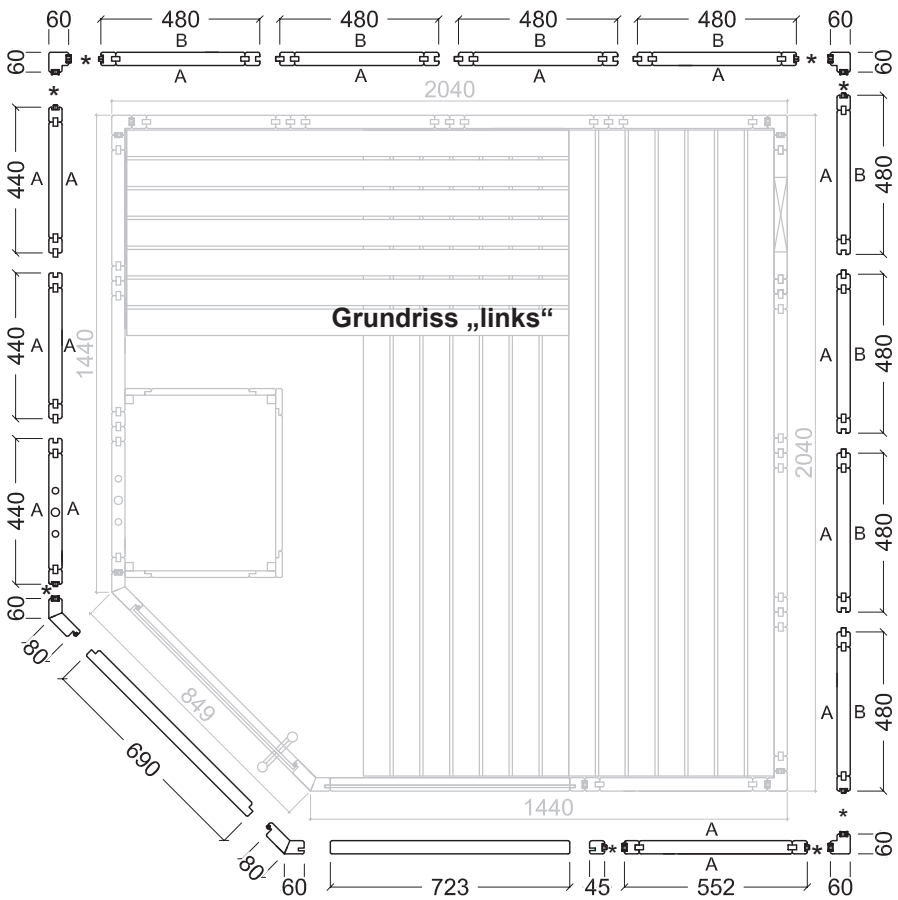

* Multiclips

Montage Ecksteher mit Wandelement



Montieren Sie die Wandelemente mit den Ecksteher am Boden vor und setzen Sie diese Ecken dann auf den Bodenrahmen auf.

Stecken Sie den Ecksteher von oben nach unten auf die Wandelemente. Achten Sie dabei auf die korrekte Ausrichtung der „Multiclips“ (siehe unten). Der Ecksteher muss bündig mit den Wandelementen sein.

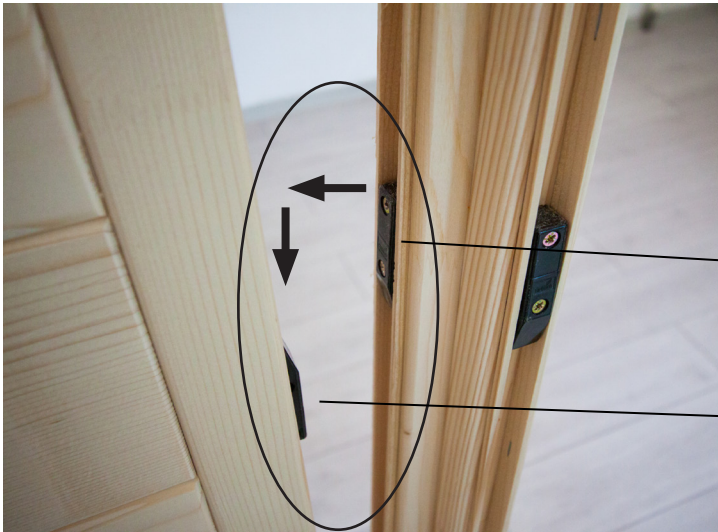

Multiclip



Montage Wandelemente



Das Elektroelement hat Bohrungen zum Verlegen der Kabel. Position siehe Grundrisspläne auf Seite 32 und Seite 33.



DE



Elektroelement

Verschrauben der Wandelemente

Überprüfen Sie die rechten Winkel, bevor Sie die Wandelemente verschrauben. Beachten Sie den Tipp auf Seite 4.



Bohrer 3 mm, 8 Stk. Schrauben 4 x 70 mm

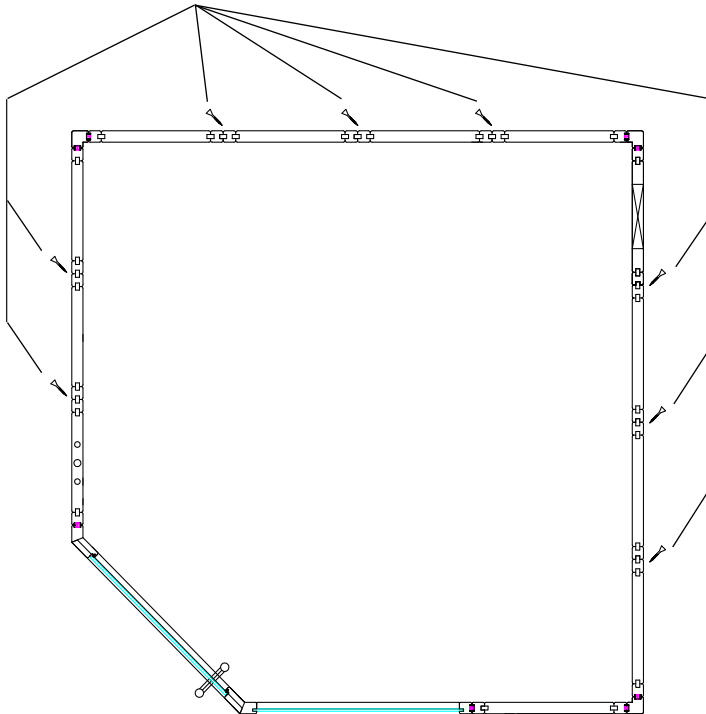

Ecksteher und Steher für Glas



Glaselement

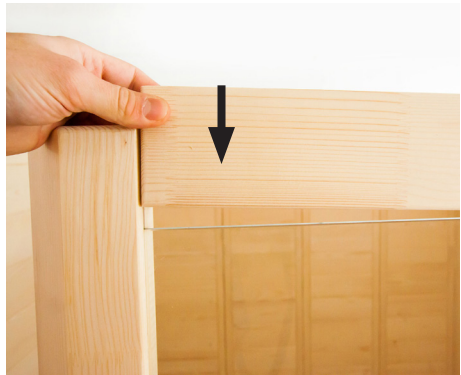

Bohrer 3 mm,
1 Stk. Schrauben 4 x 70 mm

Bohrer 3 mm,
1 Stk. Schrauben 4 x 70 mm

Element oberhalb der Tür

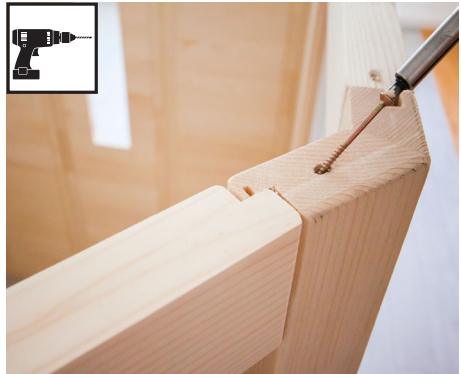

DE

Bohrer 3 mm,
1 Stk. Schrauben 4 x 70 mm



Bohrer 3 mm,
1 Stk. Schrauben 4 x 70 mm

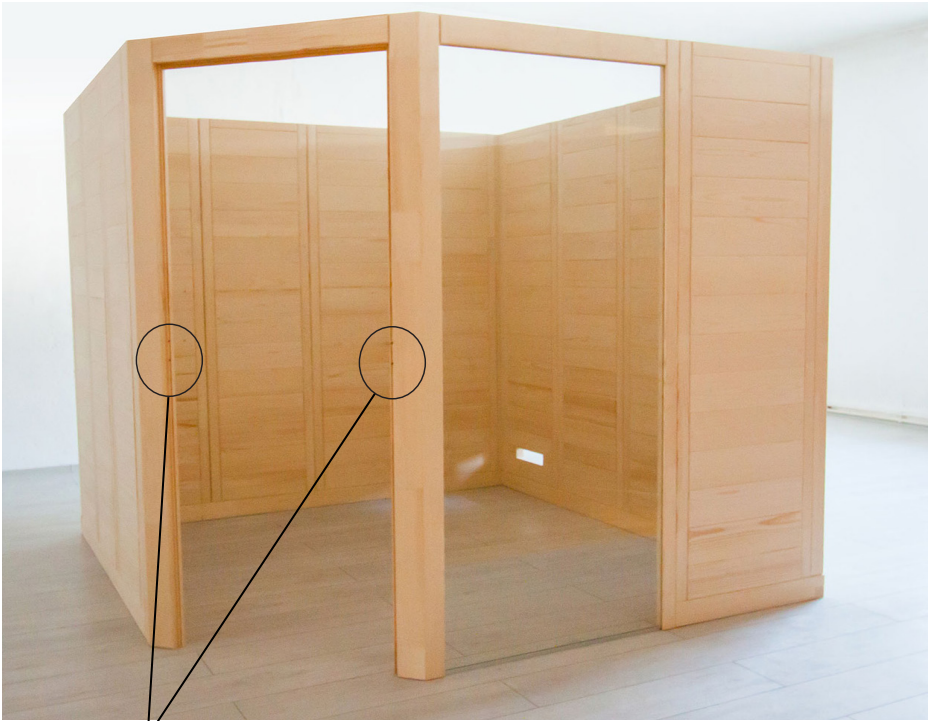

2.3. Montage Dach Dachauflageleisten



Schrauben 4 x 70 mm



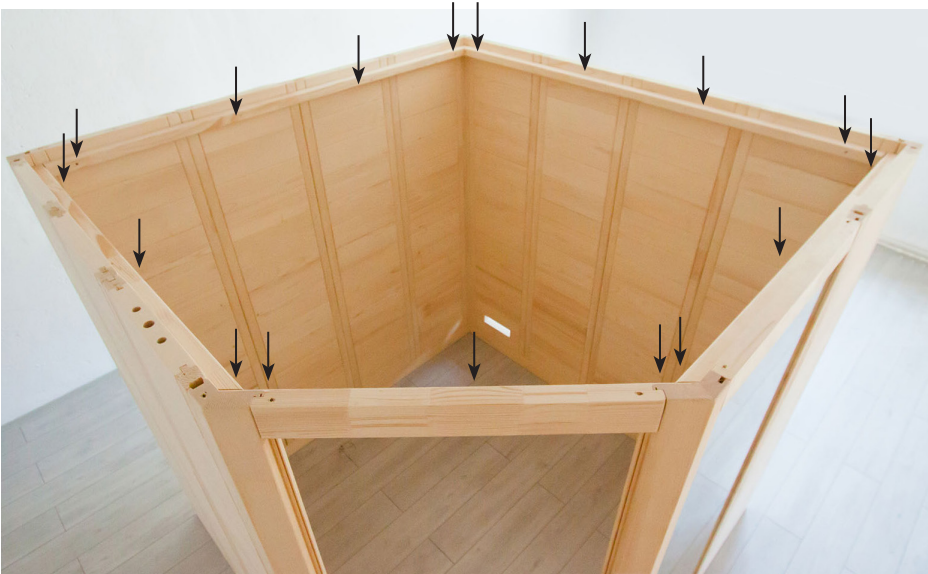

17 Stk. Schrauben 4 x 70 mm

Dachelemente

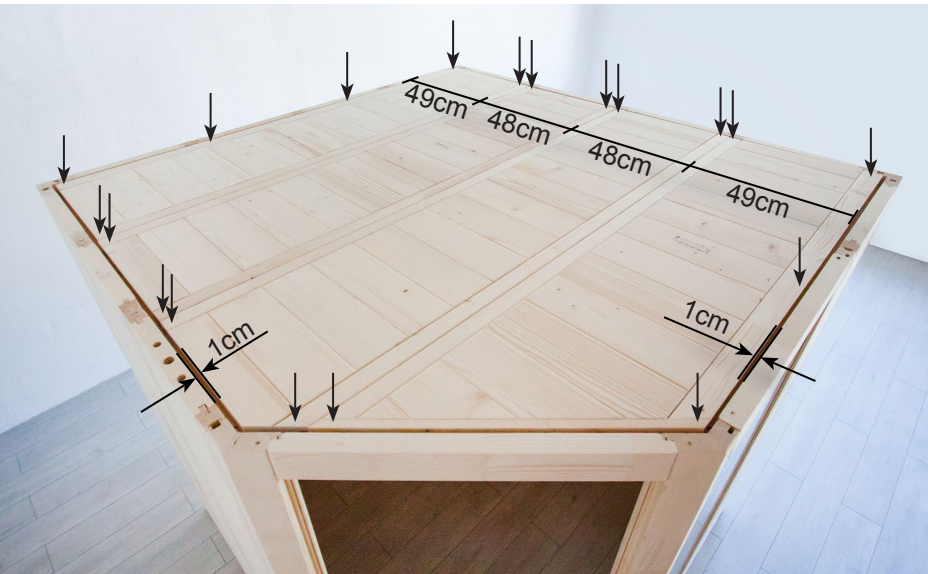

Bohrer 3 mm, 19 Stk. Schrauben 4 x 70 mm

2.4. Montage Lüftungsschieber



DE

Bohrer 3 mm, 4 Stk. Schrauben 3 x 40 mm

2.5. Montage Inneneinrichtung

Bankauflageleisten

Bohrer 3 mm, 3 Stk. Schrauben 5 x 70 mm



2 Stk. Schrauben 4 x 60 mm

Bohrer 3 mm, 3 Stk. Schrauben 5 x 70 mm



Bohrer 3 mm, 3 Stk. Schrauben 5 x 70 mm



Bankauflageleiste mit Abdeckblende vor dem Glasteil



2 Stk. Schrauben 4 x 60 mm



3 Stk. Schrauben 5 x 70 mm



3 Stk. Schrauben 5 x 70 mm
2 Stk. Schrauben 4 x 60 mm



DE

Banksichtblende



4 Stk. Schrauben 4 x 60 mm

Bank

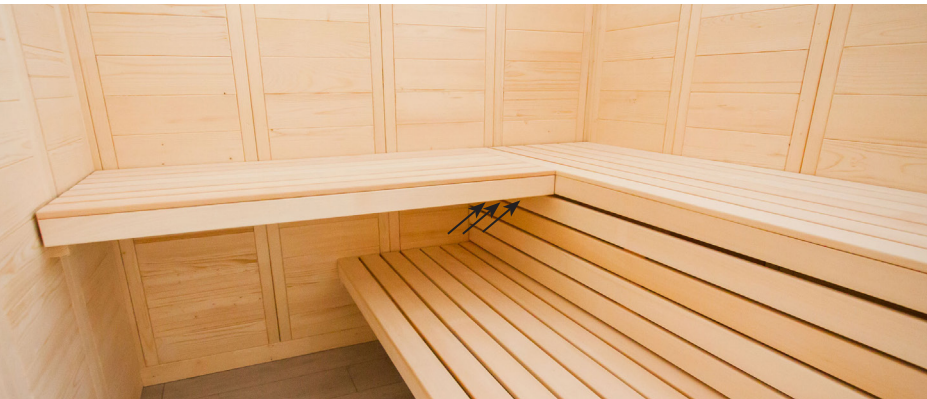

Bohrer 3 mm, 3 Stk. Schrauben 5 x 70 mm



Rückenlehne



Bohrer 3 mm, 6 Stk. Schrauben 3 x 40 mm

DE



2.6. Montage Zubehör

Saunaleuchte



Leuchtmittel einsetzen
(nicht im Lieferumfang enthalten)



Bohrer 3 mm, 2 Stk. Schrauben

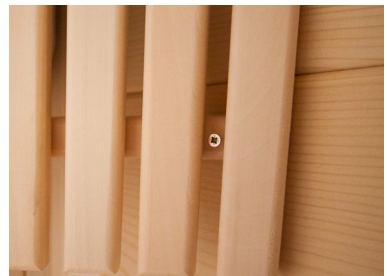

4 Stk. Schrauben 3 x 40 mm

Ofenschutzgitter



Bohren Sie vor der Montage des Ofenschutzgitters den Auslass für das Ofenkabel im Elektroelement.



4 Stk. Schrauben 3 x 40 mm

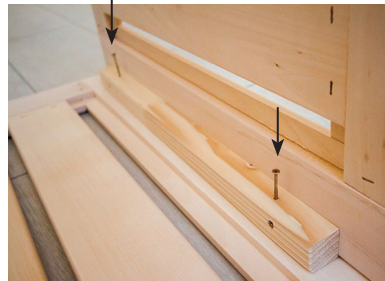

DE



4 Stk. Schrauben 3 x 40 mm



2.7. Montage Glastür



Die untere Bohrung des Türgriffs ist in 92,4 cm Höhe.
Die Ausrichtung der Beschläge wird durch die Justierung / Drehung
der beiden Kunststoffeinlagen vorgenommen.

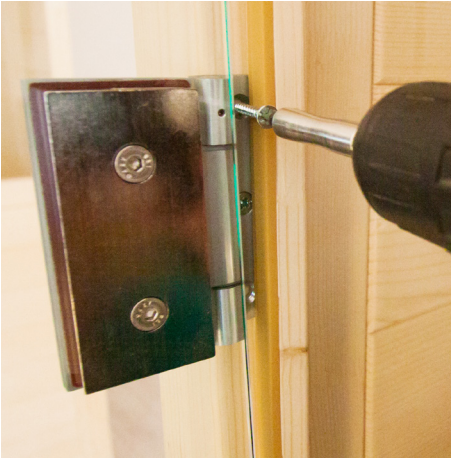
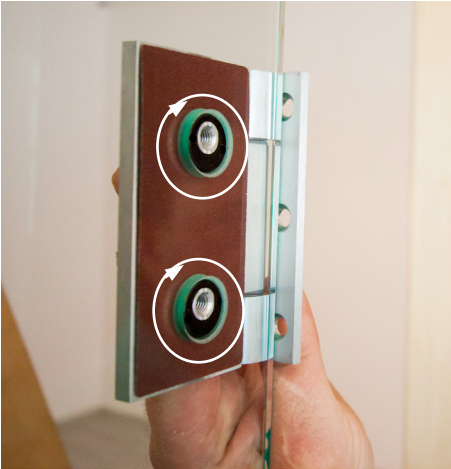

Türgriff und Überschubblech

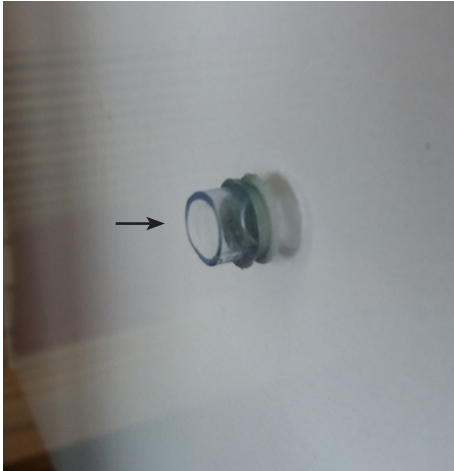

Silikonring in Bohrungen einlegen



Kunststoff Beilagscheibe bei Niro-Griff beilegen



2.8. Montage Dachkranz



Montieren Sie den Dachkranz erst nachdem Sie die Kabel zum Saunaofen und zur Saunasteuerung eingezogen haben. Möglicherweise muss die Leiste beim Elektroelement ausgeschnitten werden.



Bohrer 3 mm, 9 Stk. Schrauben 3 x 40 mm

2.9. Montage Dachabdeckleiste



Montieren Sie die Dachabdeckleiste erst nachdem Sie die Kabel zum Saunaofen und zur Saunasteuerung eingezogen haben. Möglicherweise muss die Leiste beim Elektroelement ausgeschnitten werden.



DE

14 Stk. Schrauben 3 x 40 mm

3. Grundriss

3.1. Grundriss „links“

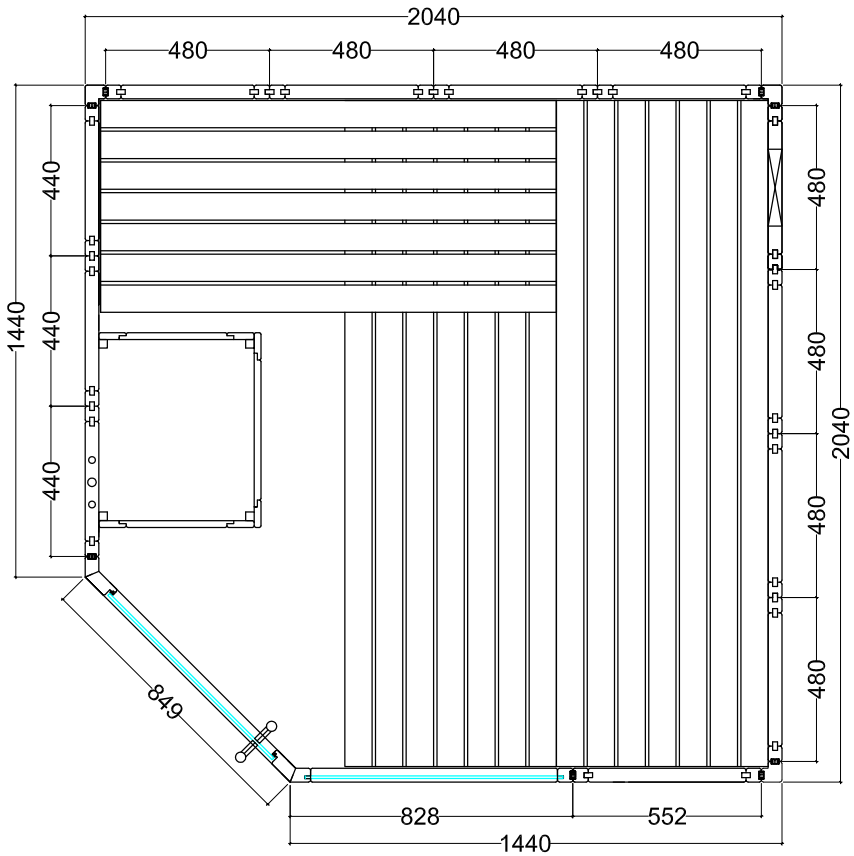

3.2. Grundriss „rechts“

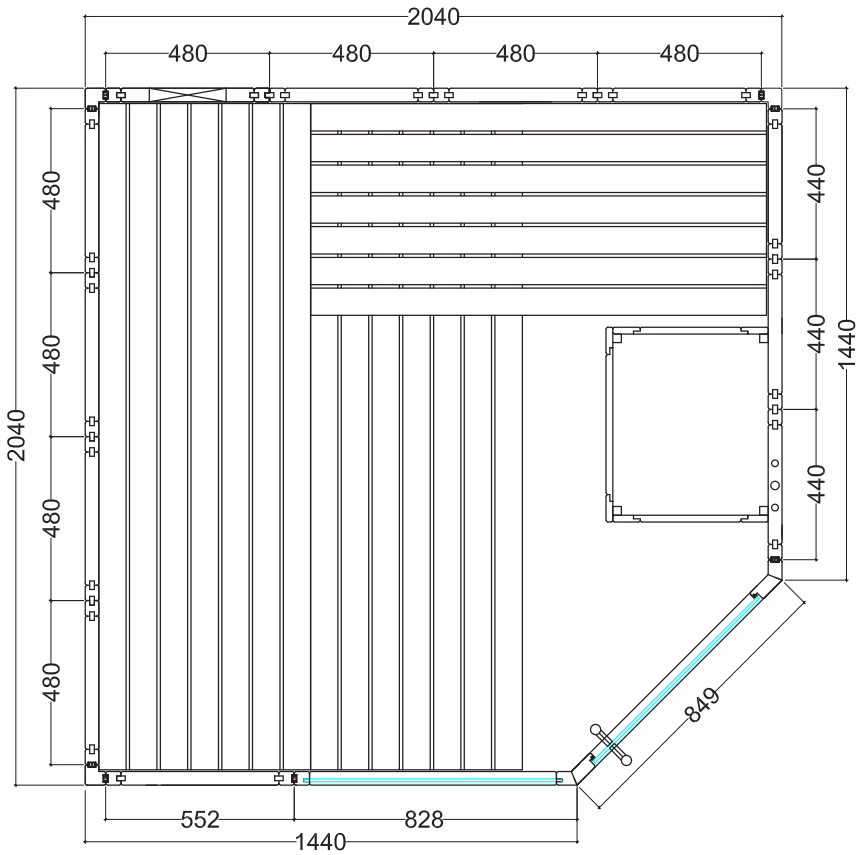

DE

3.3. Änderungen bei Montage Grundriss „rechts“

Für die Montage von Ecksteher und Steher für das Glas (Seite 13)

Entfernen Sie die Multiclips vom Ecksteher und dem Steher für Glas.
Verwenden Sie die beiliegende Schablone für die neue Positionierung der Multiclips.

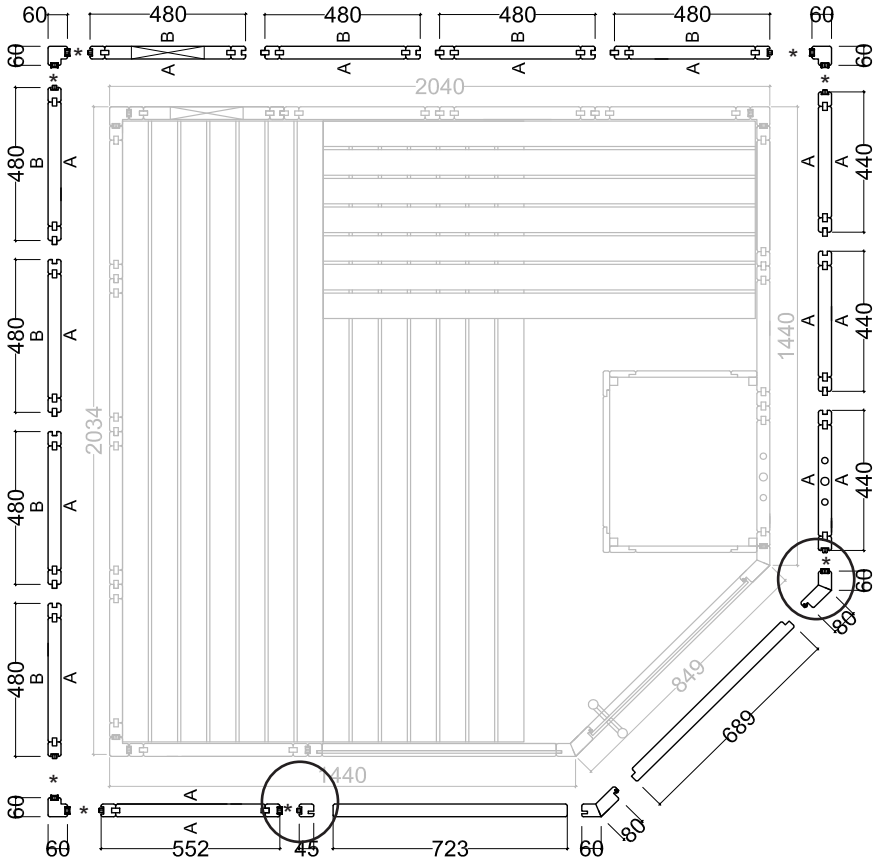

* Multiclips



DE





sentiotec GmbH | Division of Harvia Group | Oberregauer Straße 48, A-4844 Regau
T +43 (0) 7672/277 20-567 | F -801 | info@sentiotec.com | www.sentiotec.com

Solid wood sauna

ALASKA

CORNER

206 x 206 x 204 cm

INSTRUCTIONS FOR INSTALLATION
English

EN



Table of Contents

1. Montage Vorbereitung	3
1.1. Benötigtes Werkzeug	4
1.2. Wartung und Reinigung	5
1.3. Entsorgung	5
1.4. Stückliste ALASKA CORNER	6
2. Montage der Kabine	8
2.1. Montage des Bodenrahmens	8
2.2. Montage der Wandelemente	9
2.3. Montage Dach	17
2.4. Montage Lüftungsschieber	19
2.5. Montage Inneneinrichtung	19
2.6. Montage Zubehör	26
2.7. Montage Glastür	28
2.8. Montage Dachkranz	30
2.9. Montage Dachabdeckleiste	31
3. Grundriss	32
3.1. Grundriss „links“	32
3.2. Grundriss „rechts“	33
3.3. Änderungen bei Montage Grundriss „rechts“	34

1. Preparing for installation

Read these installation instructions carefully and keep them within reach when using the sauna so that you can look up product information at any time.



These installation instructions can also be found in the downloads section of our website: www.sentiotec.com/downloads.

Important note:

- Before you begin work, check the parts list to ensure that all the individual parts have been delivered. If you discover any missing parts, notify your dealer within 14 days of receiving the sauna cabin.
- The room that the sauna is installed in must be dry and ensure an appropriate amount of air circulation.
- The floor must be level and even, preferably a stone or tiled floor.
- A minimum room height of 230 cm is required for the cabin installation work.
- A distance of at least 5 cm from the wall must be maintained.
- The inside of the wooden parts used must not be handled with any impregnating material.
- You need an assistant for the installation.
- Wood is a natural product that can swell, shrink or warp, despite good storage. For this reason, some force may be necessary during the installation.
- All screw fittings must be pre-drilled.

Attention!

The electrical connection may only be performed by a qualified electrician or similarly qualified person.

1.1. Tools required

- Hammer with a wooden head or a mallet
- Cordless screwdriver with bits for cross-head screws and Torx
- Roller tape measure
- Drill bits with a diameter of 3 mm, 10 mm, 20 - 30 mm (for sauna heater power cable)
- Spirit level
- 1.5 mm hexagonal socket wrench
- Utility knife
- Ladder
- Backsaw



This symbol indicates tips and useful information



Pre-drill



Cut to real measurement with backsaw



Check the right angle:

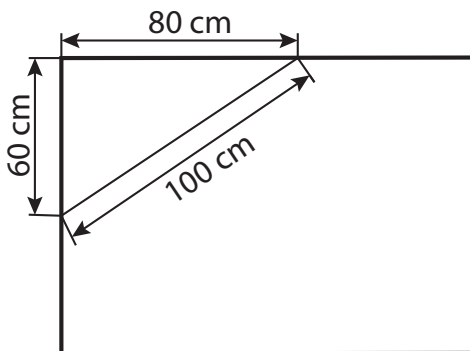

1.2. Maintenance and cleaning

- The sauna should be cleaned with a damp cloth. Only use warm water – no cleaning products.
- We recommend heating the cabin once a month if the sauna is not used for a long time.



Pitch pockets are not grounds for return, since they can always appear in spruce wood and the depth at which they lie cannot be detected during the sorting-out process.

If these are just under the surface, heat can cause them to soften and “bleed”.

The leaking pitch can be removed with a rag soaked in acetone. If only droplets of pitch occur, allow these to harden and then carefully scrape them off with a knife.

EN

1.3. Disposal



- Please dispose of packaging materials in accordance with the applicable disposal regulations.
- Used units contain reusable materials as well as hazardous substances. Therefore, do not dispose of your used unit with household waste, but rather do so in accordance with the locally applicable regulations.

1.4. ALASKA CORNER parts list

No. of items	Name	Dimensions
Base frame		
2	Base frame	204 x 9 x 4 cm
1	Base frame	138 x 9 x 4 cm
1	Base frame	61.2 x 9 x 4 cm
Wall elements		
4	A/B wall elements	193 x 48 x 4 cm
3	A/B wall elements with Multiclip	193 x 48 x 4 cm
1	A/A electrical element with Multiclip	193 x 44 x 4 cm
1	A/B ventilation element with Multiclip	193 x 48 x 4 cm
1	A/A wall element with Multiclip	193 x 44 x 4 cm
1	A/A wall element	193 x 44 x 4 cm
1	A/A wall element with Multiclip	193 x 55.2 x 4 cm
1	Element above the door	69.3 x 10.1 x 4 cm
1	Element above the glass element	72.3 x 8.6 x 4 cm
Ceiling elements		
2	A/B ceiling elements	194 x 48 x 4 cm
1	A/B ceiling element	194 x 49 x 4 cm
1	A/A ceiling element, diagonal	186 x 49 x 4 cm
Corner posts		
3	90° corner posts with Multiclip	193 x 6 x 6 cm
1	45° corner posts next to door with Multiclip	202 x 7.8 x 4 cm
1	45° corner posts next to door with groove	202 x 7.8 x 4 cm
1	Post for glass element, 8 mm groove with Multiclip	202 x 4.5 x 4 cm
Support slats		
1	Roof support slat	197 x 4 x 4 cm
1	Roof support slat	193 x 4 x 4 cm
2	Roof support slat 1 x 45°	141.6 x 4 x 4 cm
1	Roof support slats 2 x 45°	89.7 x 4 x 4 cm
1	Roof support slat	196 x 1.2 x 4 cm
1	Roof support slat	192 x 1.2 x 4 cm
2	Roof support slat 1 x 22.5°	141.2 x 1.2 x 4 cm
1	Roof support slat 1 x 22.5°	83.2 x 1.2 x 4 cm
1	Bench support slat 1 x 45°	142.3 x 4 x 4 cm
1	Bench support slat	120 x 4 x 4 cm
3	Bench support slats	58 x 4 x 4 cm
2	Mounting slats for bench screen	26 x 4 x 4 cm

No. of items	Name	Dimensions
Interior fittings		
2	Benches	195 x 62 x 9 cm
1	Bench	133.5 x 62 x 9 cm
1	Bench cover strip	72.3 x 14 x 2 cm
2	Backrests	186 x 26 x 5 cm
1	Bench screen	195 x 35 x 5 cm
1	Heater safety guard, 3 parts 1 x 57 x 75 cm, 2x 45.5 x 55 cm	57 x 475 x 75 cm
1	Floor grid	70 x 53 x 4 cm
2	Headrests	43 x 25 x 7 cm
1	Lamp protection grille	38 x 32 x 4 cm
1	Ventilation slit	52 x 14 x 1.5 cm
Glass elements		
1	Glass door	191.5 x 68 x 0.8 cm
1	Glass element	194.5 x 75.5 x 0.8 cm
Roof trim slats		
2	Roof trim slat 1 x 22.5°	149.8 x 6 x 4 cm
1	Roof trim slat 1 x 22.5°	86.5 x 6 x 4 cm
Accessories		
1	U aluminium profile	72.3 x 1.2 x 1.5 cm
1	Door handle set wood/stainless steel	
1	2 door hinges 8653-02	
1	Door magnet, sleeve plate	
1	Sauna lamp	
1	3 Silicon cables: 5 x 2.5 mm ²	
1	3 Silicon cables: 3 x 1.5 mm ²	
1	Template for Multiclip installation	
1	Installation material set	
1	Installation instructions	

2. Cabin installation

The cabin can have a right or left set-up; please note the corresponding floor plans on page 32 and page 33.

2.1. Base frame installation

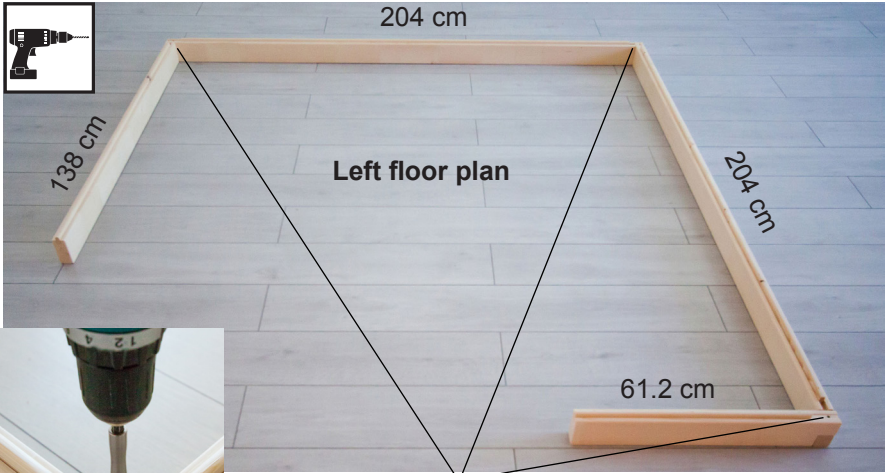

3 mm drill bit, 3 screws 4 x 70 mm

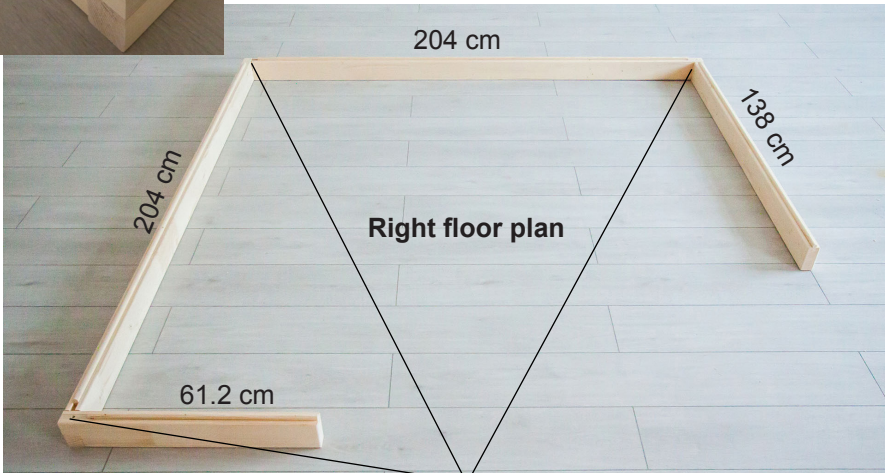
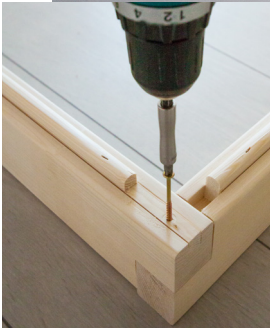

3 mm drill bit, 3 screws 4 x 70 mm

2.2. Wall element assembly

The corner posts are connected to the wall elements using Multiclips. The other wall elements are connected tongue and groove and are screwed together.



A always refers to the visible side. This is labelled on the top side of the wall elements.

Attention!

The installation subsequently described is for the left floor plan. For changes affecting the installation for the right floor plan, see page 33.

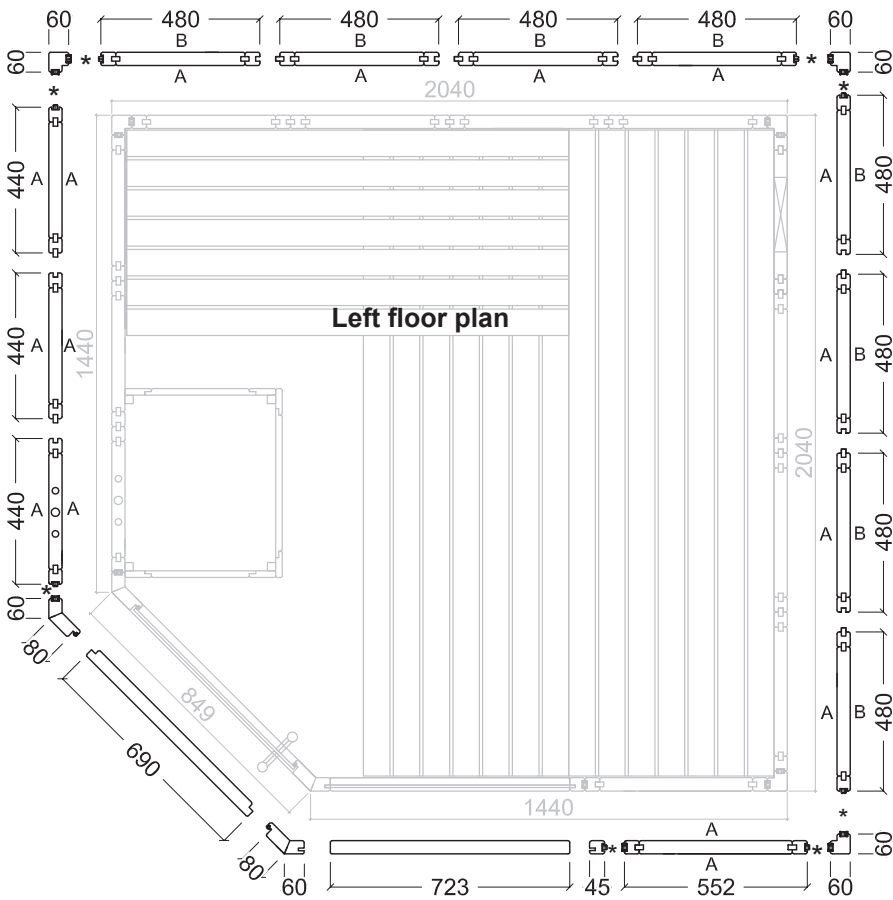

* Multiclips

Installing corner posts with wall elements



Pre-assemble the wall elements with the corner posts on the floor and then place these posts on the base frame.

Insert the corner post from above down onto the wall elements. When doing this, ensure that the Multiclips are correctly aligned (see below). The corner post must be flush with the wall elements.

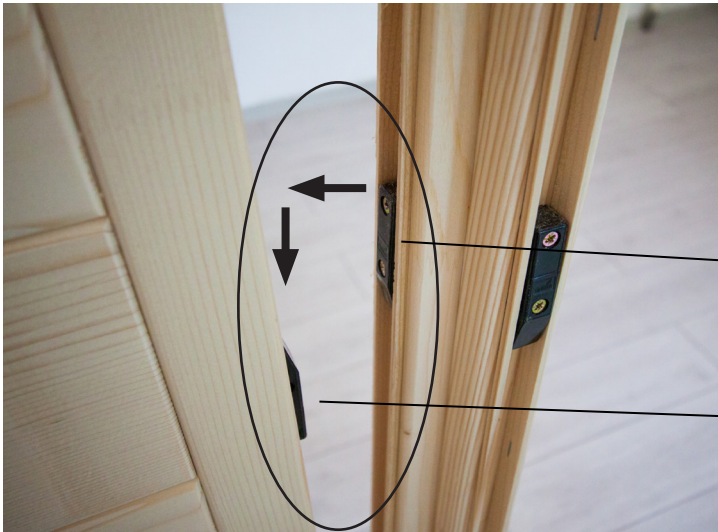

Multiclip



Installing wall elements



The electrical element has drill holes for laying cables. For the position see floor plans on page 32 and page 33.



EN



Electrical element

Screwing wall elements together



Check the right angle before screwing the wall elements together.
Observe the tip on page 4.



3 mm drill bit, 8 screws 4 x 70 mm

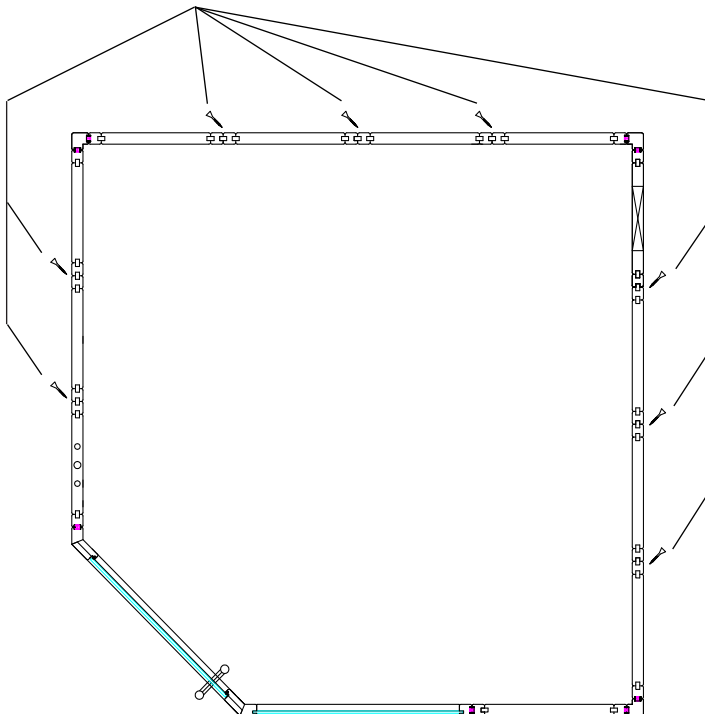

Corner post and post for glass



Glass element

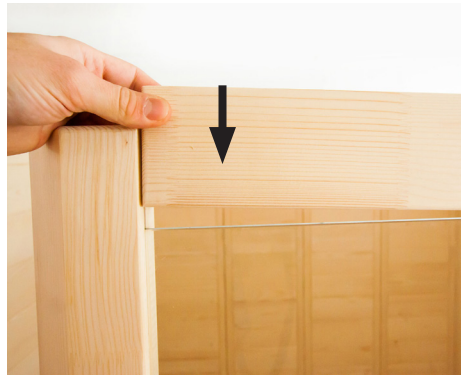

3 mm drill bit,
1 screw 4 x 70 mm



3 mm drill bit,
1 screw 4 x 70 mm

Element above the door



EN

3 mm drill bit,
1 screw 4 x 70 mm



3 mm drill bit,
1 screw 4 x 70 mm



2.3. Ceiling installation

Roof support slats



Screws 4 x 70 mm



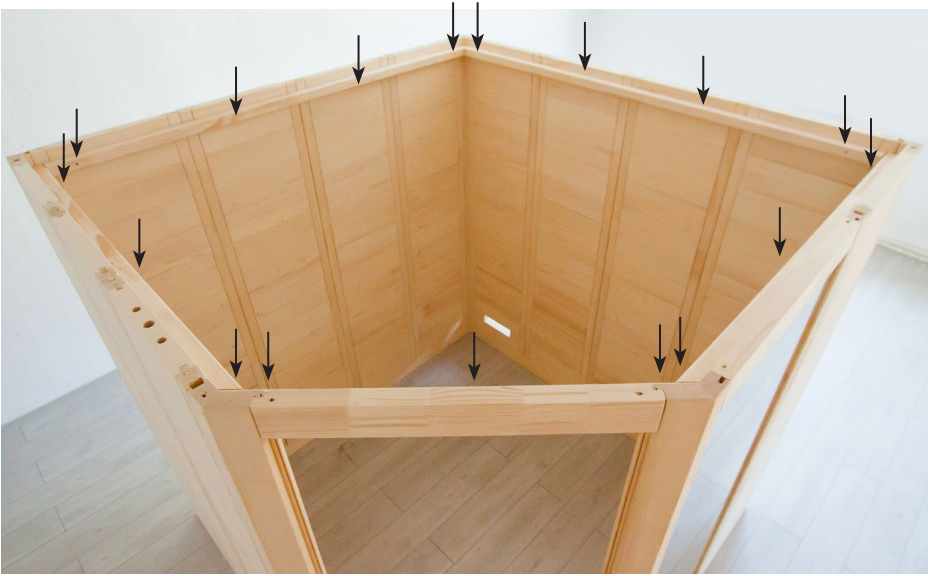

17 screws 4 x 70 mm

Ceiling elements

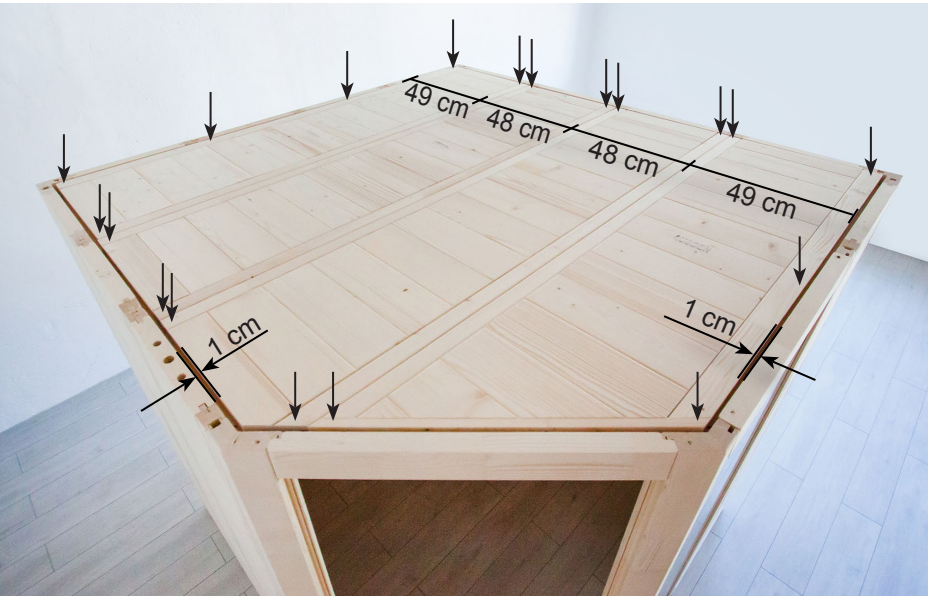

3 mm drill bit, 19 screws 4 x 70 mm

2.4. Ventilation slit installation



3 mm drill bit, 4 screws 3 x 40 mm

2.5. Installing interior fittings

Bench support slats

3 mm drill bit, 3 screws 5 x 70 mm



2 screws 4 x 60 mm

3 mm drill bit, 3 screws 5 x 70 mm

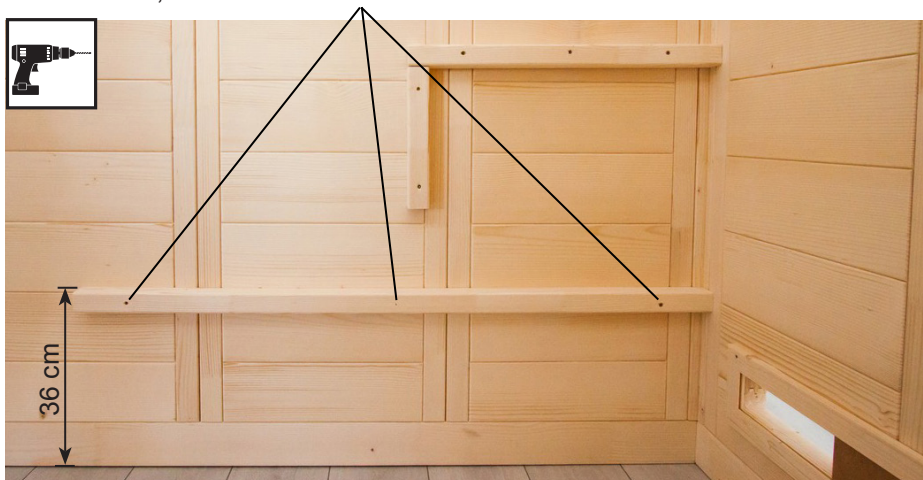

3 mm drill bit, 3 screws 5 x 70 mm

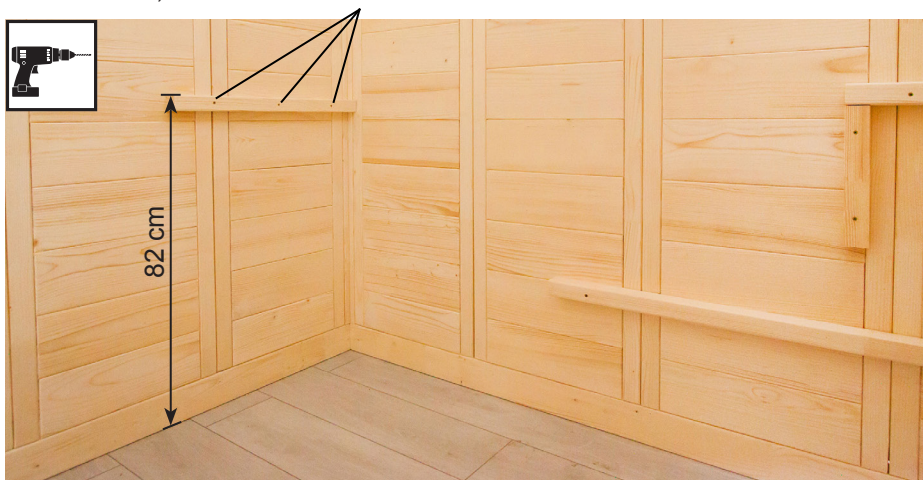

Bench support slat with cover in front of glass element

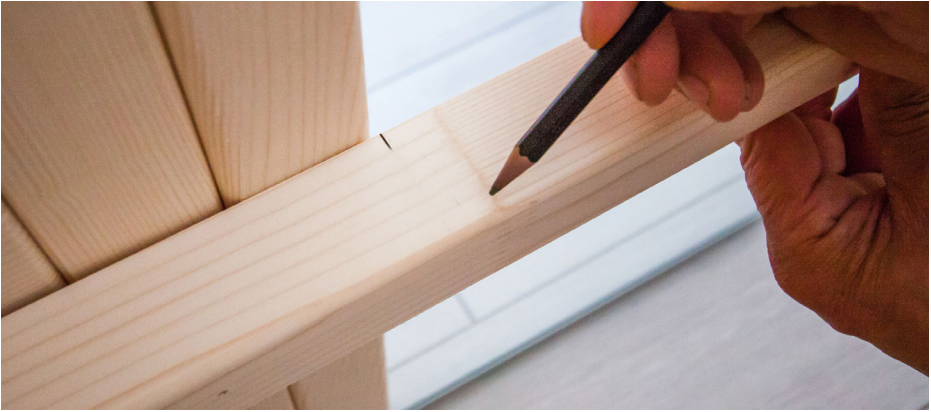

EN



2 screws 4 x 60 mm



3 screws 5 x 70 mm



3 screws 5 x 70 mm
2 screws 4 x 60 mm

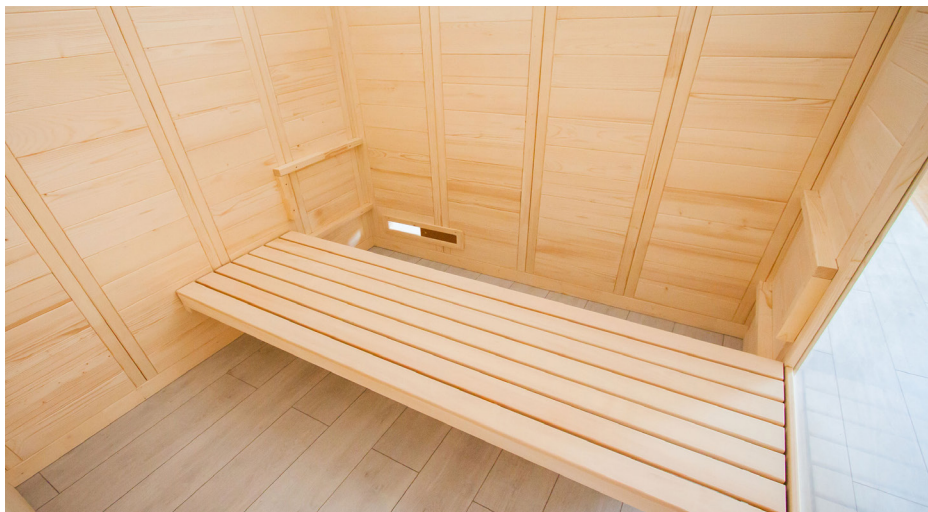

Bench screen

EN

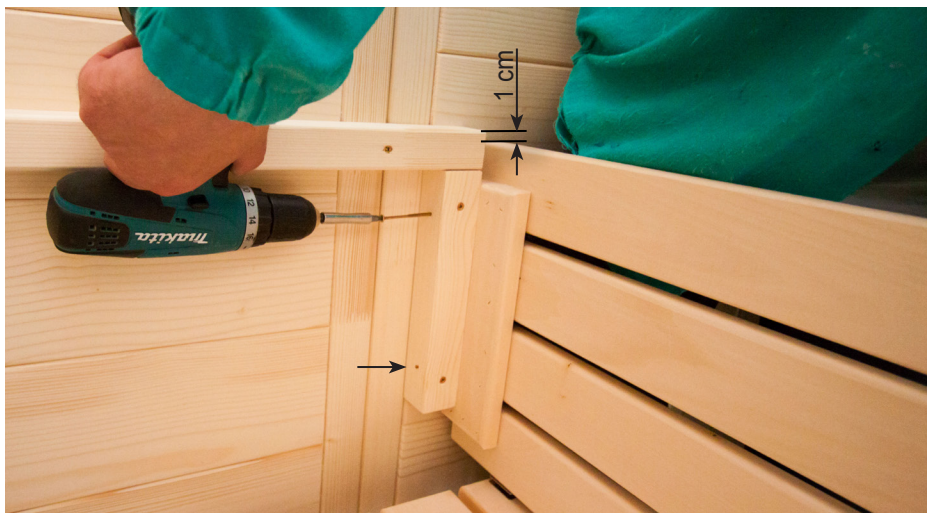

4 screws 4 x 60 mm

Bench

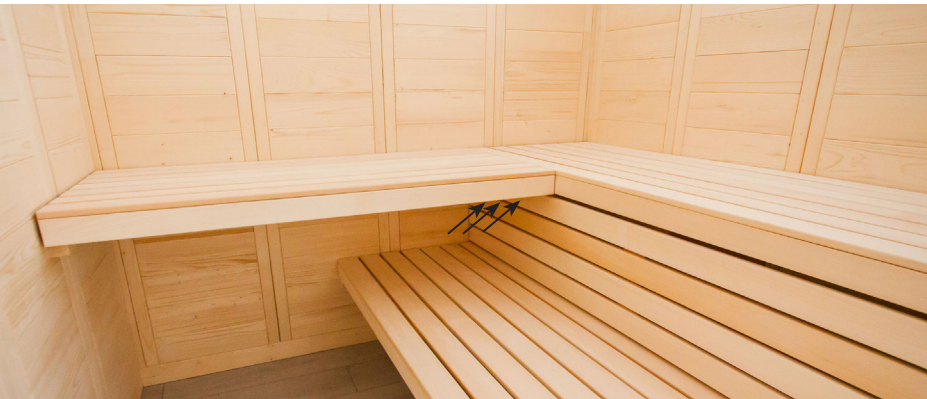

3 mm drill bit, 3 screws 5 x 70 mm

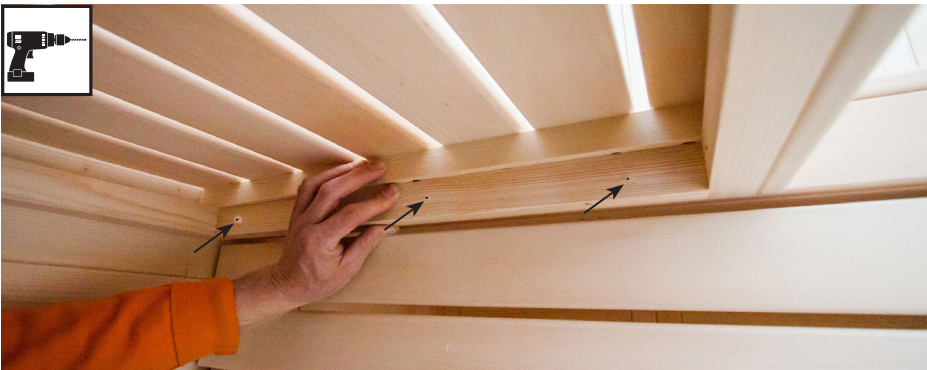

Backrests

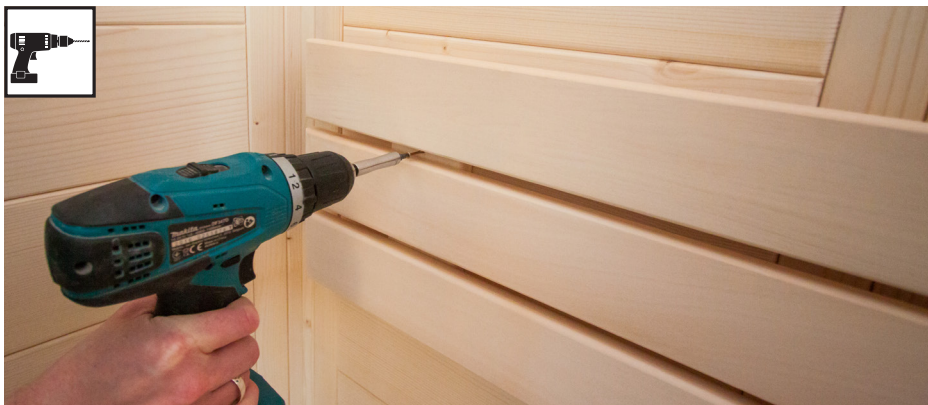

3 mm drill bit, 6 screws 3 x 40 mm



2.6. Installing accessories

Sauna lamp



Insert lamp
(not included in the scope of delivery)



3 mm drill bit, 2 screws

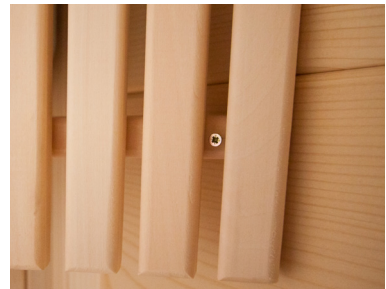

4 screws 3 x 40 mm

Heater protection grille



Before installing the heater protection grille, drill the outlet for the heater cable in the electrical element.



4 screws 3 x 40 mm

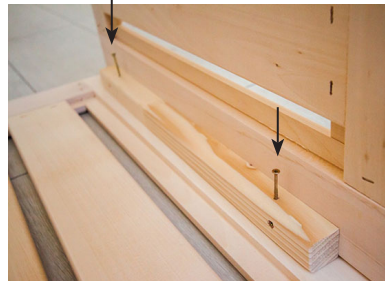

EN



4 screws 3 x 40 mm



2.7. Installing glass door



The bottom drill hole of the door handle is 92.4 cm high.
The alignment of the fittings is achieved by adjusting / rotating both plastic inserts.

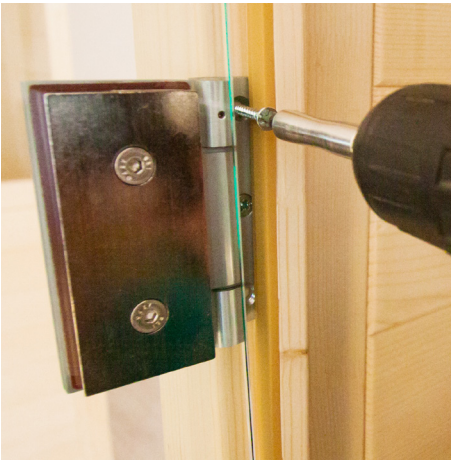
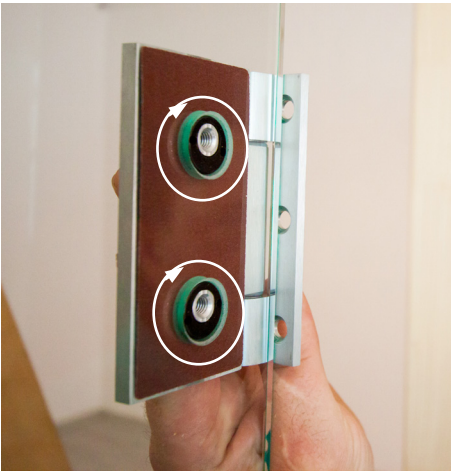

Door handle and sleeve plate

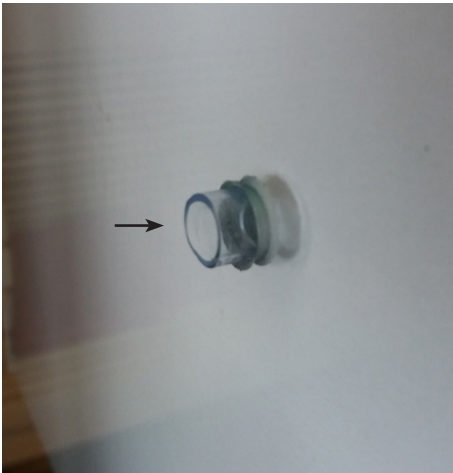

Insert silicone ring in the drill holes



Attach plastic washers on the stainless steel handle



2.8. Installing roof trim



Install the roof trim only after you have inserted the cable to the sauna heater and to the sauna control unit. The slat on the electrical element may possibly have to be cropped.



3 mm drill bit, 9 screws 3 x 40 mm

2.9. Installing ceiling cover slat



Install the ceiling cover slat only after you have inserted the cable to the sauna heater and to the sauna control unit. The slat on the electrical element may possibly have to be cropped.



EN

14 screws 3 x 40 mm

3. Floor plan

3.1. Left floor plan

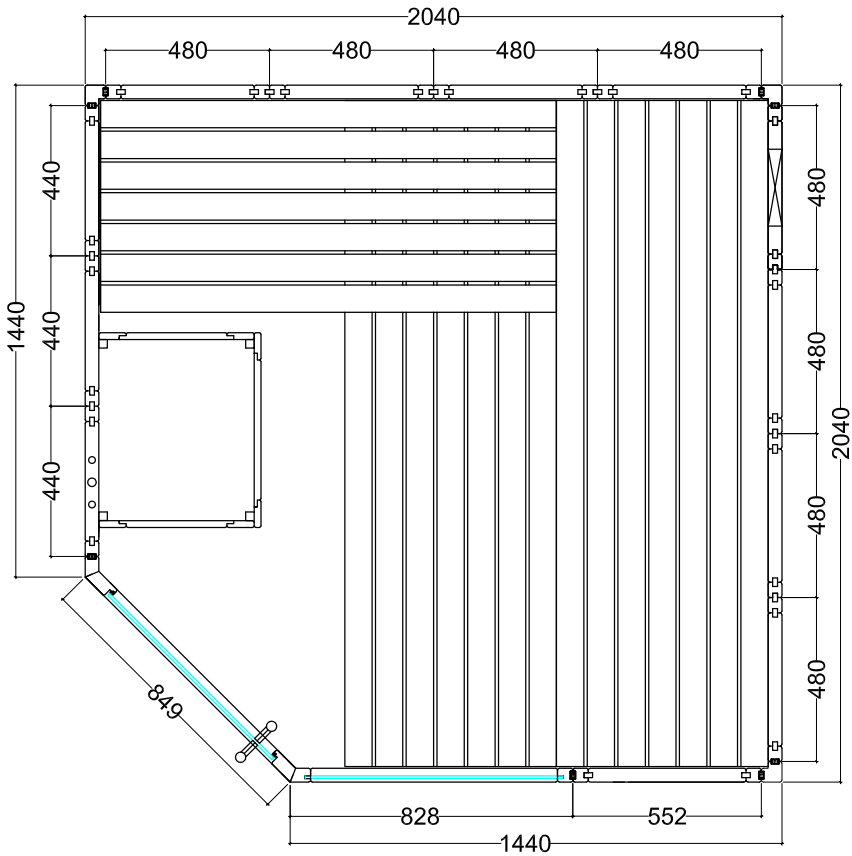

3.2. Right floor plan

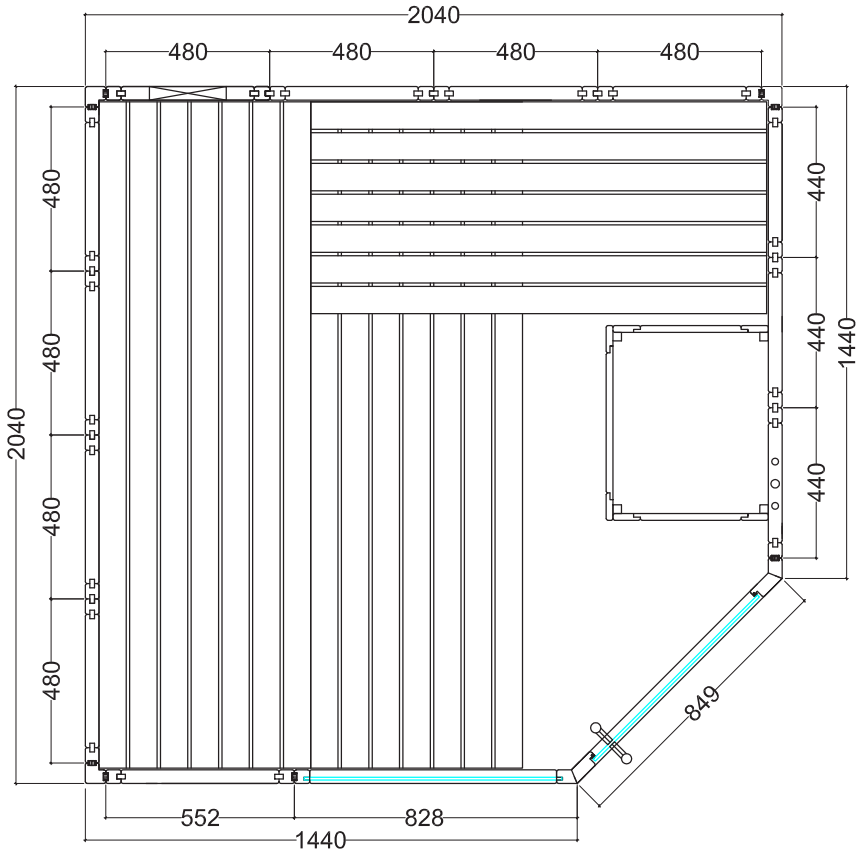

3.3. Changes for the right floor plan installation

For installing corner posts and posts for the glass (page 13)

Remove the Multiclips from the corner posts and the post for the glass.
Use the supplied template for the new positioning of the Multiclips.

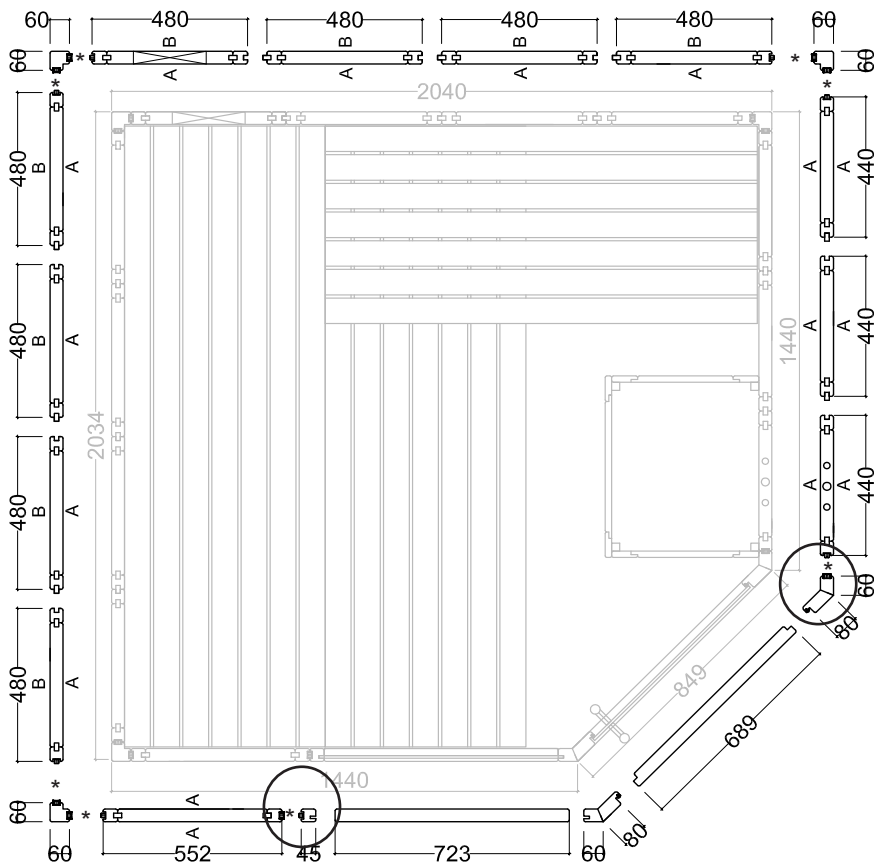

* Multiclips



EN





sentiotec GmbH | Division of Harvia Group | Oberregauer Straße 48, A-4844 Regau
Phone +43 (0) 7672/277 20-567 | Fax -801 | info@sentiotec.com | www.sentiotec.com

Sauna en bois massif

ALASKA

CORNER

206 x 206 x 204 cm

INSTRUCTIONS DE MONTAGE
Français



FR

Table des matières

1. Préparation du montage	3
1.1. Outils requis	4
1.2. Entretien et nettoyage	5
1.3. Élimination	5
1.4. Nomenclature ALASKA CORNER	6
2. Montage de la cabine	8
2.1. Montage du cadre de plancher	8
2.2. Montage des éléments muraux	9
2.3. Montage du toit	17
2.4. Montage du registre d'aération	19
2.5. Montage de l'équipement intérieur	19
2.6. Montage des accessoires	26
2.7. Montage de la porte en verre	28
2.8. Montage de la couronne	30
2.9. Montage de la baguette couvre-joint	31
3. Plan	32
3.1. Plan « à gauche »	32
3.2. Plan « à droite »	33
3.3. Modifications lors du montage selon le plan « à droite »	34

1. Préparation du montage

Lisez attentivement les présentes instructions de montage et gardez-les à proximité de l'appareil. Vous avez ainsi accès à tout moment aux informations sur le produit.



Vous trouverez également ces instructions de montage dans la rubrique de téléchargement de notre site Internet www.sentiotec.com/downloads.

Remarques importantes :

- Avant de commencer les travaux, vérifiez au moyen de la nomenclature si toutes les pièces ont bien été livrées. S'il devait s'avérer que des pièces manquent, informez votre revendeur dans les 14 jours suivant la réception de la cabine.
- La pièce dans laquelle la cabine de sauna va être montée doit être sèche et disposer d'une circulation suffisante de l'air.
- Le sol doit être horizontal et lisse, de préférence en pierre ou carrelage.
- Pour les travaux de montage de la cabine, la pièce doit faire au moins 230 cm de haut.
- Une distance d'au moins 5 cm avec le mur doit être respecté.
- Les pièces en bois prévues pour l'intérieur ne doivent pas être traitées avec un agent d'imprégnation.
- Une deuxième personne doit être disponible pour vous aider.
- Malgré un stockage correct, le bois est un produit naturel qui peut gonfler, se contracter ou se déformer. C'est pourquoi il peut arriver que vous ayez à appliquer de la force lors du montage.
- Tous les raccords vissés doivent être préalésés.

Attention !

Seul un électricien spécialisé ou une personne ayant une qualification similaire est habilité à procéder au raccordement électrique.

1.1. Outils requis

- Marteau et cales ou maillet en caoutchouc
- Visseuse électrique avec bits pour vis en croix et Torx
- Ruban de mesure
- Foret de 3 mm de diamètre, 10 mm, 20 - 30 mm (pour câble électrique poêle de sauna)
- Niveau à bulle
- Clé Allen 1,5 mm
- Couteau universel
- Échelle
- Scie fine



Ce symbole désigne les conseils et indications utiles.



Préalésage



Sciage à la bonne longueur avec une scie fine



Contrôle de l'angle droit :

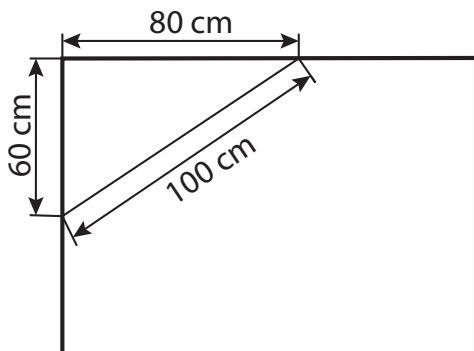

1.2. Entretien et nettoyage

- Le sauna doit être nettoyé au moyen d'un chiffon humide. N'utilisez que de l'eau chaude, pas de détergent.
- Si le sauna n'est pas utilisé pendant une période prolongée, nous recommandons de chauffer la cabine une fois par mois.



Les poches de résines ne constituent pas un motif de réclamation en raison de leur présence régulière dans le bois d'épicéa et de l'impossibilité de déterminer leur profondeur lors de la sélection du bois.

Si elles se trouvent juste sous la surface, elles éclatent et s'écoulent quand elle sont exposées à la chaleur.

Retirez la résine écoulee à l'aide "un chiffon imbibé d'acétone. Si vous constatez uniquement des gouttes de résine, attendez qu'elles aient durci, puis grattez-les avec précaution à l'aide d'un couteau.

1.3. Élimination



- Éliminez les matériaux d'emballage conformément aux directives en vigueur relatives à l'élimination.
- Les appareils usagés contiennent des matériaux recyclables, mais aussi des substances toxiques. Par conséquent, ne jetez en aucun cas votre appareil usagé avec les déchets ménagers. Éliminez-le conformément aux directives locales en vigueur.

1.4. Nomenclature ALASKA CORNER

Az	Désignation	Dimensions
Cadre de plancher		
2	Cadre de plancher	204 x 9 x 4 cm
1	Cadre de plancher	138 x 9 x 4 cm
1	Cadre de plancher	61,2 x 9 x 4 cm
Éléments muraux		
4	Éléments muraux A/B	193 x 48 x 4 cm
3	Éléments muraux A/B avec multclip	193 x 48 x 4 cm
1	Éléments électriques A/A avec multclip	193 x 44 x 4 cm
1	Élément de ventilation A/B avec multclip	193 x 48 x 4 cm
1	Élément mural A/A avec multclip	193 x 44 x 4 cm
1	Élément mural A/A	193 x 44 x 4 cm
1	Élément mural A/A avec multclip	193 x 55,2 x 4 cm
1	Élément au-dessus de la porte	69,3 x 10,1 x 4 cm
1	Élément au-dessus de l'élément en verre	72,3 x 8,6 x 4 cm
Éléments du toit		
2	Éléments de toit A/B	194 x 48 x 4 cm
1	Élément de toit A/B	194 x 49 x 4 cm
1	Élément de toit A/A incliné	186 x 49 x 4 cm
Montant d'angle		
3	Montant d'angle 90° avec multclip	193 x 6 x 6 cm
1	Montant d'angle 45° à côté de porte avec Multclip	202 x 7,8 x 4 cm
1	Montant d'angle 45° à côté de porte avec rainure	202 x 7,8 x 4 cm
1	Montant pour élément en verre rainure 8 mm avec Multclip	202 x 4,5 x 4 cm
Baguettes d'appui		
1	Baguette d'appui de toiture	197 x 4 x 4 cm
1	Baguette d'appui de toiture	193 x 4 x 4 cm
2	Baguettes d'appui de toiture 1 x 45°	141,6 x 4 x 4 cm
1	Baguette d'appui de toiture 2 x 45°	89,7 x 4 x 4 cm
1	Baguette couvre-joint de toiture	196 x 1,2 x 4 cm
1	Baguette couvre-joint de toiture	192 x 1,2 x 4 cm
2	Baguettes d'appui de toiture 1 x 22,5°	141,2 x 1,2 x 4 cm
1	Baguette d'appui de toiture 1 x 22,5°	83,2 x 1,2 x 4 cm
1	Baguette d'appui de banc 1 x 45°	142,3 x 4 x 4 cm
1	Baguette d'appui de banc	120 x 4 x 4 cm
3	Baguettes d'appui de banc	58 x 4 x 4 cm
2	Baguettes de montage pour écran de banc	26 x 4 x 4 cm

Az Désignation	Dimensions
Équipement intérieur	
2 Bancs	195 x 62 x 9 cm
1 Banc	133,5 x 62 x 9 cm
1 Baguette couvre-joint de banc	72,3 x 14 x 2 cm
2 Dossiers	186 x 26 x 5 cm
1 Écran de banc	195 x 35 x 5 cm
1 Grille de protection de poêle en 3 parties 1 x 57 x 75 cm, 2 x 45,5 x 55 cm	57 x 475 x 75 cm
1 Grille de plancher	70 x 53 x 4 cm
2 Appuie-tête	43 x 25 x 7 cm
1 Grille de protection de lampe	38 x 32 x 4 cm
1 Registres d'aération	52 x 14 x 1,5 cm
Éléments en verre	
1 Porte en verre	191,5 x 68 x 0,8 cm
1 Élément en verre	194,5 x 75,5 x 0,8 cm
Baguettes de la couronne	
2 Baguettes de la couronne 1 x 22,5°	149,8 x 6 x 4 cm
1 Baguette de la couronne 1 x 22,5°	86,5 x 6 x 4 cm
Accessoires	
1 Profilé en U alu	72,3 x 1,2 x 1,5 cm
1 Kit poignée bois/inox	
1 2 charnières 8653-02	
1 Aimant de porte, tôle extérieure	
1 Éclairage de sauna	
1 3 mètres linéaires Câble silicone 5 x 2,5 mm ²	
1 3 mètres linéaires Câble silicone 3 x 1,5 mm ²	
1 Gabarit pour montage multiclip	
1 Kit de matériel de montage	
1 Instructions de montage	

2. Montage de la cabine

La cabine peut être montée « à gauche » ou « à droite ». Référez-vous aux plans page 32 et page 33.

2.1. Montage du cadre de plancher

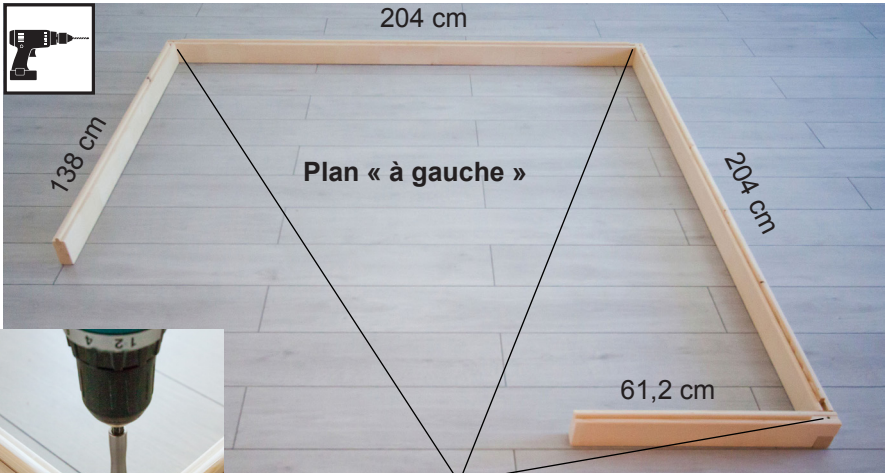

Foret de 3 mm, 3 vis 4 x 70 mm

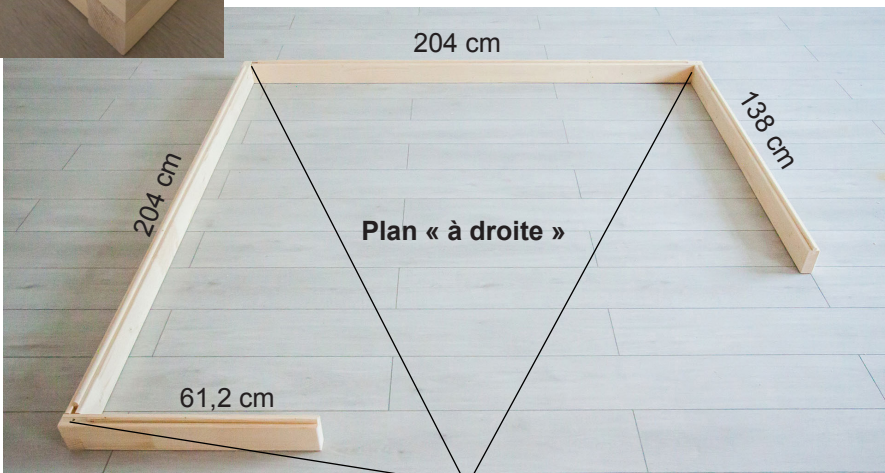

Foret de 3 mm, 3 vis 4 x 70 mm

2.2. Montage des éléments muraux

Fixez les montants d'angle aux éléments muraux au moyen des « multiclips ». Les autres éléments muraux sont reliés par des rainures et des languettes, et sont vissés les uns aux autres.



A désigne toujours le côté apparent qui est indiqué sur la face supérieure des éléments muraux.

Attention !

Ci-après, le montage du plan « à gauche » est décrit. Pour toutes modifications relatives au montage selon le plan « à droite », voir page 33.

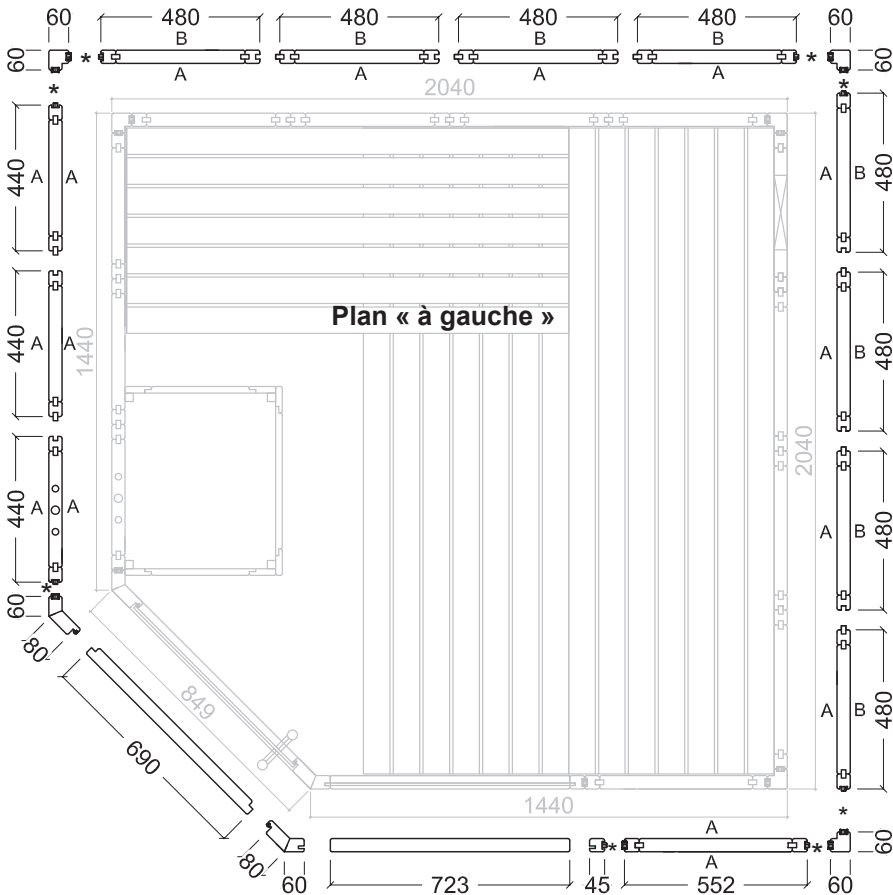

* Multiclips

Montage des montants d'angle sur les éléments muraux

Prémontez les éléments muraux et les montants d'angle au sol, puis placez ces angles sur le cadre de plancher.

Placez le montant d'angle du haut vers le bas sur les éléments muraux. Assurez-vous que l'orientation des « multiclips » est correcte (voir ci-dessous). Le montant d'angle doit être à fleur avec les éléments muraux.

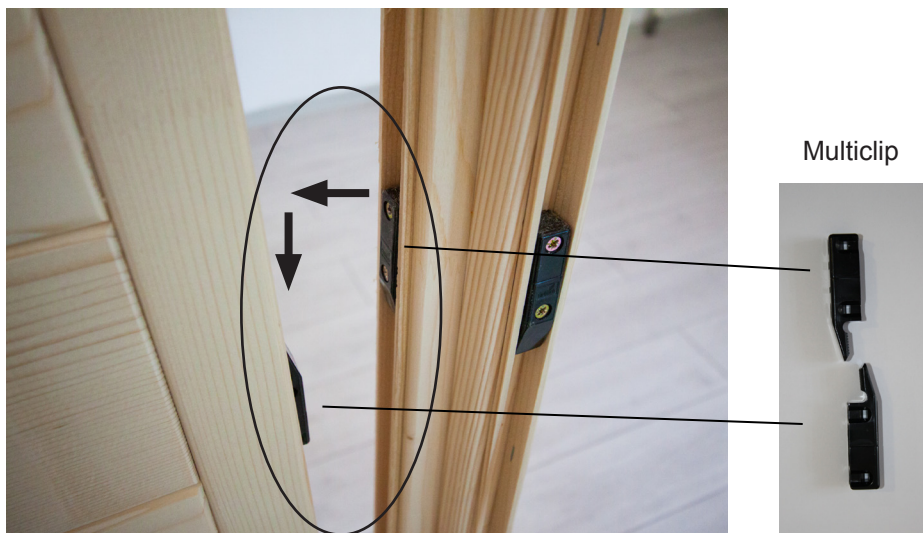

Montage des éléments muraux

Des trous sont prévus sur l'élément électrique afin de poser le câble.
Pour la position, consultez page 32 et page 33.



FR



Élément électrique

Vissage des éléments muraux



Contrôlez les angles droits avant de visser les éléments muraux. Consultez le conseil page 4.



Foret de 3 mm, 8 vis 4 x 70 mm

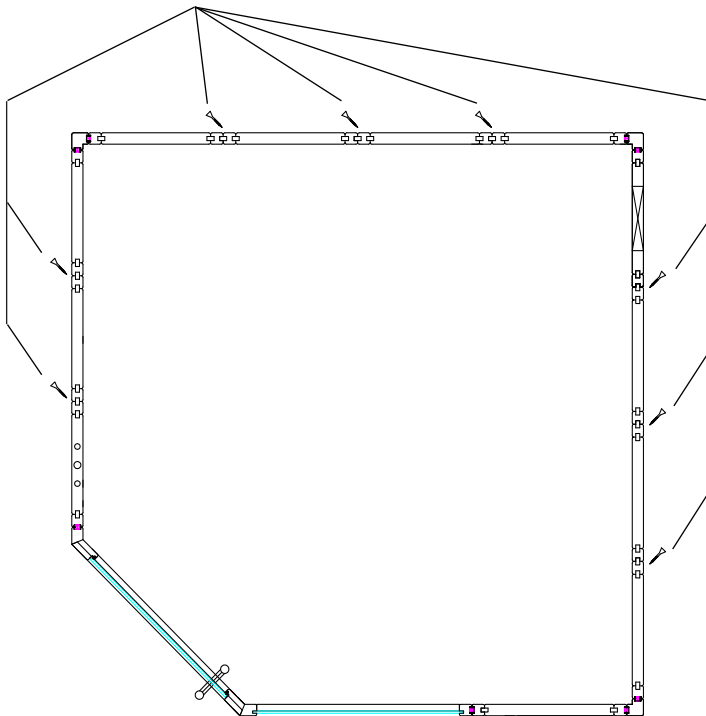

Montant d'angle et montant pour verre



Élément en verre

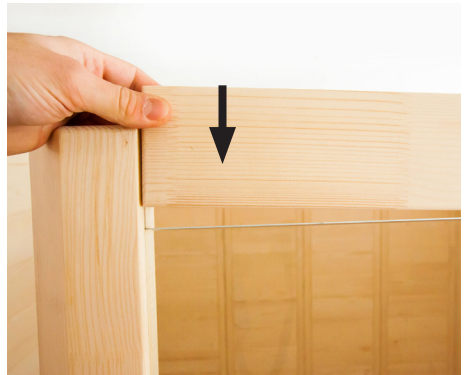

Foret de 3 mm,
1 vis 4 x 70 mm



Foret de 3 mm,
1 vis 4 x 70 mm

Élément au-dessus de la porte



FR

Foret de 3 mm,
1 vis 4 x 70 mm



Foret de 3 mm,
1 vis 4 x 70 mm

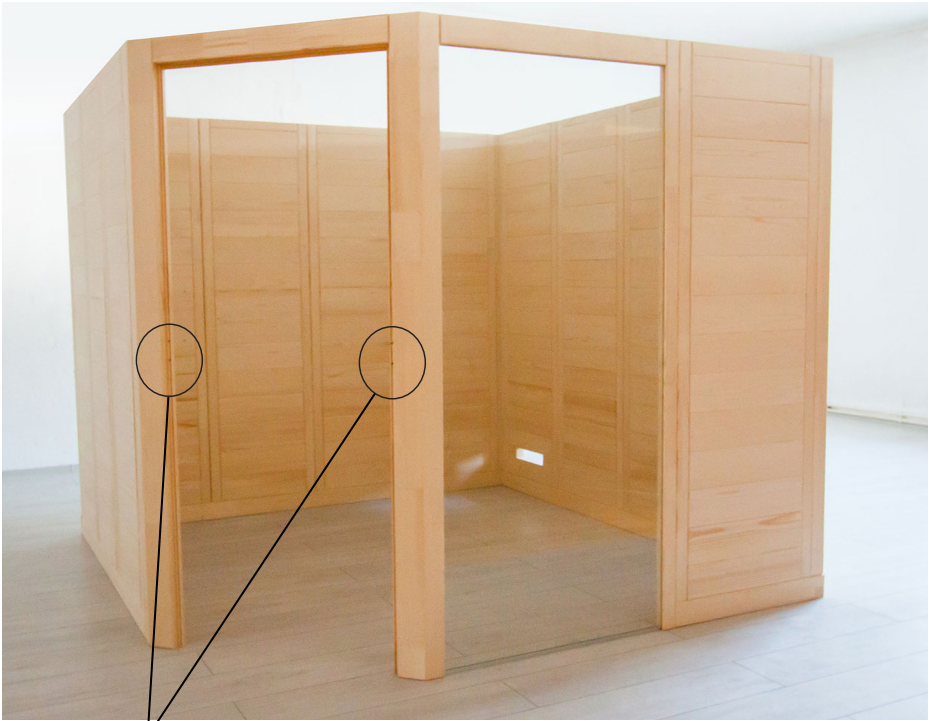

2.3. Montage du toit

Baguettes d'appui de toit



Vis 4 x 70 mm

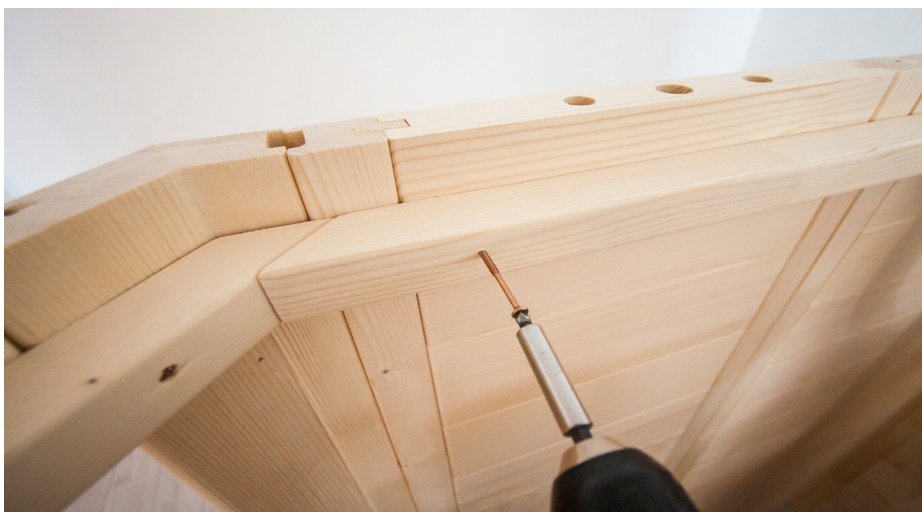

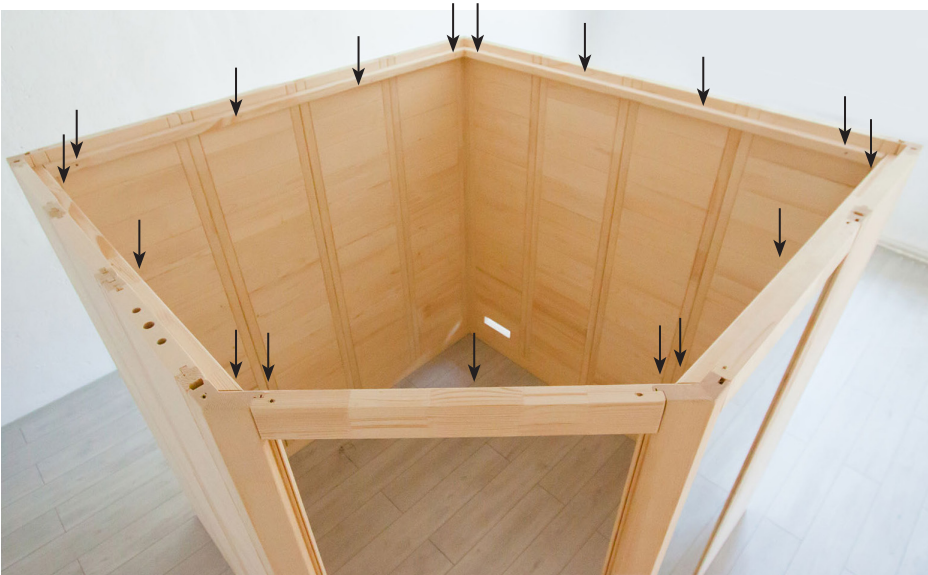

17 vis 4 x 70 mm

Éléments du toit

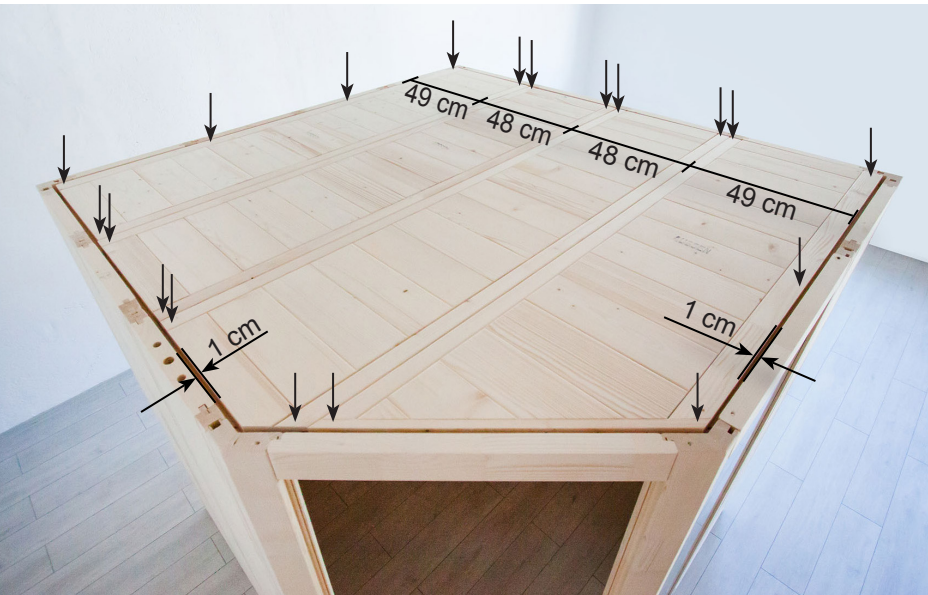

Foret de 3 mm, 19 vis 4 x 70 mm

2.4. Montage du registre d'aération



Foret de 3 mm, 4 vis 3 x 40 mm

2.5. Montage de l'équipement intérieur

Baguettes d'appui de banc

Foret de 3 mm, 3 vis 5 x 70 mm



2 vis 4 x 60 mm

Foret de 3 mm, 3 vis 5 x 70 mm

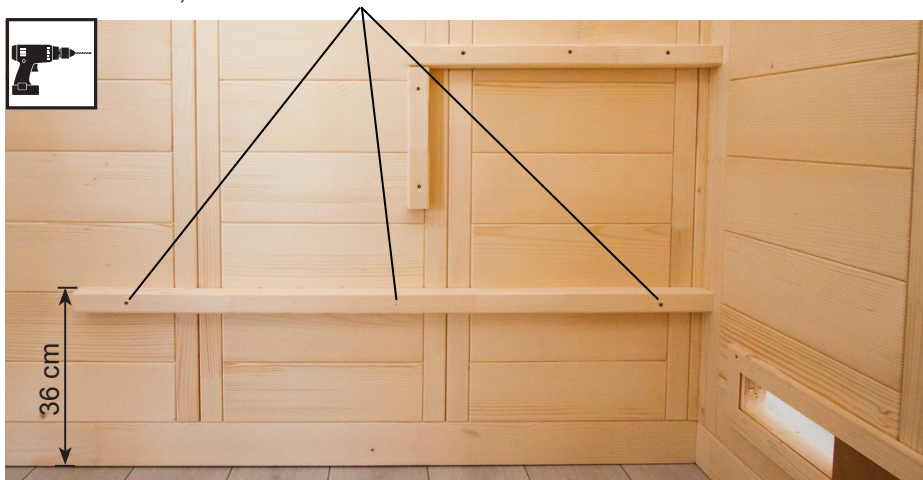

Foret de 3 mm, 3 vis 5 x 70 mm

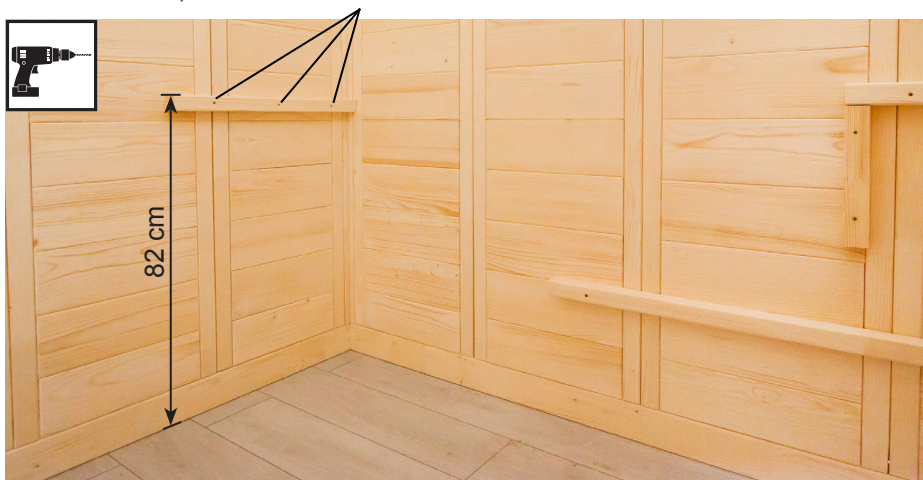

Baguette d'appui de banc avec cache devant la pièce en verre

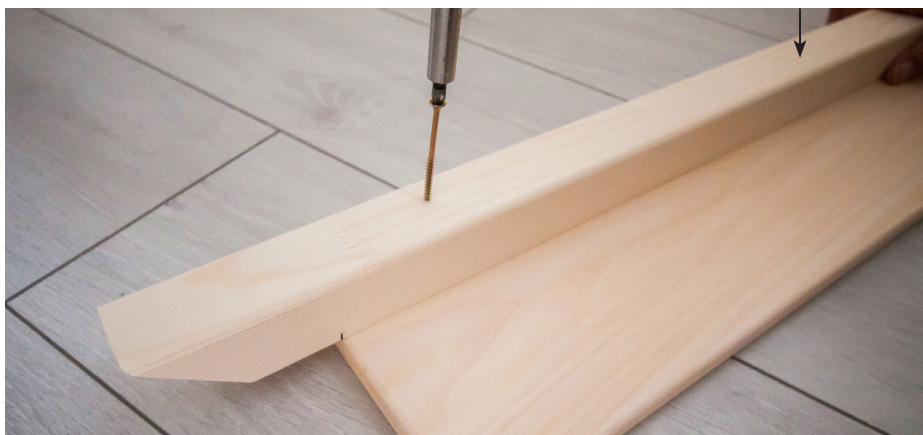
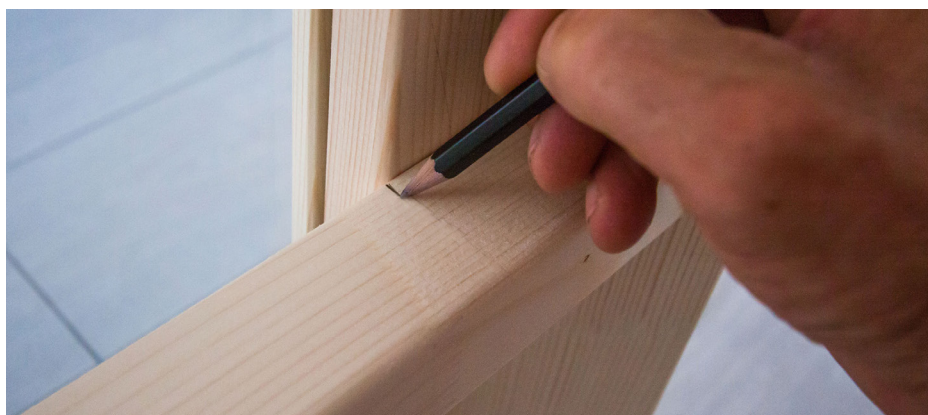

2 vis 4 x 60 mm

FR



3 vis 5 x 70 mm



3 vis 5 x 70 mm
2 vis 4 x 60 mm

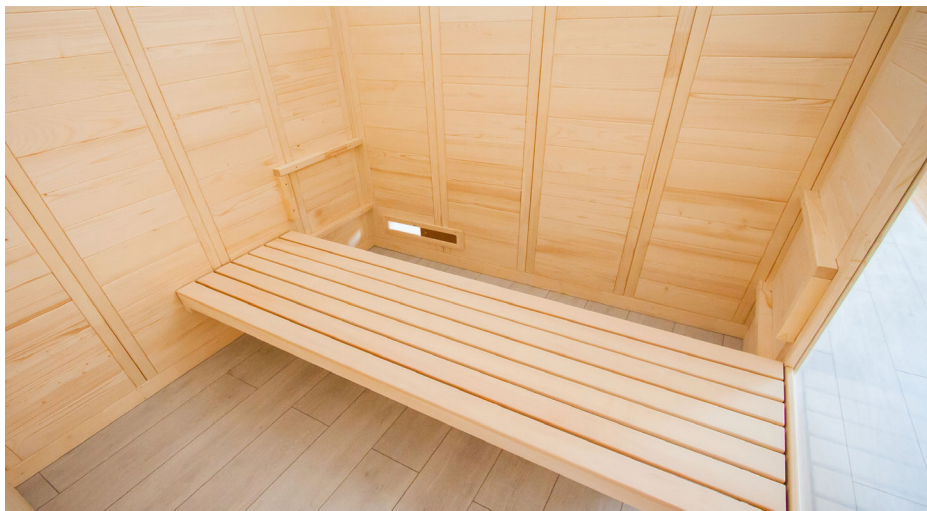

Écran de banc

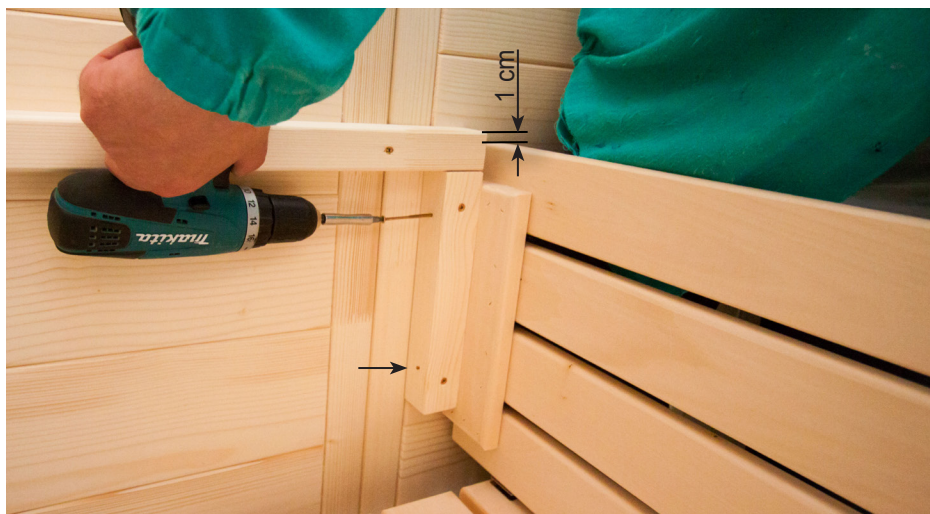

FR

4 vis 4 x 60 mm

Banc

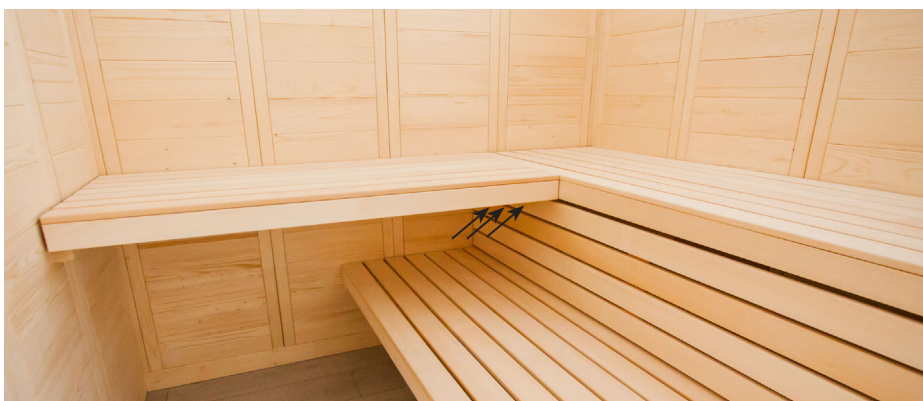

Foret de 3 mm, 3 vis 5 x 70 mm

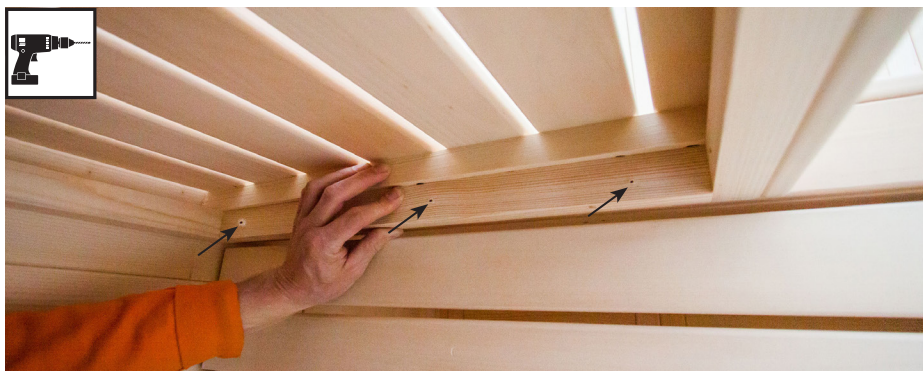

Dossier



Foret de 3 mm, 6 vis 3 x 40 mm



FR

2.6. Montage des accessoires

Éclairage de sauna



Mise en place des ampoules
(non compris dans la livraison)



Foret de 3 mm, 2 vis

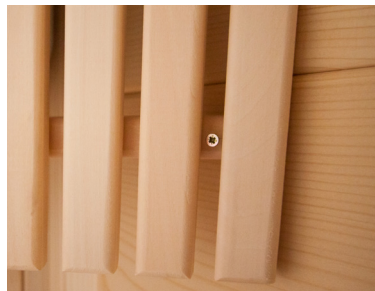

4 vis 3 x 40 mm

Grille de protection du poêle

Avant le montage de la grille de protection du poêle, percez la sortie pour le câble du poêle dans l'élément électrique.



4 vis 3 x 40 mm

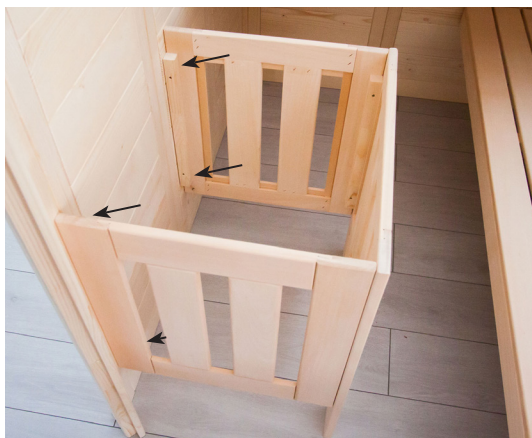
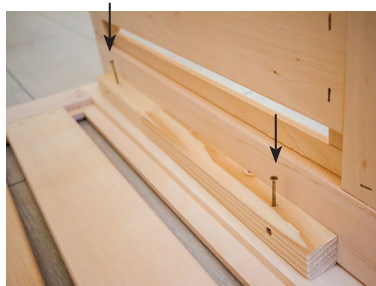

4 vis 3 x 40 mm



2.7. Montage de la porte en verre



L'alésage inférieur de la poignée de porte se trouve à une hauteur de 92,4 cm. L'orientation des ferrures est effectuée en ajustant/tournant les deux armatures en plastique.

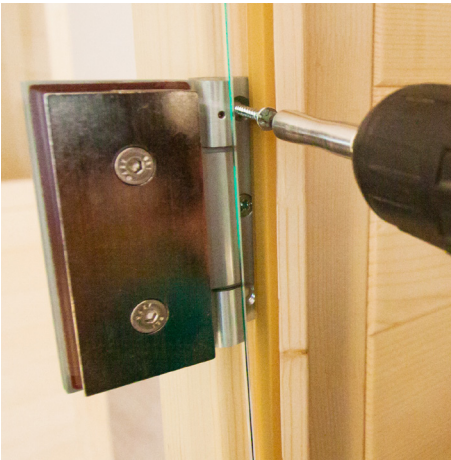
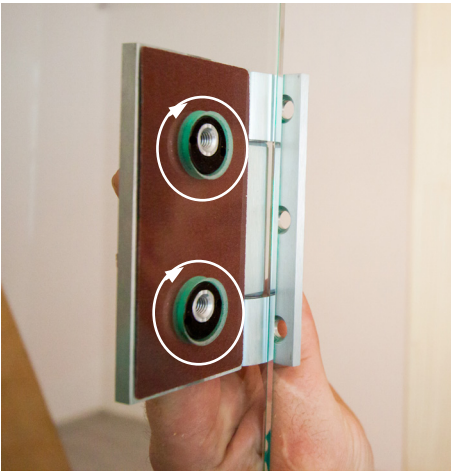

Poignée de porte et tôle extérieure

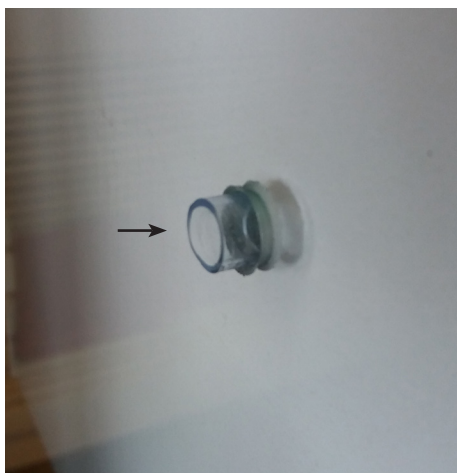

Introduction de la bague en silicone dans les alésages



Pose des rondelles de calage en plastique pour poignée inox



2.8. Montage de la couronne



Ne montez la couronne qu'après avoir inséré les câbles vers le poêle de sauna et la commande de sauna. La baguette au niveau de l'élément électrique doit éventuellement être coupée.



Foret de 3 mm, 9 vis 3 x 40 mm

2.9. Montage de la baguette couvre-joint



Ne montez la baguette couvre-joint qu'après avoir inséré les câbles menant au poêle de sauna et à la commande de sauna. La baguette au niveau de l'élément électrique doit éventuellement être coupée.



14 vis 3 x 40 mm

3. Plan

3.1. Plan « à gauche »

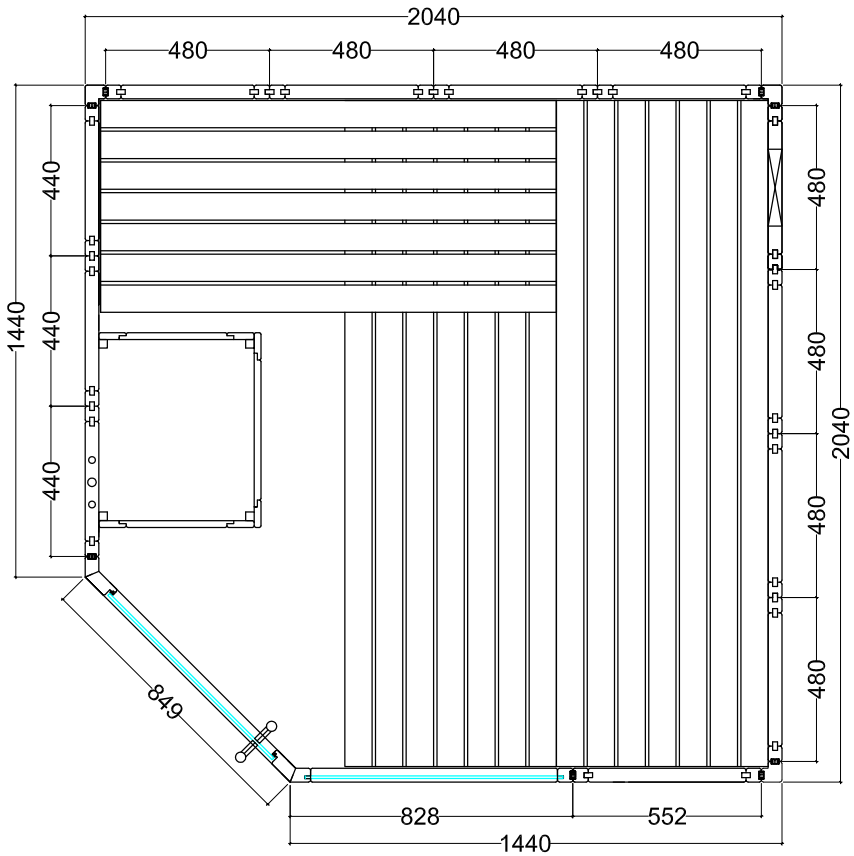

3.2. Plan « à droite »

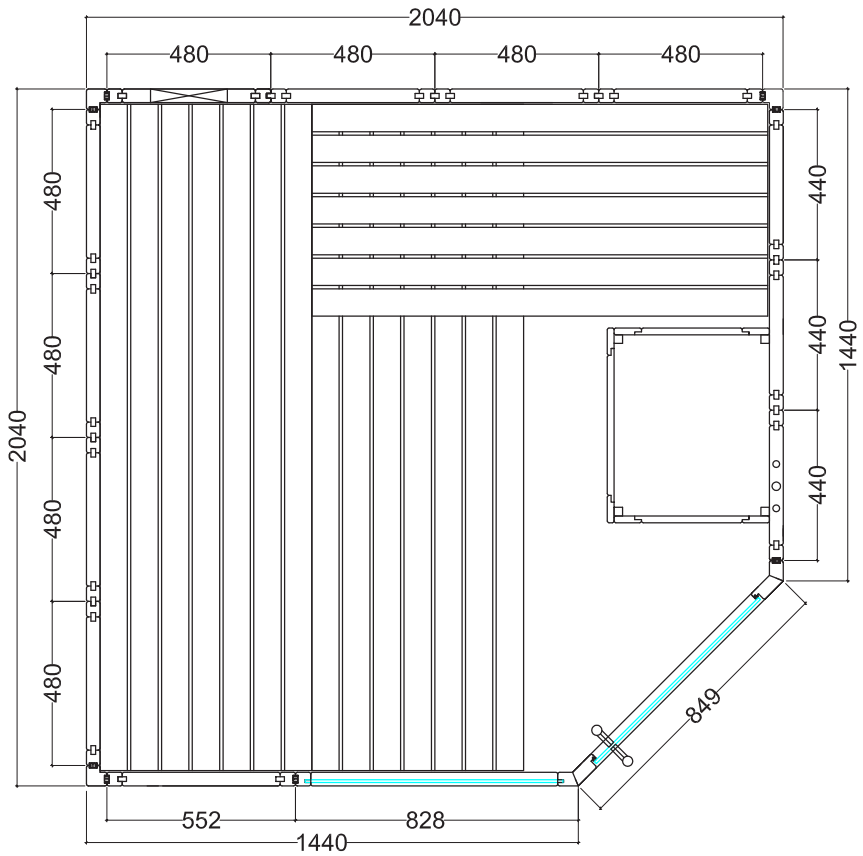

3.3. Modifications lors du montage selon le plan « à droite » Pour le montage de montants d'angle et de montants pour le verre (page 13)

Retirez les multiclips pour montant d'angle et montant pour le verre.
 Utilisez les gabarits fournis pour le nouveau positionnement des multiclips.

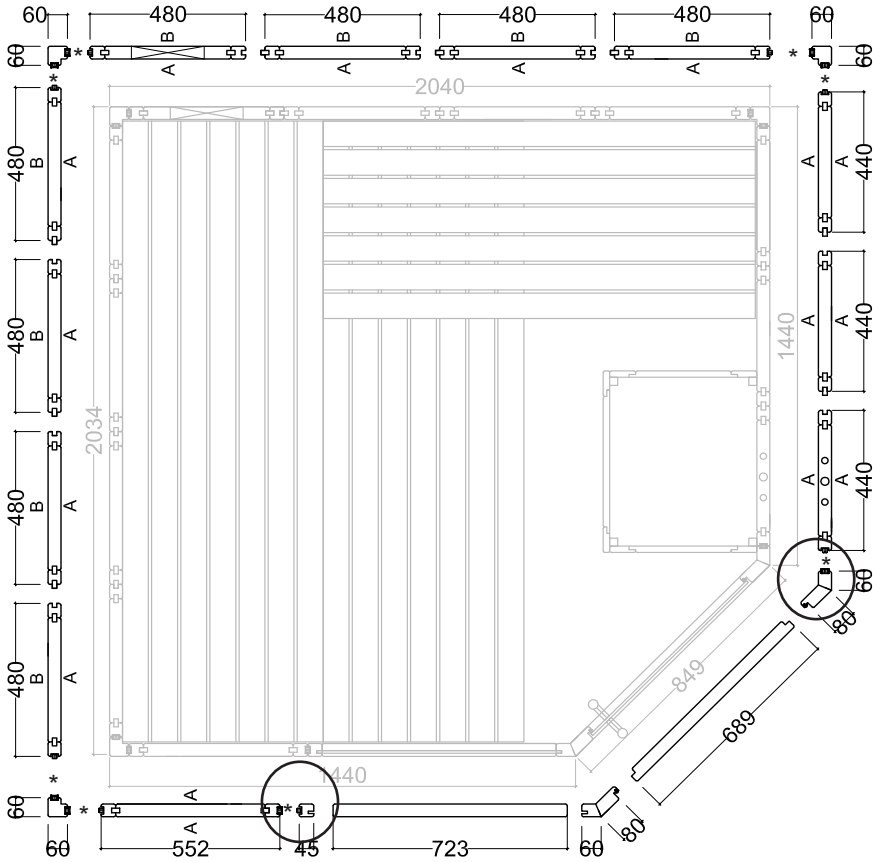

* Multiclips



FR





sentiotec GmbH | Division of Harvia Group | Oberregauer Straße 48, A-4844 Regau
T +43 (0) 7672/277 20-567 | F -801 | info@sentiotec.com | www.sentiotec.com

Sauna in legno massiccio

ALASKA CORNER

206 x 206 x 204 cm

ISTRUZIONI DI MONTAGGIO
Italiano



IT

Indice

1. Preparazione per il montaggio	3
1.1. Attrezzi necessari	4
1.2. Manutenzione e pulizia	5
1.3. Smaltimento	5
1.4. Elenco dei pezzi ALASKA CORNER	6
2. Montaggio della cabina	8
2.1. Montaggio del telaio di base	8
2.2. Montaggio degli elementi parete	9
2.3. Montaggio del tetto	17
2.4. Montaggio del pannello scorrevole di aerazione	19
2.5. Montaggio dell'allestimento interno	19
2.6. Montaggio accessori	26
2.7. Montaggio della porta in vetro	28
2.8. Montaggio del coronamento tetto	30
2.9. Montaggio del listello di copertura del tetto	31
3. Pianta	32
3.1. Pianta "a sinistra"	32
3.2. Pianta "a destra"	33
3.3. Differenze di montaggio per la pianta "a destra"	34

1. Preparazione per il montaggio

Leggere con attenzione le presenti istruzioni di montaggio e conservarle in prossimità della sauna. In questo modo è possibile controllare in qualsiasi momento le informazioni relative al prodotto.



Le presenti istruzioni di montaggio si trovano anche nella sezione download del nostro sito web all'indirizzo: www.sentiotec.com/downloads.

Indicazioni importanti:

- Prima di iniziare i lavori, controllare in base all'elenco dei pezzi se tutti i singoli componenti sono stati effettivamente forniti. Se eccezionalmente dovessero mancare dei singoli componenti, contattare il proprio fornitore entro 14 giorni dal ricevimento della cabina.
- L'ambiente in cui la cabina della sauna viene montata deve essere asciutto e garantire la circolazione dell'aria richiesta.
- Il pavimento deve essere orizzontale e uniforme, preferibilmente in pietra o piastrelle.
- Per i lavori di montaggio della cabina è necessaria un'altezza minima libera di 230 cm.
- Mantenere una distanza minima dalle pareti di 5 cm.
- I componenti in legno da utilizzare all'interno non devono essere trattati con impregnante.
- Per il montaggio è richiesto l'aiuto di una seconda persona.
- Il legno è un prodotto naturale che può gonfiarsi, ritirarsi o deformarsi anche se immagazzinato correttamente. In fase di montaggio potrebbe quindi essere necessario applicare una certa forza.
- Tutte le connessioni a vite devono essere preforate.

Attenzione!

Il collegamento elettrico deve essere eseguito da elettricisti specializzati o da persone con una qualifica simile.

1.1. Attrezzi necessari

- Martello e pezzo di legno oppure martello in gomma
- Avvitatore elettrico con punte per viti con testa a croce e viti Torx
- Metro a nastro avvolgibile
- Punta per trapano da 3 mm, 10 mm, 20-30 mm (per cavo elettrico della stufa per sauna)
- Livella a bolla
- Chiave a brugola da 1,5 mm
- Cutter
- Scala
- Seghetto



Questo simbolo indica consigli e indicazioni utili



Preforatura



Taglio alla lunghezza effettiva mediante seghetto



Verifica dell'ortogonalità:

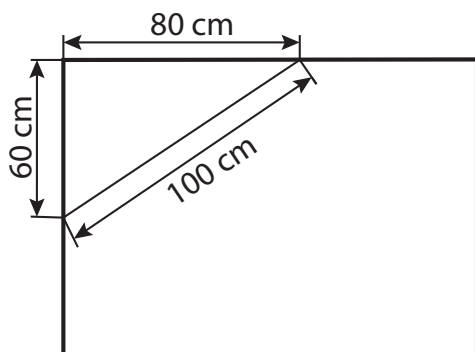

1.2. Manutenzione e pulizia

- La sauna deve essere pulita con un panno umido. Utilizzare solo acqua calda senza detersivi.
- Se la sauna non viene utilizzata per un tempo prolungato, si consiglia di riscaldare la cabina una volta al mese.



Le tasche di resina non sono motivo di reclamo perché nel legno di abete rosso sono sempre presenti e durante la selezione non è possibile rilevare a quale profondità si trovino.

Quando sono appena al di sotto della superficie, con lo sviluppo del calore si rompono e possono “essudare”.

Rimuovere la resina fuoriuscita con un panno imbevuto di acetone. Se sono presenti solo gocce di resina, lasciarle indurire e poi raschiarle con cautela usando un coltello.

1.3. Smaltimento



- Smaltire i materiali dell’imballaggio conformemente alle normative sullo smaltimento vigenti.
- I vecchi apparecchi contengono materiali riciclabili ma anche sostanze dannose. Non gettare mai l’apparecchio usato insieme ai rifiuti non riciclabili, bensì smaltirlo in conformità alle norme vigenti a livello locale.

1.4. Elenco dei pezzi ALASKA CORNER

Pz.	Denominazione	Dimensioni
Telaio di base		
2	Telaio di base	204 x 9 x 4 cm
1	Telaio di base	138 x 9 x 4 cm
1	Telaio di base	61,2 x 9 x 4 cm
Elementi parete		
4	Elementi parete A/B	193 x 48 x 4 cm
3	Elementi parete A/B con multclip	193 x 48 x 4 cm
1	Elemento per cavi elettrici A/A con multclip	193 x 44 x 4 cm
1	Elemento di aerazione A/B con multclip	193 x 48 x 4 cm
1	Elemento parete A/A con multclip	193 x 44 x 4 cm
1	Elemento parete A/A	193 x 44 x 4 cm
1	Elemento parete A/A con multclip	193 x 55,2 x 4 cm
1	Elemento sopraporta	69,3 x 10,1 x 4 cm
1	Elemento sopra elemento in vetro	72,3 x 8,6 x 4 cm
Elementi del tetto		
2	Elementi tetto A/B	194 x 48 x 4 cm
1	Elemento del tetto A/B	194 x 49 x 4 cm
1	Elemento tetto A/A inclinato	186 x 49 x 4 cm
Montante angolare		
3	Montante angolare 90° con multclip	193 x 6 x 6 cm
1	Montante angolare 45° vicino a porta con multclip	202 x 7,8 x 4 cm
1	Montante angolare 45° vicino a porta con scanalatura	202 x 7,8 x 4 cm
1	Montante per elemento in vetro, scanalatura di 8 mm con multclip	202 x 4,5 x 4 cm
Listelli di supporto		
1	Listello di supporto tetto	197 x 4 x 4 cm
1	Listello di supporto tetto	193 x 4 x 4 cm
2	Listelli di supporto del tetto 1 x 45°	141,6 x 4 x 4 cm
1	Listello di supporto del tetto 2 x 45°	89,7 x 4 x 4 cm
1	Listello di copertura del tetto	196 x 1,2 x 4 cm
1	Listello di copertura del tetto	192 x 1,2 x 4 cm
2	Listelli di copertura del tetto 1 x 22,5°	141,2 x 1,2 x 4 cm
1	Listello di copertura del tetto 1 x 22,5°	83,2 x 1,2 x 4 cm
1	Listello di supporto panca 1 x 45°	142,3 x 4 x 4 cm
1	Listello di supporto panca	120 x 4 x 4 cm
3	Listelli di supporto panca	58 x 4 x 4 cm
2	Listelli di montaggio per pannello di rivestimento panca	26 x 4 x 4 cm

Pz.	Denominazione	Dimensioni
Allestimento interno		
2	Panche	195 x 62 x 9 cm
1	Panca	133,5 x 62 x 9 cm
1	Listello di copertura panca	72,3 x 14 x 2 cm
2	Schienali	186 x 26 x 5 cm
1	Pannello di rivestimento panca	195 x 35 x 5 cm
1	Griglia di protezione stufa, 3 pz. 1 x 57 x 75 cm, 2x 45,5 x 55 cm	57 x 475 x 75 cm
1	Griglia di fondo	70 x 53 x 4 cm
2	Poggiatesta	43 x 25 x 7 cm
1	Griglia di protezione lampada	38 x 32 x 4 cm
1	Pannello scorrevole di aerazione	52 x 14 x 1,5 cm
Elementi in vetro		
1	Porta in vetro	191,5 x 68 x 0,8 cm
1	Elemento in vetro	194,5 x 75,5 x 0,8 cm
Listelli di coronamento tetto		
2	Listelli di coronamento tetto 1 x 22,5°	149,8 x 6 x 4 cm
1	Listello di coronamento tetto 1 x 22,5°	86,5 x 6 x 4 cm
Accessori		
1	Profilato a U in alluminio	72,3 x 1,2 x 1,5 cm
1	Set maniglia porta legno/Nirosta	
1	2 cerniere per porta 8653-02	
1	Magnete per porta, lamierino di battuta	
1	Lampada	
1	Cavo in silicone da 3 metri 5 x 2,5 mm ²	
1	Cavo in silicone da 3 metri 3 x 1,5 mm ²	
1	Dima per montaggio multclip	
1	Set di materiale di montaggio	
1	Istruzioni di montaggio	

2. Montaggio della cabina

La cabina può essere montata “a sinistra” o “a destra”; consultare le piante a pagina 32 e pagina 33.

2.1. Montaggio del telaio di base

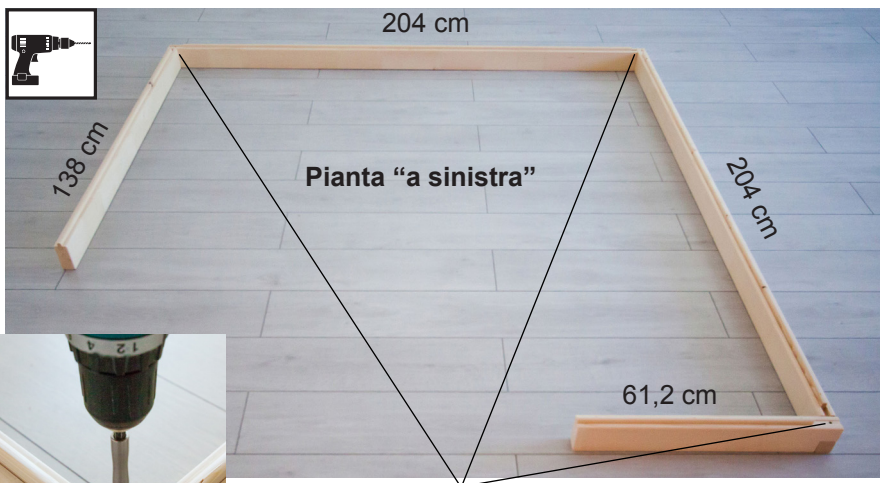

Punta per trapano da 3 mm, 3 viti 4 x 70 mm

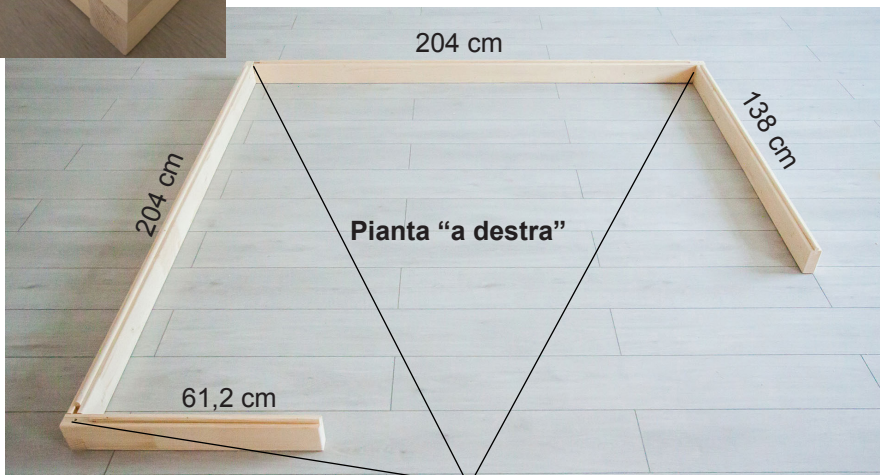
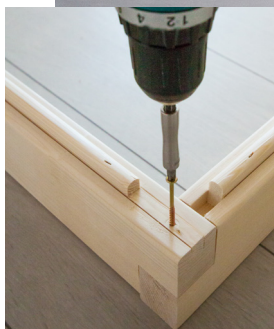

Punta per trapano da 3 mm, 3 viti 4 x 70 mm

2.2. Montaggio degli elementi parete

I montanti angolari vengono collegati agli elementi parete mediante "multiclip". Gli altri elementi parete vengono collegati con scanalatura e linguetta e avvitati tra loro.



A: indica sempre il lato a vista ed è riportata sulla parte superiore degli elementi parete.

Attenzione!

Di seguito viene descritta la sequenza di montaggio per la pianta "a sinistra". Per le differenze di montaggio per la pianta "a destra" – vedi pagina 33.

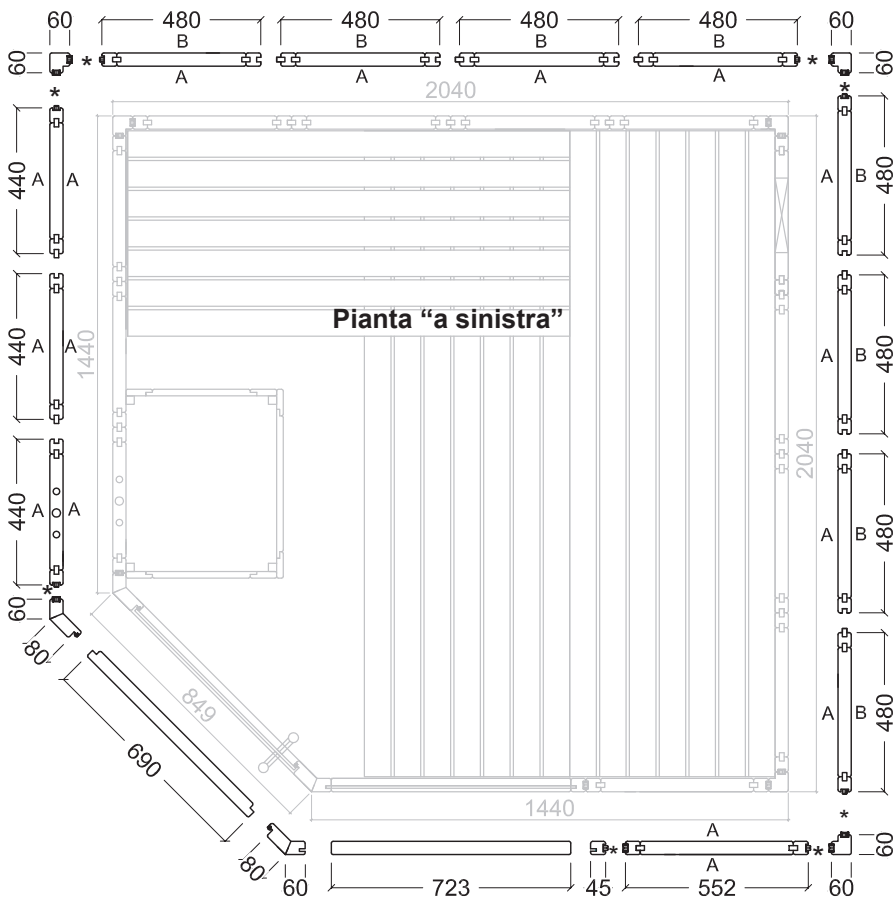

* Multiclip

Montaggio del montante angolare con elemento parete

Assemblare sul pavimento gli elementi parete con i montanti angolari e successivamente montarli sul telaio di base.

Innestare i montanti angolari dall'alto verso il basso sugli elementi parete. Nel farlo, prestare attenzione all'orientamento corretto delle "multiclip" (vedere sotto). I montanti devono essere a filo con gli elementi parete.

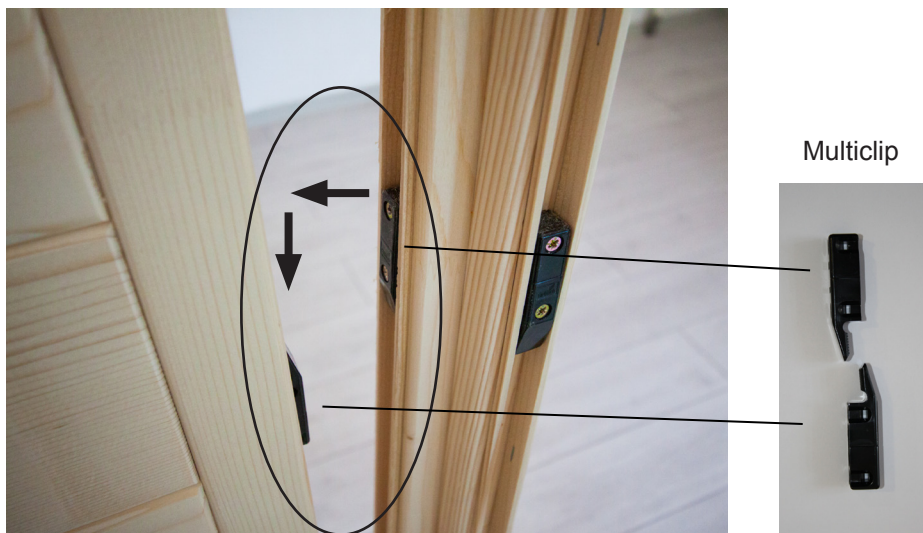

Montaggio degli elementi parete

L'elemento per cavi elettrici ha dei fori per la posa dei cavi. Per la posizione, vedere le piante a pagina 32 e pagina 33.



Elemento per cavi elettrici

Collegamento a vite degli elementi parete

Verificare l'ortogonalità degli elementi parete prima di avvitarli tra loro.
Seguire l'indicazione a pagina 4.



Punta per trapano da 3 mm, 8 viti 4 x 70 mm

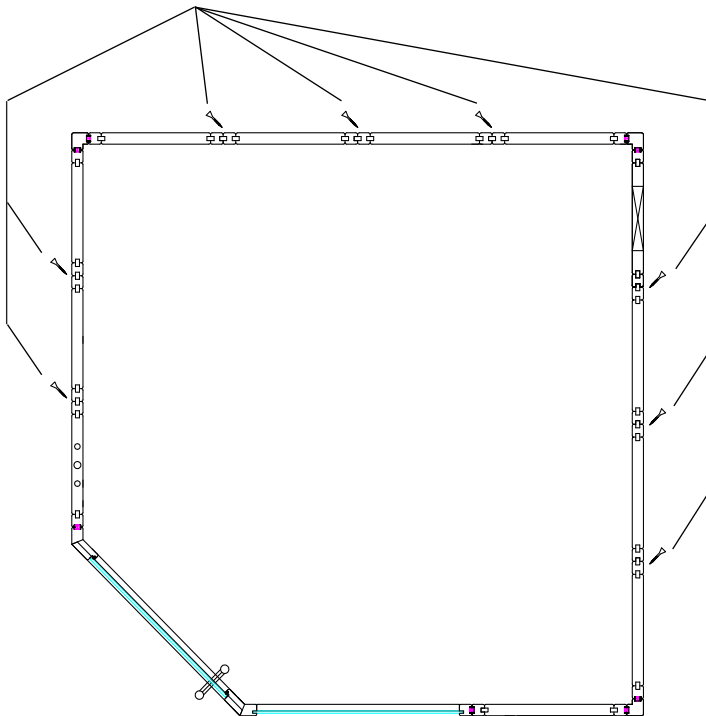

Montante angolare e montante per vetro



Elemento in vetro

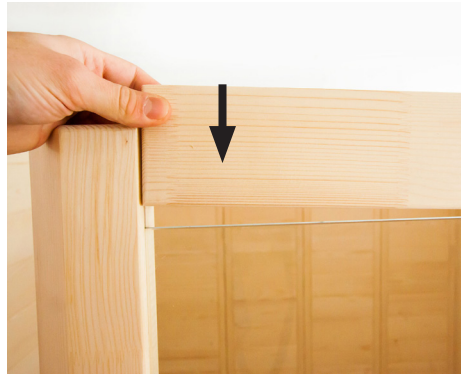

Punta per trapano da 3 mm,
1 vite 4 x 70 mm



Punta per trapano da 3 mm,
1 vite 4 x 70 mm

Elemento sopraporta



IT

Punta per trapano da 3 mm,
1 vite 4 x 70 mm



Punta per trapano da 3 mm,
1 vite 4 x 70 mm

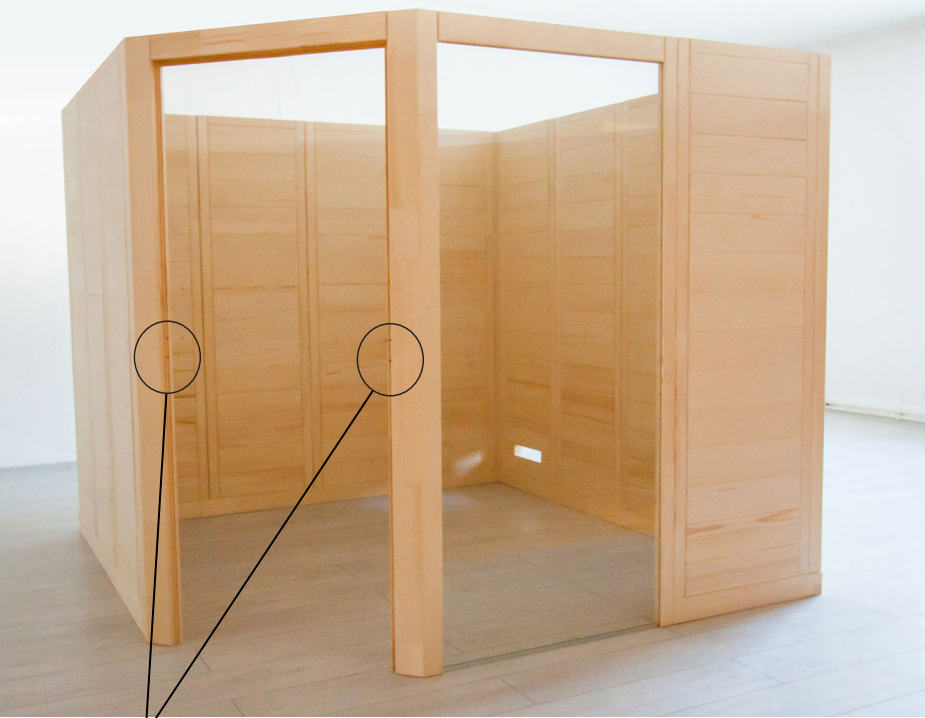

2.3. Montaggio del tetto

Listelli di supporto del tetto



Viti 4 x 70 mm

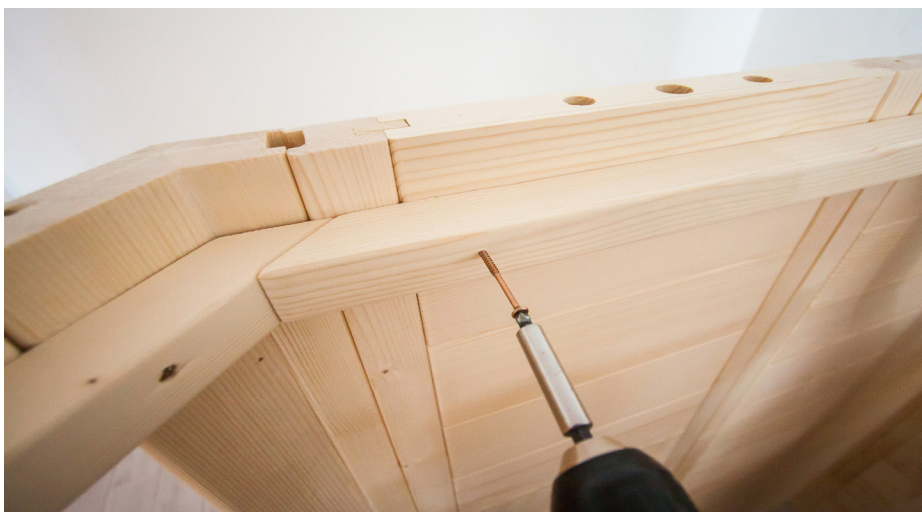

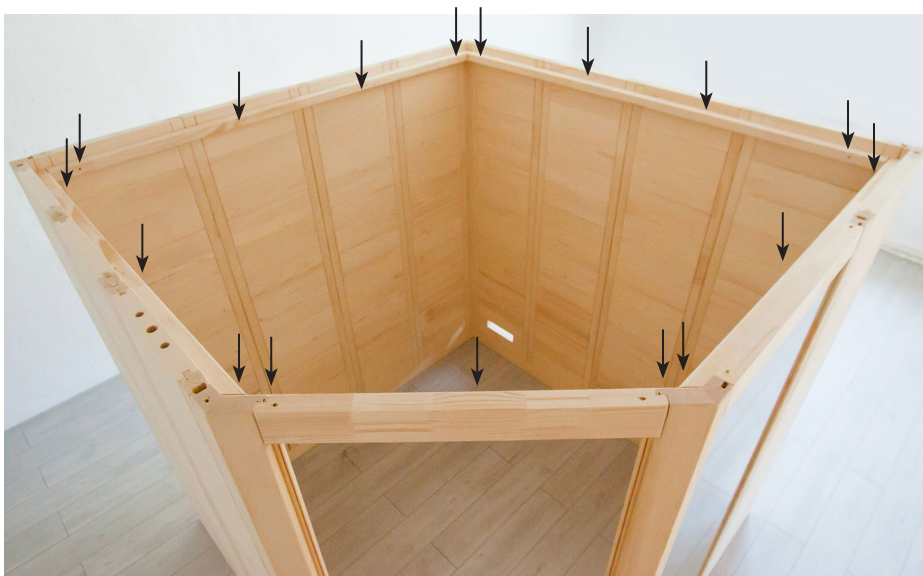

17 viti 4 x 70 mm

Elementi del tetto

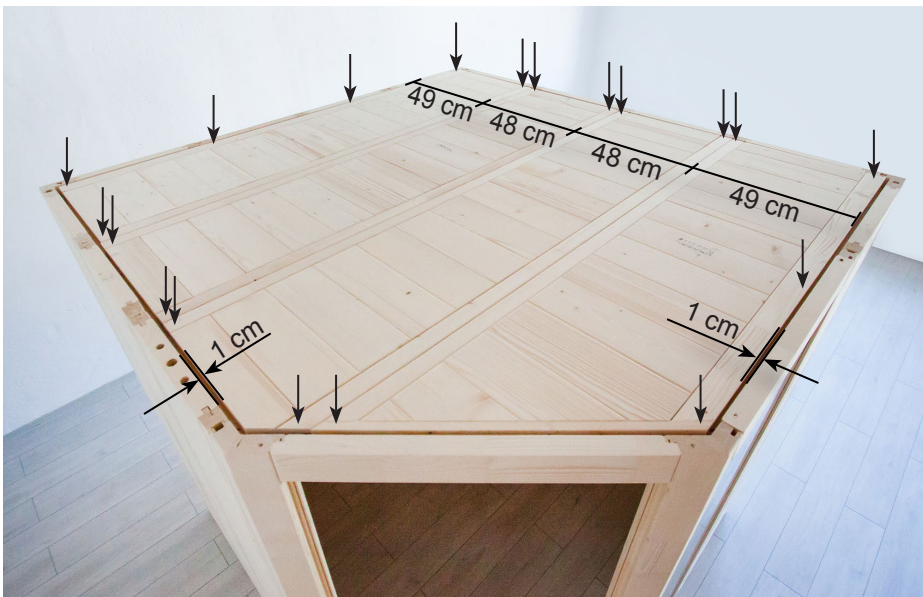

Punta per trapano da 3 mm, 19 viti 4 x 70 mm

2.4. Montaggio del pannello scorrevole di aerazione



Punta per trapano da 3 mm, 4 viti 3 x 40 mm

2.5. Montaggio dell'allestimento interno

Listelli di supporto panca

Punta per trapano da 3 mm, 3 viti 5 x 70 mm



2 viti 4 x 60 mm

Punta per trapano da 3 mm, 3 viti 5 x 70 mm

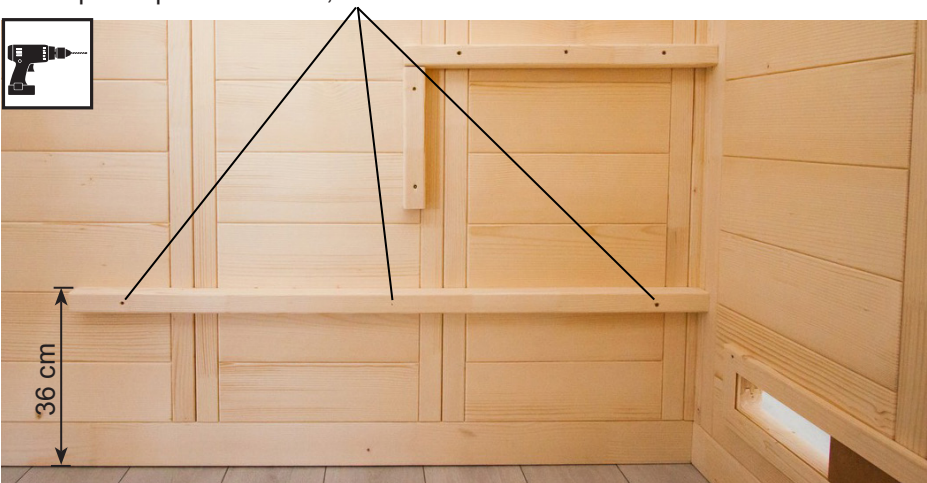

Punta per trapano da 3 mm, 3 viti 5 x 70 mm

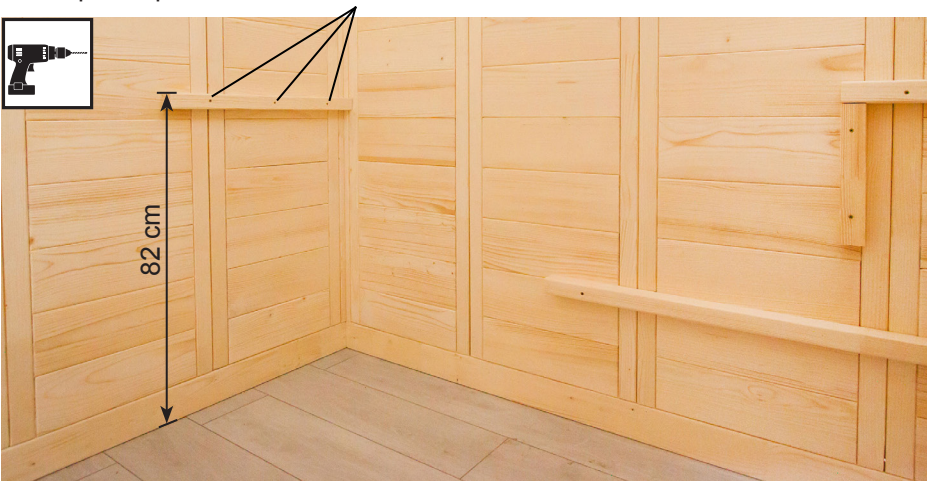

Listello di supporto panca con pannello di copertura

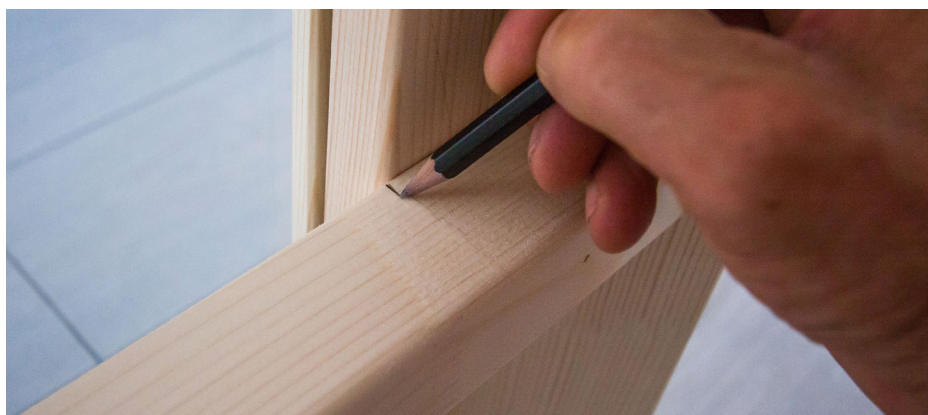

IT

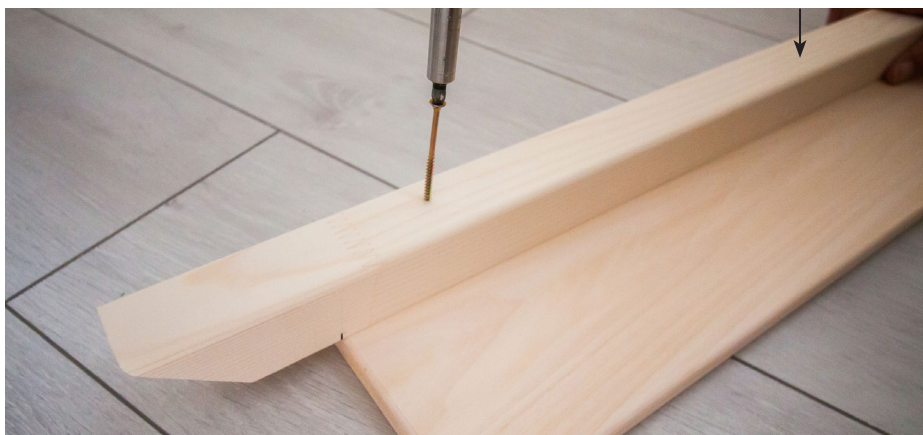

2 viti 4 x 60 mm



3 viti 5 x 70 mm



3 viti 5 x 70 mm
2 viti 4 x 60 mm

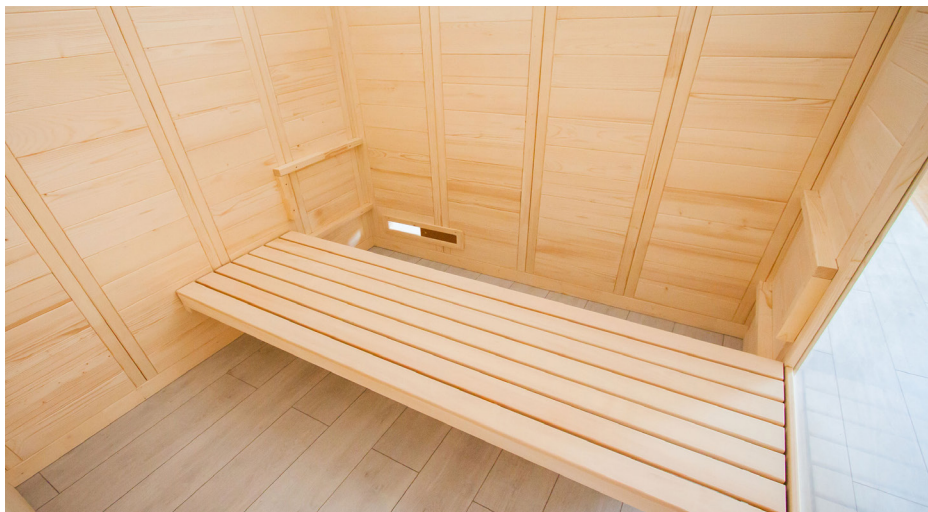

Pannello di rivestimento panca

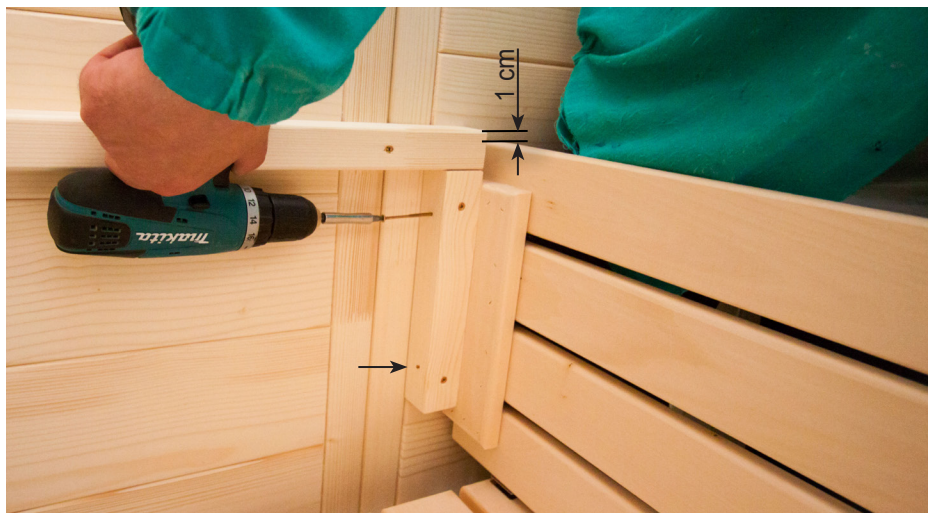

4 viti 4 x 60 mm

Panca

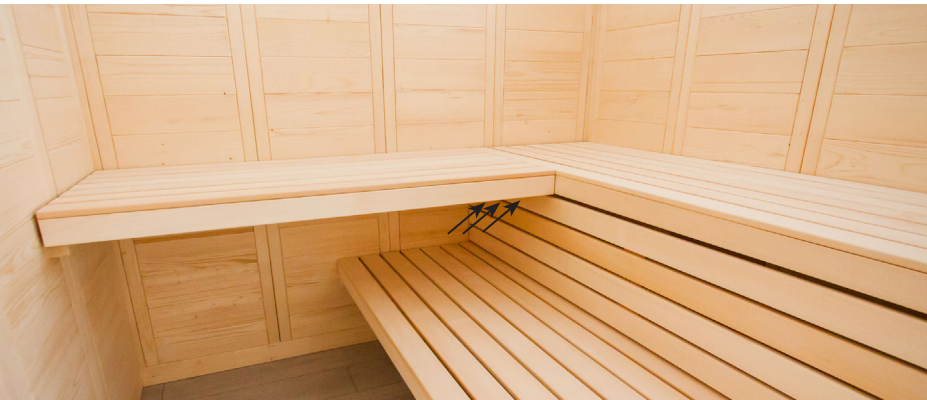

Punta per trapano da 3 mm, 3 viti 5 x 70 mm



Schienale

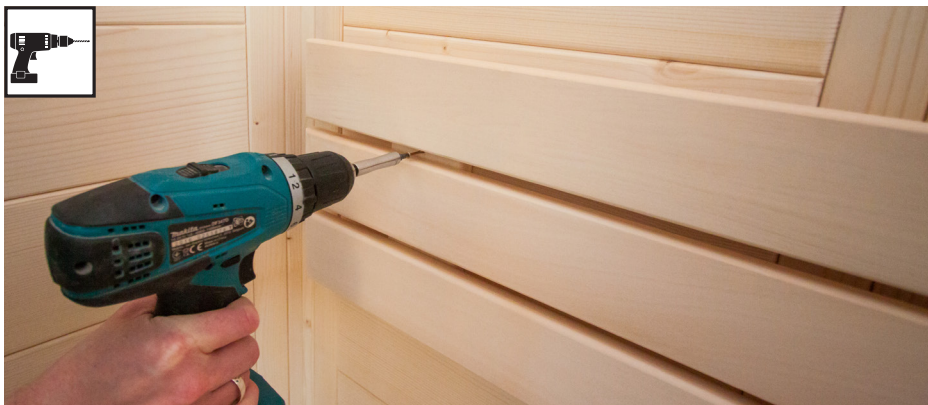

Punta per trapano da 3 mm, 6 viti 3 x 40 mm



2.6. Montaggio accessori

Lampada



Inserire una lampadina
(non compresa nella fornitura)



Punta per trapano da 3 mm, 2 viti

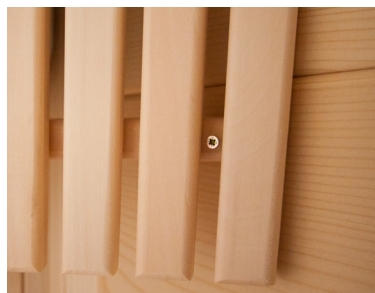
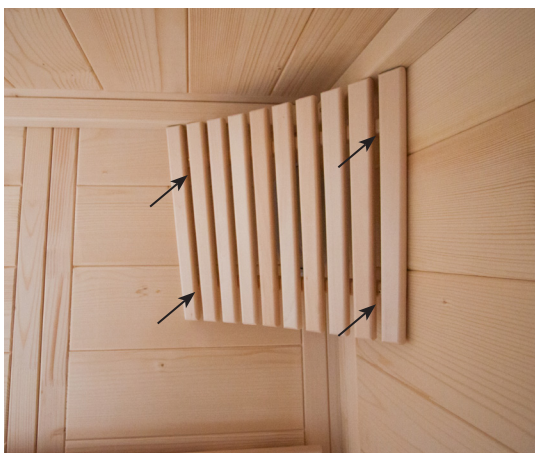

4 viti 3 x 40 mm

Griglia di protezione stufa

Prima del montaggio della griglia di protezione della stufa eseguire il foro di uscita per il cavo della stufa nell'elemento per cavi elettrici.



4 viti 3 x 40 mm

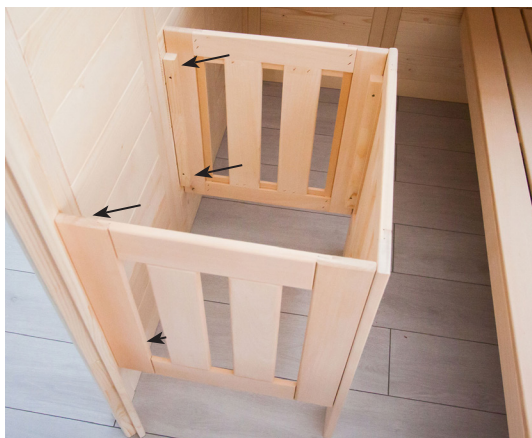
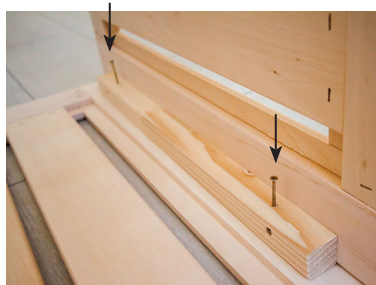

4 viti 3 x 40 mm



2.7. Montaggio della porta in vetro



Il foro inferiore della maniglia porta è a un'altezza di 92,4 cm.
L'orientamento delle guarnizioni viene eseguito regolando / ruotando i due inserti in plastica.

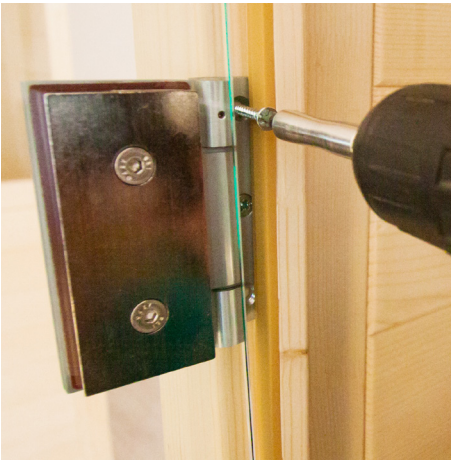
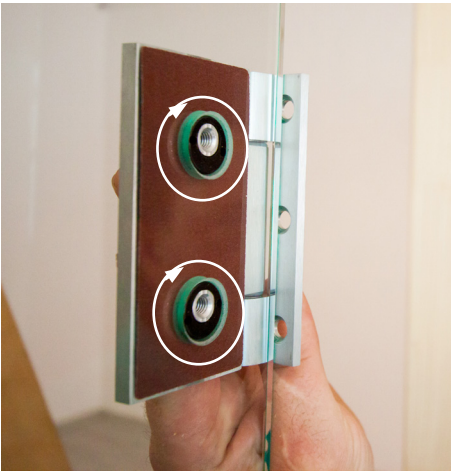

Maniglia porta e lamierino di battuta

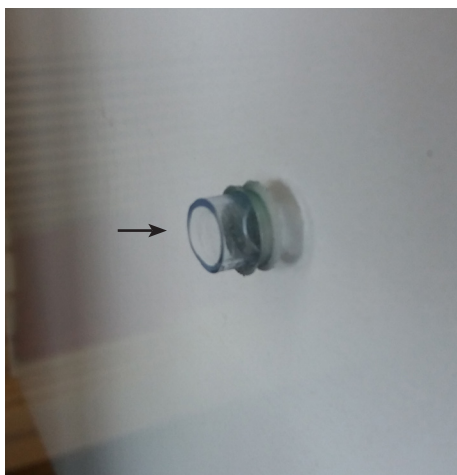

Inserire un anello di silicone nei fori



Applicare rondelle di plastica nelle maniglie Nirosta



2.8. Montaggio del coronamento tetto



Montare il coronamento tetto solo dopo aver inserito i cavi per la stufa della sauna e per il comando della sauna. Se possibile, ritagliare il listello dell'elemento per cavi elettrici.



Punta per trapano da 3 mm, 9 viti 3 x 40 mm

2.9. Montaggio del listello di copertura del tetto



Montare il listello di copertura del tetto solo dopo aver inserito i cavi per la stufa della sauna e per il comando della sauna. Se possibile, ritagliare il listello dell'elemento per cavi elettrici.



14 viti 3 x 40 mm

3. Pianta

3.1. Pianta "a sinistra"

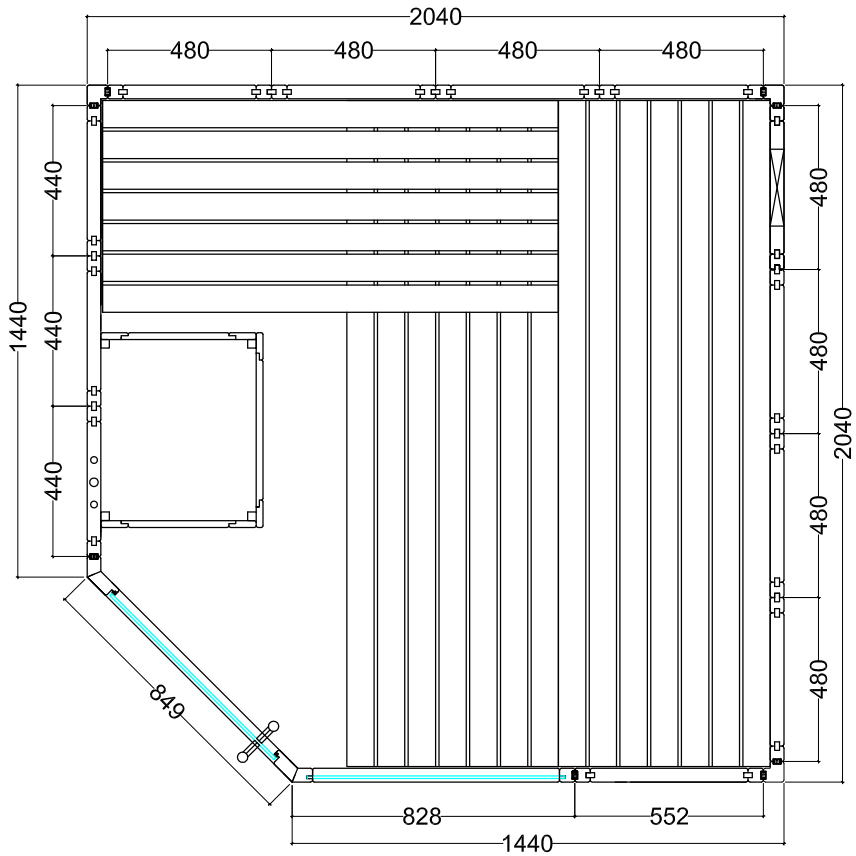

3.2. Pianta "a destra"

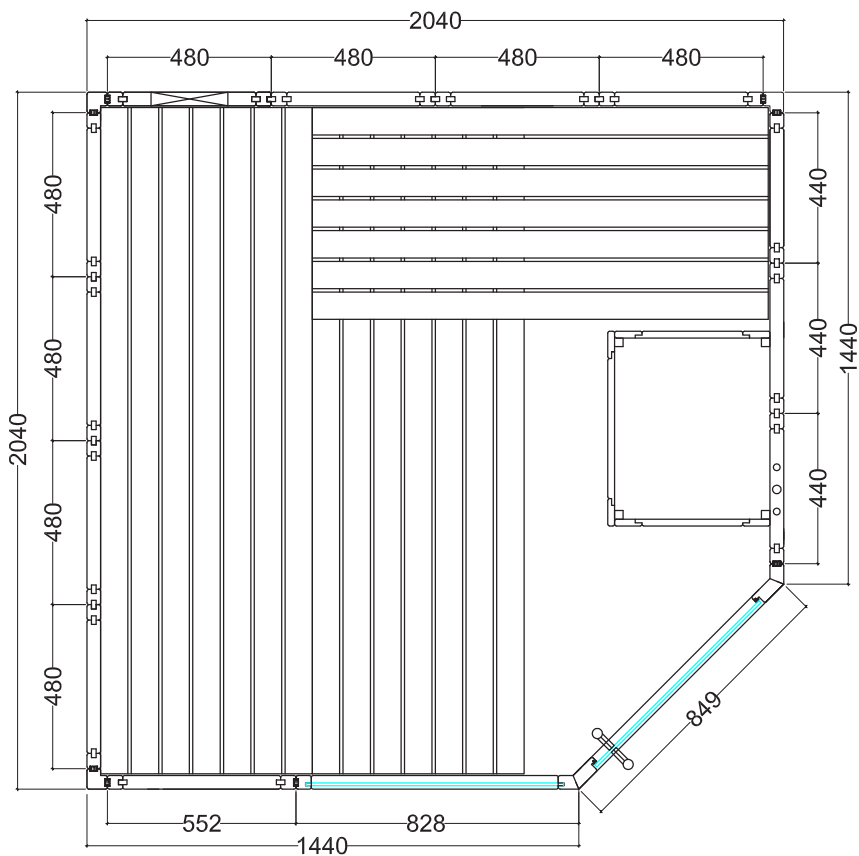

3.3. Differenze di montaggio per la pianta "a destra"

Per il montaggio di montante angolare e montante per il vetro (pagina 13)

Rimuovere le multclip dal montante angolare e dal montante per il vetro.

Utilizzare la dima in dotazione per il nuovo posizionamento dei multclip.

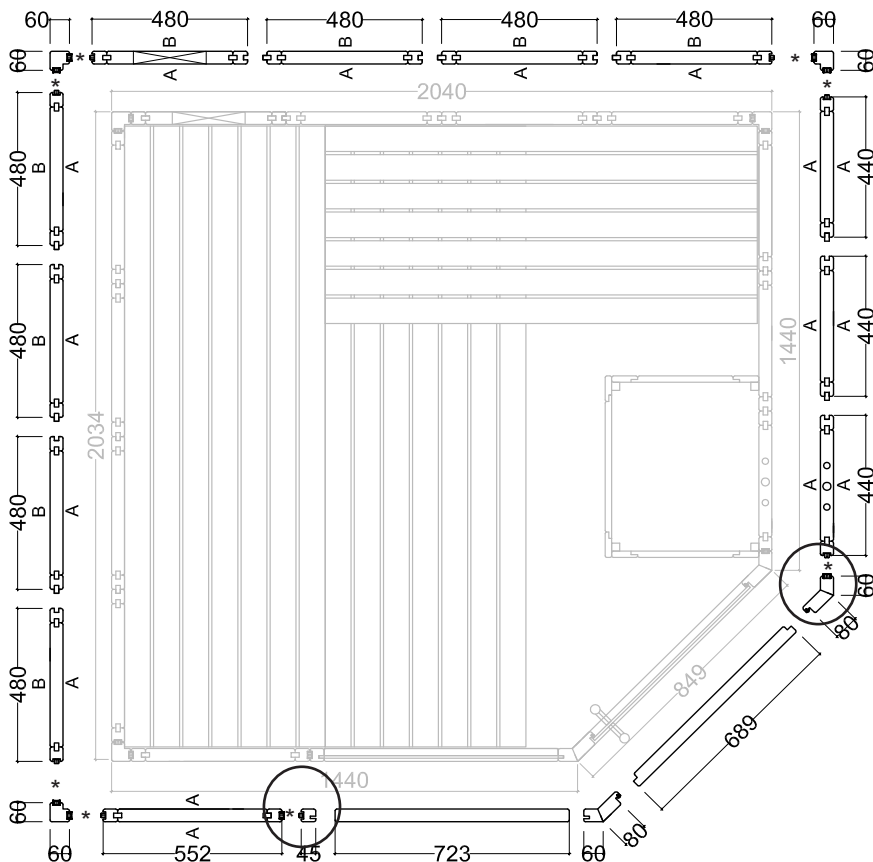

* Multiclip



IT





sentiotec GmbH | Division of Harvia Group | Oberregauer Straße 48, A-4844 Regau
T +43 (0) 7672/277 20-567 | F -801 | info@sentiotec.com | www.sentiotec.com

Sauna z litego drewna

ALASKA

CORNER

206 x 206 x 204 cm

INSTRUKCJA MONTAŻU

Polski



PL

SPIS TREŚCI

1. Przygotowanie montażu	3
1.1. Wymagane narzędzia	4
1.2. Konserwacja i czyszczenie	5
1.3. Utylizacja	5
1.4. Lista części ALASKA CORNER	6
2. Montaż kabiny	8
2.1. Montaż ramy podłogowej	8
2.2. Montaż elementów ściennych	9
2.3. Montaż dachu	17
2.4. Montaż zasuwki do wentylacji	19
2.5. Montaż urządzenia wnętrza	19
2.6. Montaż akcesoriów	26
2.7. Montaż drzwi szklanych	28
2.8. Montaż gzymsu	30
2.9. Montaż listwy osłonowej dachu	31
3. Rzut	32
3.1. Rzut „na lewą stronę”	32
3.2. Rzut „na prawą stronę”	33
3.3. Różnice obowiązujące w przypadku montażu wg rzutu „na prawą stronę”	34

1. Przygotowanie montażu

Przeczytaj uważnie niniejszą instrukcję montażu. Przechowuj ją w pobliżu sauny. Dzięki temu możliwe będzie w każdej chwili przeczytanie informacji o produkcie.



Niniejsza instrukcja montażu jest również dostępna do pobrania na naszej stronie internetowej www.sentiotec.com/downloads.

Ważne wskazówki:

- Przed rozpoczęciem pracy na podstawie listy części sprawdź, czy wszystkie części zostały faktycznie dostarczone. Jeśli brakuje którejkolwiek z części, poinformuj sprzedawcę najpóźniej 14 dni po otrzymaniu kabiny.
- Pomieszczenie, w którym zostanie zamontowana kabina sauny, musi być suche i zapewniać odpowiednią cyrkulację powietrza.
- Podłoga musi być pozioma i równa, preferowana podłoga kamienna lub podłoga wyłożona płytkami.
- Aby zamontować kabinę, pomieszczenie musi mieć minimalną wysokość wynoszącą 230 cm.
- Musi zostać zachowana odległość od ściany wynosząca co najmniej 5 cm.
- Części z drewna, które mają być użyte wewnątrz, nie mogą być lakierowane środkami impregnującymi.
- Do montażu potrzebna jest druga osoba.
- Drewno jest naturalnym produktem, który pomimo dobrego przechowywania może pęcznieć, kurczyć się lub wykrzywiać. Z tego powodu podczas montażu może być konieczne użycie siły.
- Wszystkie połączenia gwintowane muszą być nawiercone.

Uwaga!

Podłączenie elektryczne może wykonywać tylko wykwalifikowany elektryk lub osoba posiadająca podobne kwalifikacje.

1.1. Wymagane narzędzia

- Młotek i przekładka z drewna lub młotek gumowy
- Wkrętarka akumulatorowa z bitami do wkrętów krzyżowych i Torx
- Taśma miernicza
- Wiertło o średnicy 3 mm, 10 mm, 20–30 mm (do przewodu zasilającego piec sauny)
- Poziomica
- Klucz imbusowy 1,5 mm
- Nóż uniwersalny
- Drabina
- Piła



Ten symbol oznacza rady i przydatne wskazówki



Wstępne wiercenie



Cięcie na miarę za pomocą piły



Sprawdzenie kąta prostego:

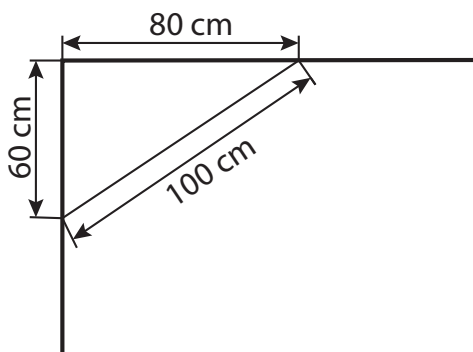

1.2. Konserwacja i czyszczenie

- Sauna powinna być czyszczona wilgotną ściereczką. Używaj tylko ciepłej wody – żadnych detergentów.
- Jeśli sauna nie jest używana przez dłuższy czas, zaleca się rozgrzewanie kabiny raz w miesiącu.



Pęcherze żywiczne nie są podstawą do reklamacji. W drewnie świerkowym często zdarzają się pęcherze żywiczne i podczas jego sortowania nie można ocenić, na jakiej głębokości się one znajdują.

Jeśli znajdują się one tuż pod powierzchnią, przy wzroście temperatury mogą pękać i wypływać.

Żywicę, która wypłynęła, można usunąć za pomocą szmatki zamoczonej w acetonie. Jeśli powstaną tylko kropelki żywicy, należy poczekać, aż stwardnieją, a następnie ostrożnie zeszkrobać nożem.

1.3. Utylizacja



- Utylizuj materiały opakowaniowe zgodnie z obowiązującymi odpowiednimi dyrektywami.
- Zużyte urządzenia zawierają materiały możliwe do powtórnego przetworzenia jak również szkodliwe substancje. Dlatego nie umieszczaj ich w pojemniku na urządzenia nienadające się do powtórnego przetworzenia, lecz utylizuj je zgodnie z lokalnymi przepisami.

1.4. Lista części ALASKA CORNER

Ilość	Nazwa	Wymiar
Rama podłogi		
2	Rama podłogi	204 x 9 x 4 cm
1	Rama podłogi	138 x 9 x 4 cm
1	Rama podłogi	61,2 x 9 x 4 cm
Elementy ścienne		
4	Elementy ścienne A/B	193 x 48 x 4 cm
3	Elementy ścienne A/B z multiklipem	193 x 48 x 4 cm
1	Element elektryczny A/A z multiklipem	193 x 44 x 4 cm
1	Element wentylacyjny A/B z multiklipem	193 x 48 x 4 cm
1	Element ścienny A/A z multiklipem	193 x 44 x 4 cm
1	Element ścienny A/A	193 x 44 x 4 cm
1	Element ścienny A/A z multiklipem	193 x 55,2 x 4 cm
1	Element powyżej drzwi	69,3 x 10,1 x 4 cm
1	Element powyżej elementu szklanego	72,3 x 8,6 x 4 cm
Elementy dachowe		
2	Elementy dachowe A/B	194 x 48 x 4 cm
1	Element dachowy A/B	194 x 49 x 4 cm
1	Element dachowy A/A, ukośny	186 x 49 x 4 cm
Stojak narożny		
3	Stojak narożny 90° z multiklipem	193 x 6 x 6 cm
1	Narożnik 45° obok drzwi z multiklipem	202 x 7,8 x 4 cm
1	Narożnik 45° obok drzwi z wpustem	202 x 7,8 x 4 cm
1	Stojak na element szklany 8 mm, z wpustem i multiklipem	202 x 4,5 x 4 cm
Listwy nakładane		
1	Listwa podporowa dachu	197 x 4 x 4 cm
1	Listwa podporowa dachu	193 x 4 x 4 cm
2	Listwy podporowe dachu 1 x 45°	141,6 x 4 x 4 cm
1	Listwa podporowa dachu 2 x 45°	89,7 x 4 x 4 cm
1	Listwa osłonowa dachu	196 x 1,2 x 4 cm
1	Listwa osłonowa dachu	192 x 1,2 x 4 cm
2	Listwy osłonowe dachu 1 x 22,5°	141,2 x 1,2 x 4 cm
1	Listwa osłonowa dachu 1 x 22,5°	83,2 x 1,2 x 4 cm
1	Listwa podporowa ławki 1 x 45°	142,3 x 4 x 4 cm
1	Listwa podporowa ławki	120 x 4 x 4 cm
3	Listy nakładane na ławkę	58 x 4 x 4 cm
2	Listwy montażowe do osłony ławki	26 x 4 x 4 cm

Ilość	Nazwa	Wymiar
Urządzenie wnętrza		
2	Ławki	195 x 62 x 9 cm
1	Ławka	133,5 x 62 x 9 cm
1	Listwa osłonowa ławki	72,3 x 14 x 2 cm
2	Tylne oparcia	186 x 26 x 5 cm
1	Osłona ławki	195 x 35 x 5 cm
1	Krata ochronna pieca, 3-częściowa 1 x 57 x 75 cm, 2x 45,5 x 55 cm	57 x 475 x 75 cm
1	Kratka podłogowa	70 x 53 x 4 cm
2	Zagłówki	43 x 25 x 7 cm
1	Krata ochronna lampy	38 x 32 x 4 cm
1	Zasuwka do wentylacji	52 x 14 x 1,5 cm
Elementy szklane		
1	Drzwi szklane	191,5 x 68 x 0,8 cm
1	Element szklany	194,5 x 75,5 x 0,8 cm
Listwy gzymsu		
2	Listwy gzymsu 1 x 22,5°	149,8 x 6 x 4 cm
1	Listwa gzymsu 1 x 22,5°	86,5 x 6 x 4 cm
Akcesoria		
1	Profil aluminiowy U	72,3 x 1,2 x 1,5 cm
1	Uchwyt drzwiowy – zestaw drewno/Niro	
1	2 zawiasy drzwiowe 8653-02	
1	Magnes drzwiowy, blacha nakładana z góry	
1	Lampa do sauny	
1	3 mb Przewód silikonowy 5 x 2,5 mm ²	
1	3 mb Przewód silikonowy 3 x 1,5 mm ²	
1	Szablon do montażu multiklipa	
1	Zestaw materiałów montażowych	
1	Instrukcja montażu	

2. Montaż kabiny

Kabina może zostać zamontowana „na lewą stronę” lub „na prawą stronę”. Należy wykorzystać w tym celu rzuty – strona 32 lub strona 33.

2.1. Montaż ramy podłogowej



Wiertło 3 mm, śruby 4 x 70 mm – 3 szt.

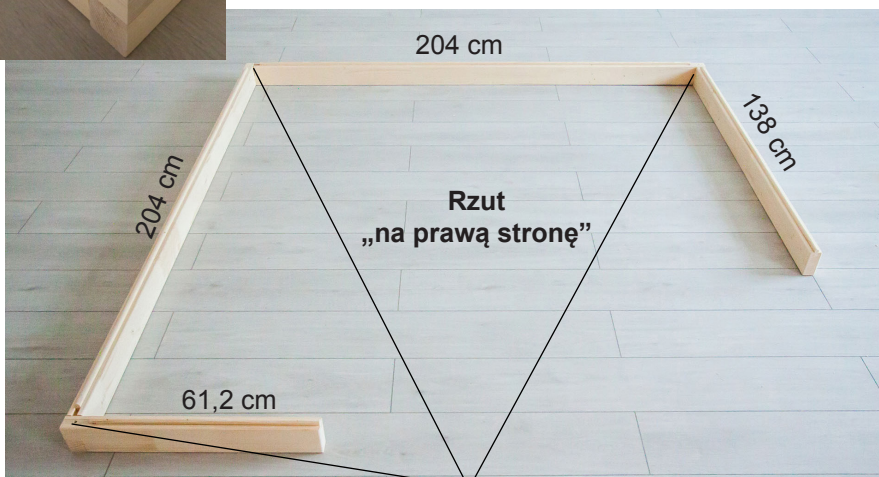
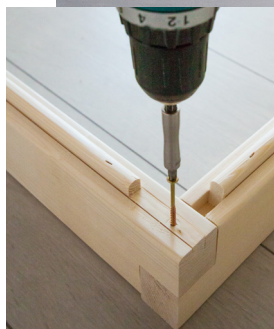

Wiertło 3 mm, śruby 4 x 70 mm – 3 szt.

2.2. Montaż elementów ściennych

Stojaki narożne są łączone za pomocą „multiklipów” z elementami ściennymi. Pozostałe elementy ścienne są łączone na pióro i wpust i są połączone śrubami.



A wskazuje zawsze na stronę widoczną, jest ona oznaczana na górze elementów ściennych.

Uwaga!

Poniżej opisano montaż dla rzutu „na lewą stronę”. Różnice obowiązujące w przypadku montażu wg rzutu „na prawą stronę” – patrz strona 33.

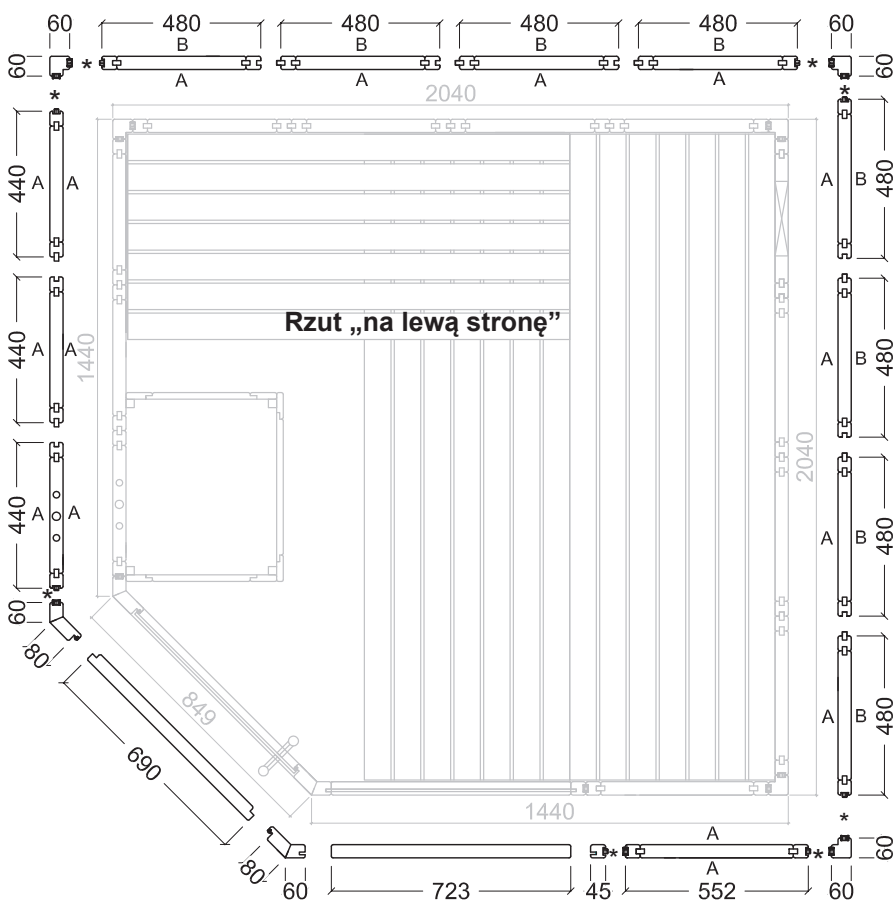

* Multiklips

Montaż narożnika z elementem ściennym

Zamontuj elementy ścienne ze stojakami narożnymi na podłodze, a następnie umieść te stojaki na ramie podłogi.

Nasuń stojak narożny z góry na dół na elementy ścienne. Upewnij się, że multiklipsy są poprawnie ustawione (zob. poniżej). Stojak narożny musi znajdować się w jednej płaszczyźnie z elementami ściennymi.

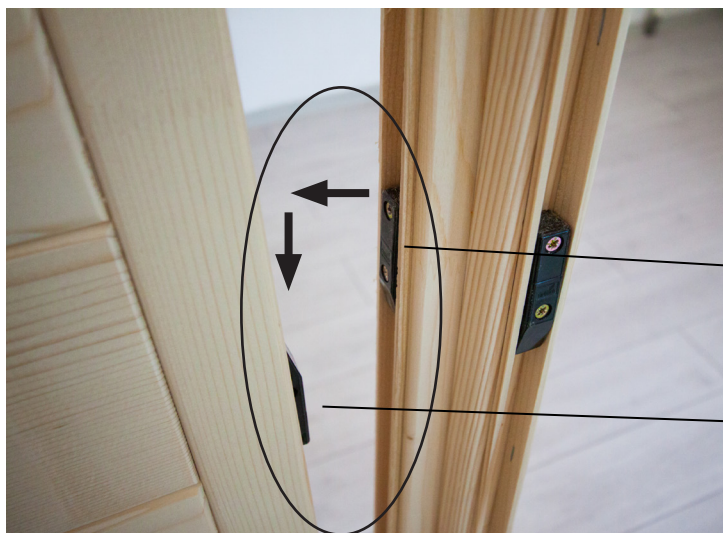

Multiklip



Montaż elementów ściennych

Element elektryczny ma otwory do układania przewodów. Sprawdź położenie na rzutach – patrz strona 32 i strona 33.



Element elektryczny

Łączenie śrubami elementów ściennych



Sprawdź kąt prosty przed połączeniem elementów ściennych śrubami. Postępuj zgodnie ze wskazówką na stronie 4.



Wiertło 3 mm, śruby 4 x 70 mm – 8 szt.

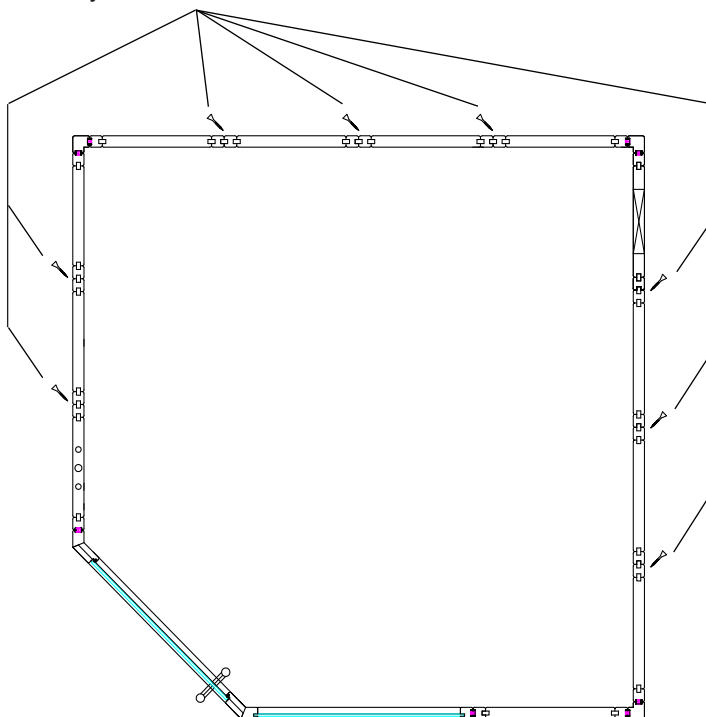

Stojak narożny i stojak na szkło

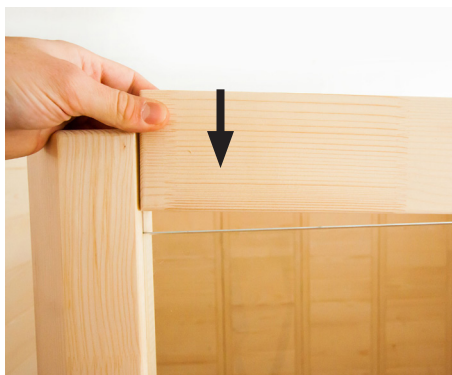
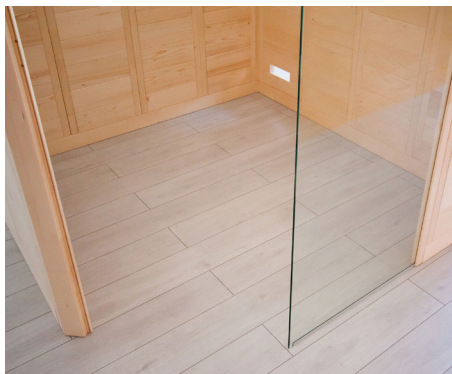

Element szklany

Wiertło 3 mm,
śruba 4 x 70 mm – 1 szt.



Wiertło 3 mm,
śruba 4 x 70 mm – 1 szt.

Element powyżej drzwi

Wiertło 3 mm,
śruba 4 x 70 mm – 1 szt.



Wiertło 3 mm,
śruba 4 x 70 mm – 1 szt.

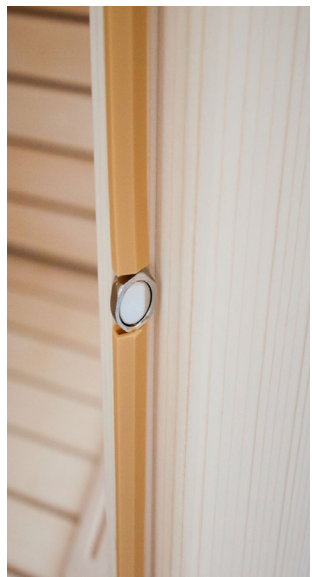
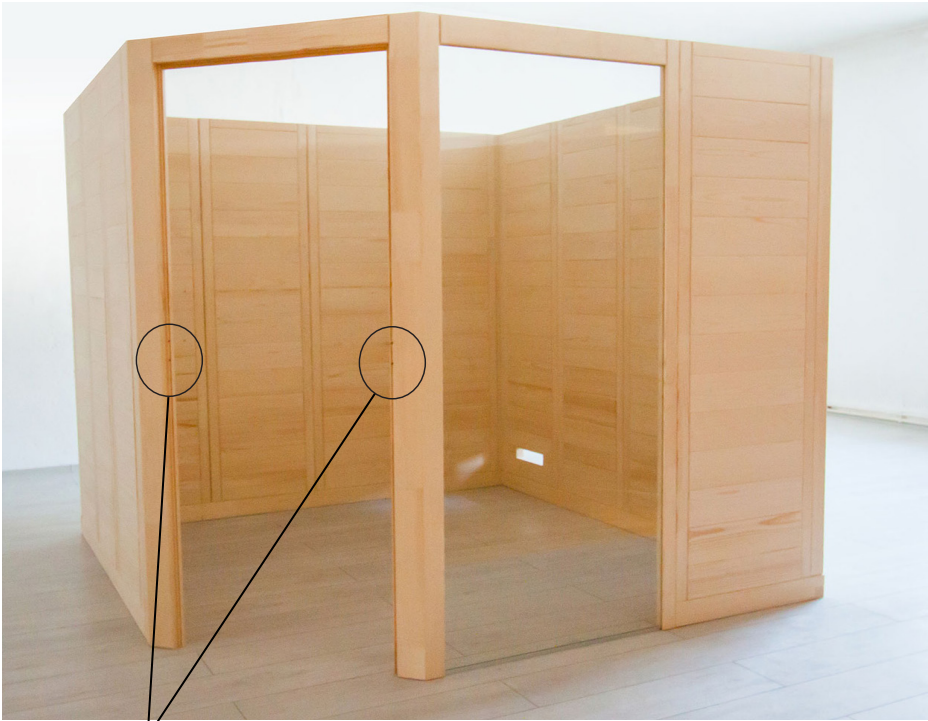

2.3. Montaż dachu

Listwy na dachu



Śrubki 4 x 70 mm



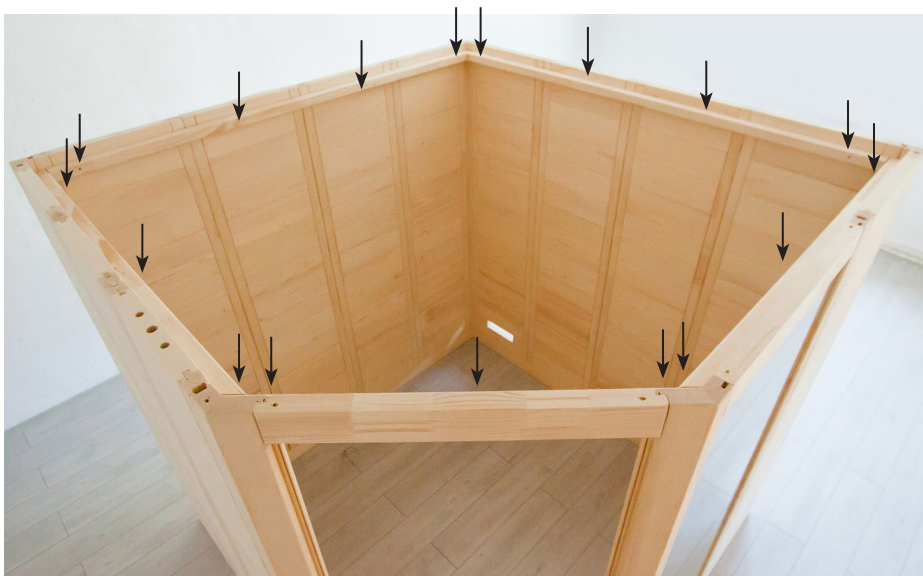

Śruby 4 x 70 mm – 17 szt.

Elementy dachowe

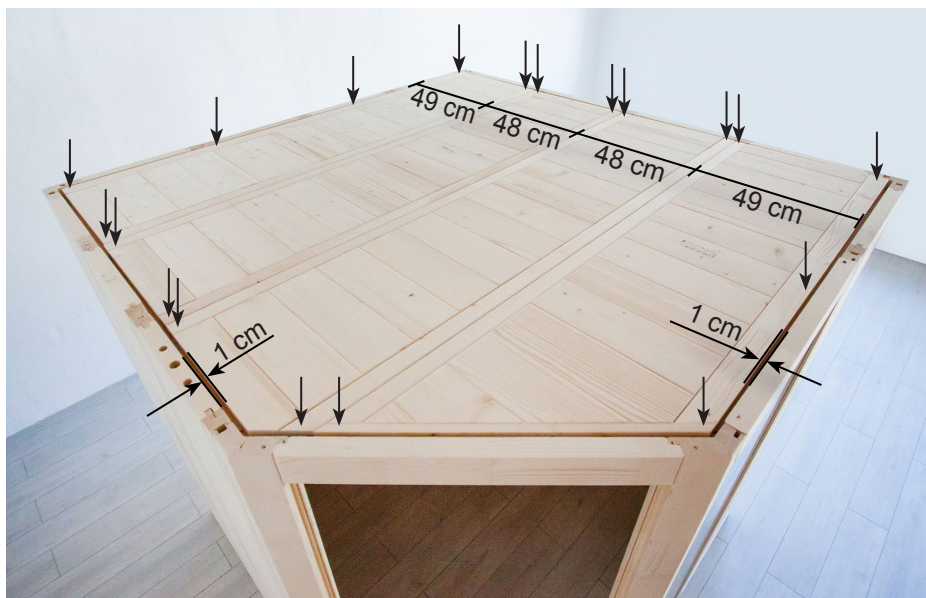

Wiertło 3 mm, śruby 4 x 70 mm – 19 szt.

2.4. Montaż zasuwki do wentylacji



Wiertło 3 mm, śruby 3 x 40 mm – 4 szt.

2.5. Montaż urządzenia wnętrza

Listy nakładane na ławkę

Wiertło 3 mm, śruby 5 x 70 mm – 3 szt.



Śruby 4 x 60 mm – 2 szt.

Wiertło 3 mm, śruby 5 x 70 mm – 3 szt.

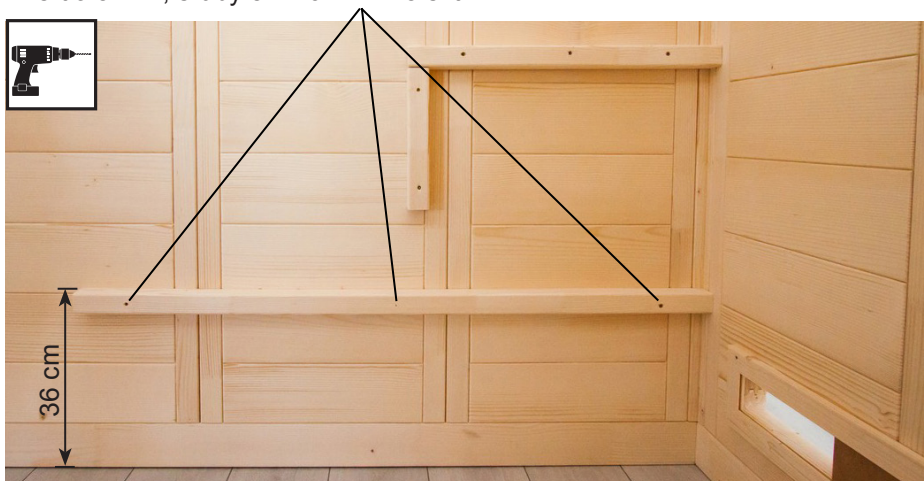

Wiertło 3 mm, śruby 5 x 70 mm – 3 szt.

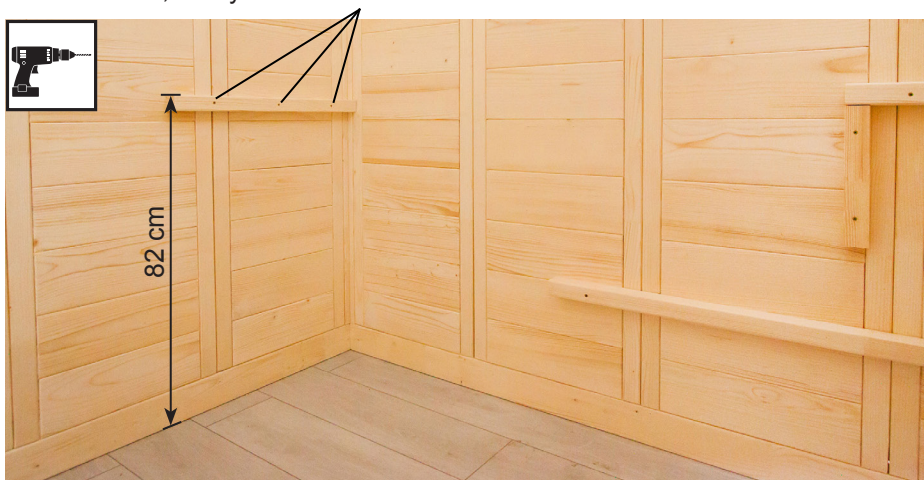

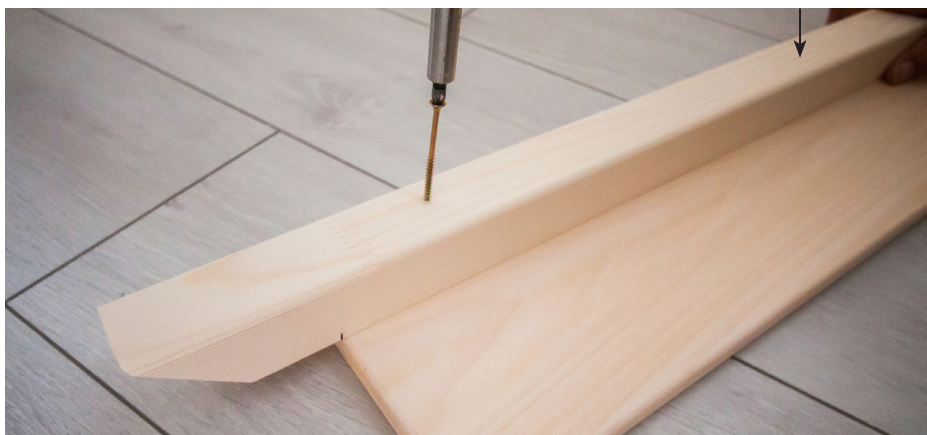
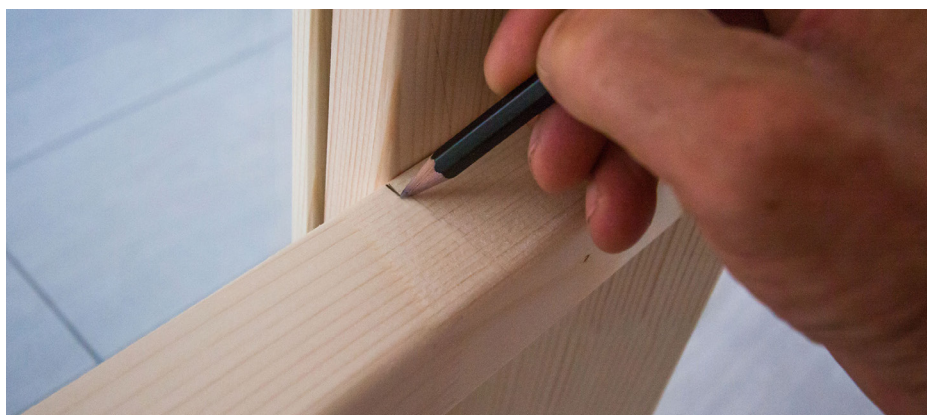
Listwa podporowa ławki z listwą osłonową przed elementem szklanym

Śruby 4 x 60 mm – 2 szt.



Śruby 5 x 70 mm – 3 szt.



Śruby 5 x 70 mm – 3 szt.
Śruby 4 x 60 mm – 2 szt.

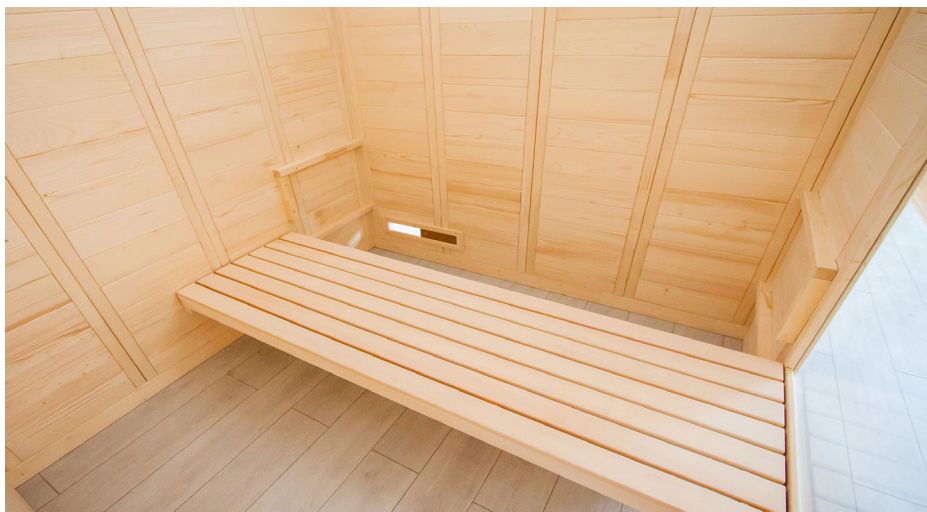

Ośłona ławki

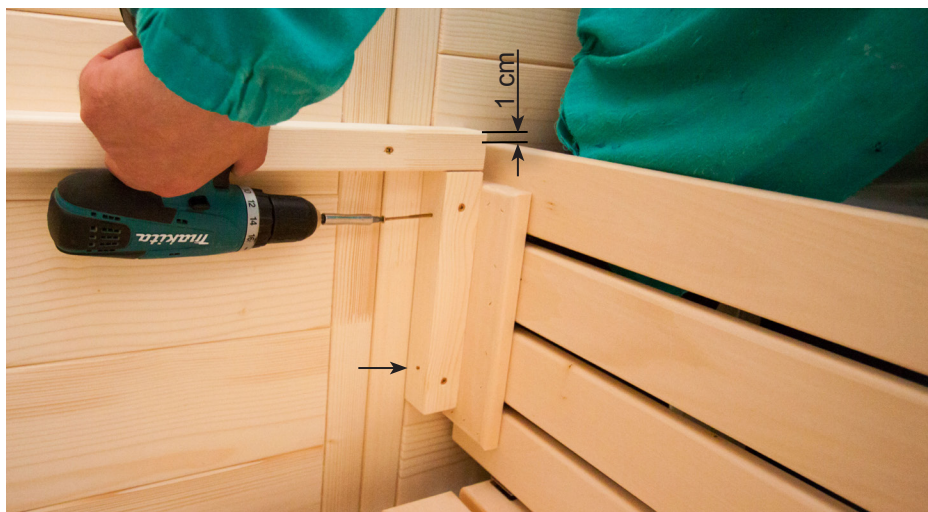

Śruby 4 x 60 mm – 4 szt.

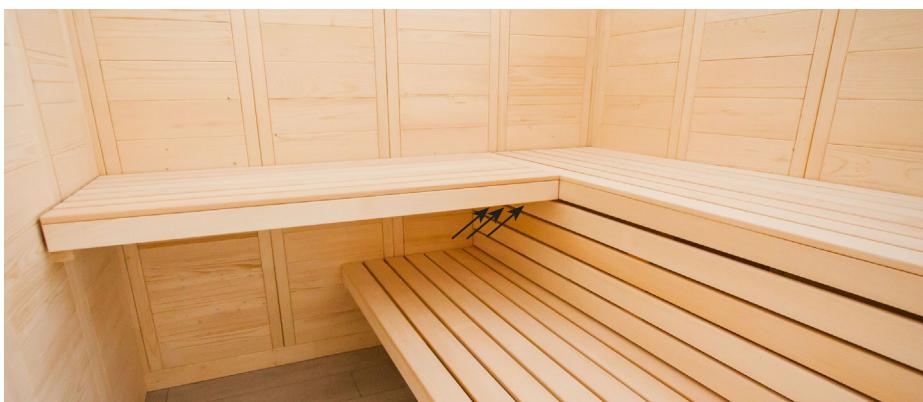
Ławka

Wiertło 3 mm, śruby 5 x 70 mm – 3 szt.

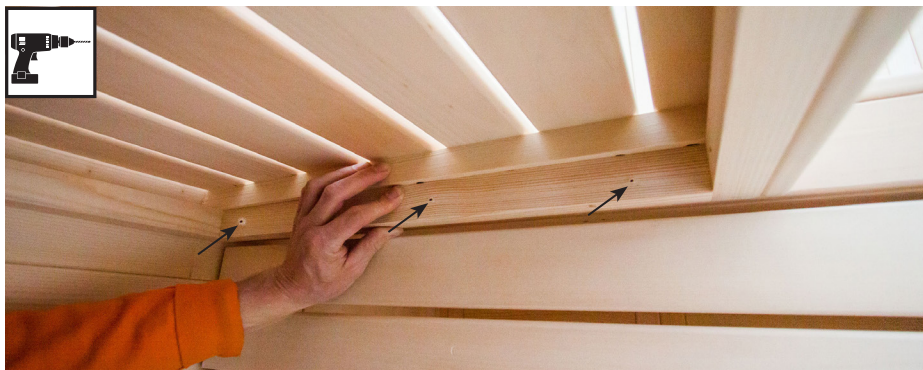

Tylne oparcie

Wiertło 3 mm, śruby 3 x 40 mm – 6 szt.



2.6. Montaż akcesoriów

Lampa do sauny



Zamontuj lampę
(nie wchodzi w zakres dostawy)



Wiertło 3 mm, śruby – 2 szt.

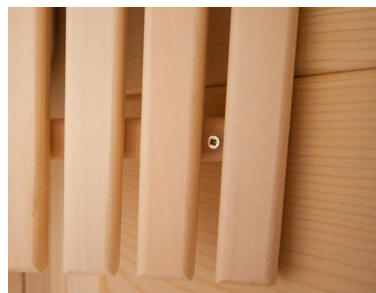
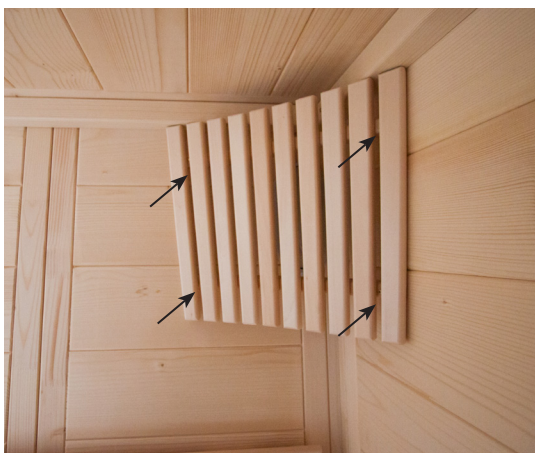

Śruby 3 x 40 mm – 4 szt.

Krata ochronna pieca

Przed montażem kraty ochronnej pieca wywierć w elemencie elektrycznym wylot na przewód pieca.



Śruby 3 x 40 mm – 4 szt.

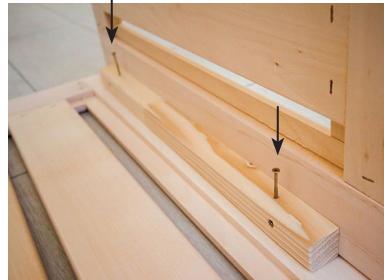

Śruby 3 x 40 mm – 4 szt.



2.7. Montaż drzwi szklanych



Dolny otwór uchwyty drzwiowego znajduje się na wysokości 92,4 cm. Ustawienie okuc wykonuje się poprzez wyrównanie/obróć obu wkładek wykonanych z tworzywa sztucznego.

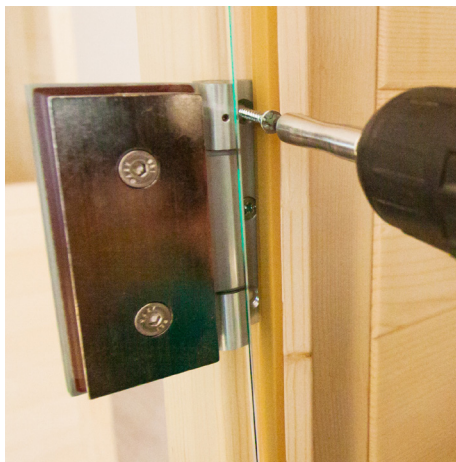
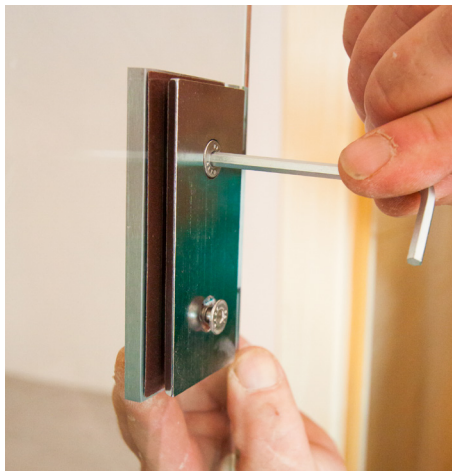
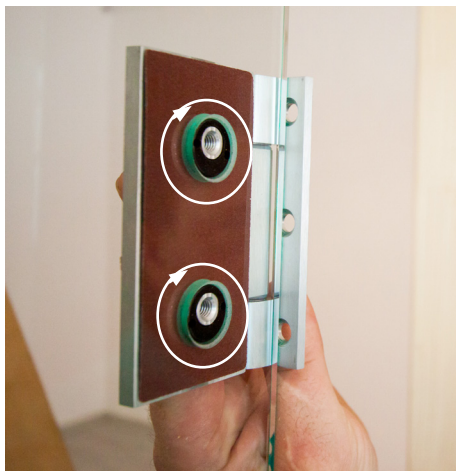

Uchwyt drzwiowy i blacha nakładana z góry

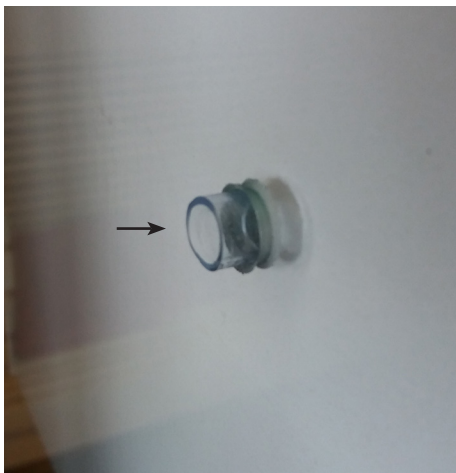

Włóż pierścień silikonowy do otworów



Włóż podkładkę z tworzywa sztucznego do uchwytu Niro



2.8. Montaż gzymsu



Zamontuj gzyms dopiero po przeprowadzeniu przewodu do pieca sauny i jednostki sterującej do sauny. Może konieczne być wykonania wycięcia w listwie przy elemencie elektrycznym.

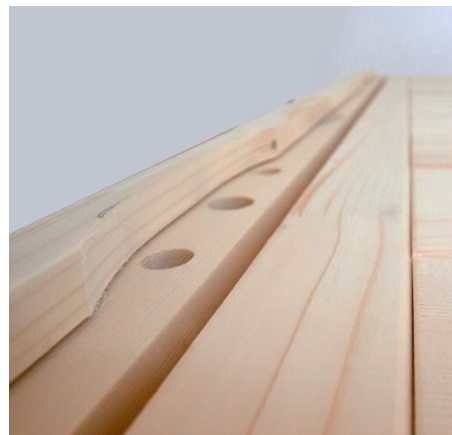
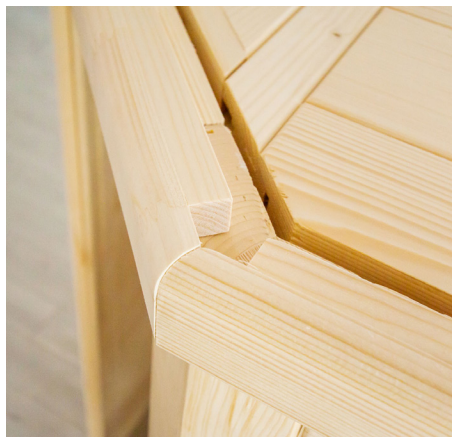
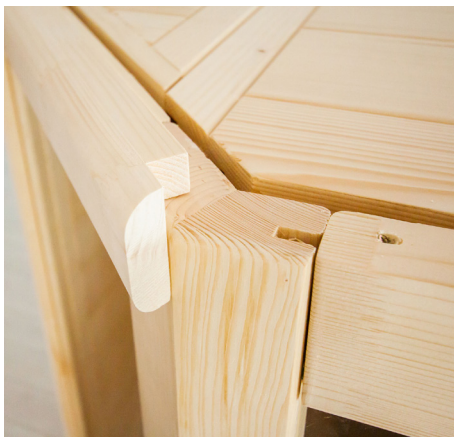

Wiertło 3 mm, śruby 3 x 40 mm – 9 szt.

2.9. Montaż listwy osłonowej dachu



Zamontuj listwę osłonową dachu dopiero po przeprowadzeniu przewodu do pieca sauny i jednostki sterującej do sauny. Może konieczne być wykonania wycięcia w listwie przy elemencie elektrycznym.



Śruby 3 x 40 mm – 14 szt.

3. Rzut

3.1. Rzut „na lewą stronę”

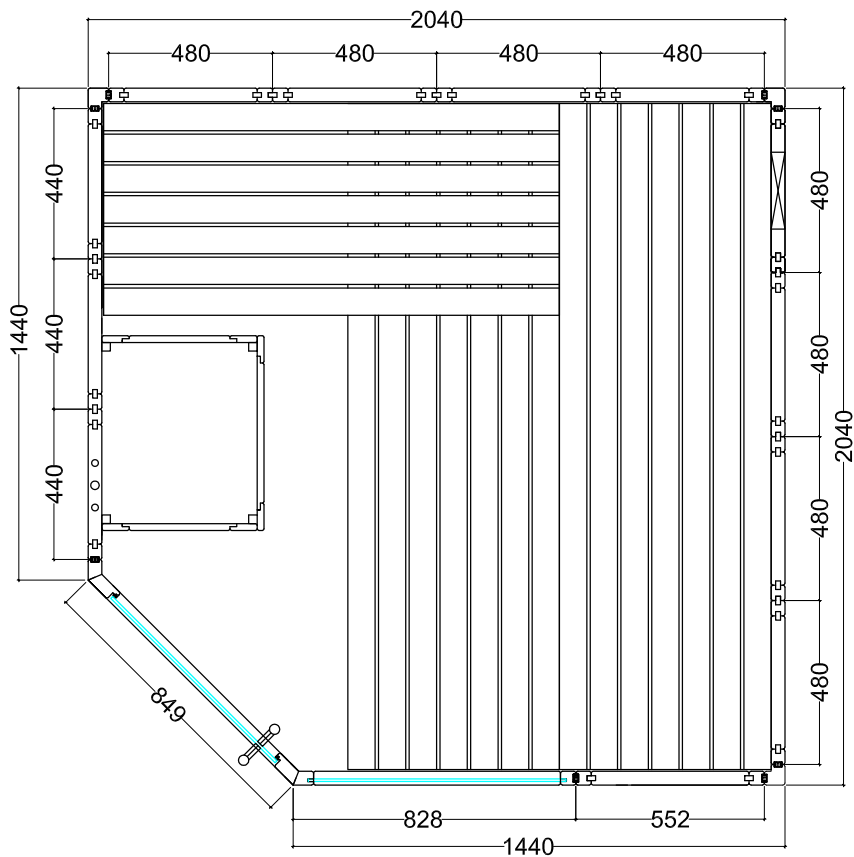

3.2. Rzut „na prawą stronę”

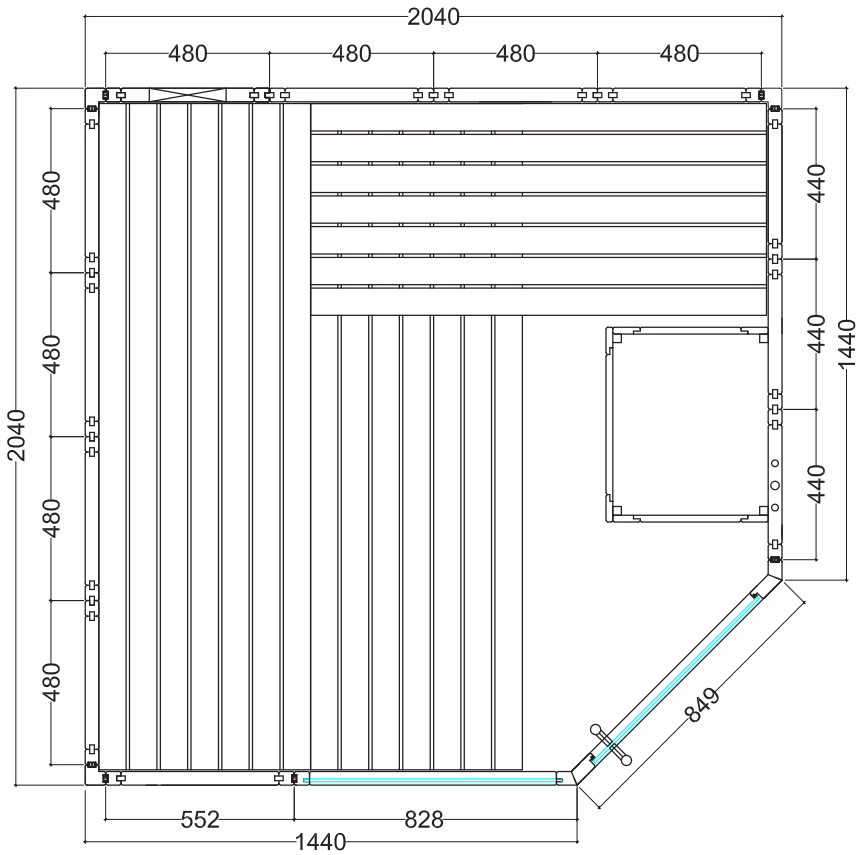

3.3. Różnice obowiązujące w przypadku montażu wg rzutu „na prawą stronę”

W przypadku montażu stojaka narożnego i stojaka na szkło (strona 13)

Usuń multiklipsy ze stojaka narożnego i stojaka na szkło.

Użyj dołączonego szablonu do nowego ustawienia multiklipów.

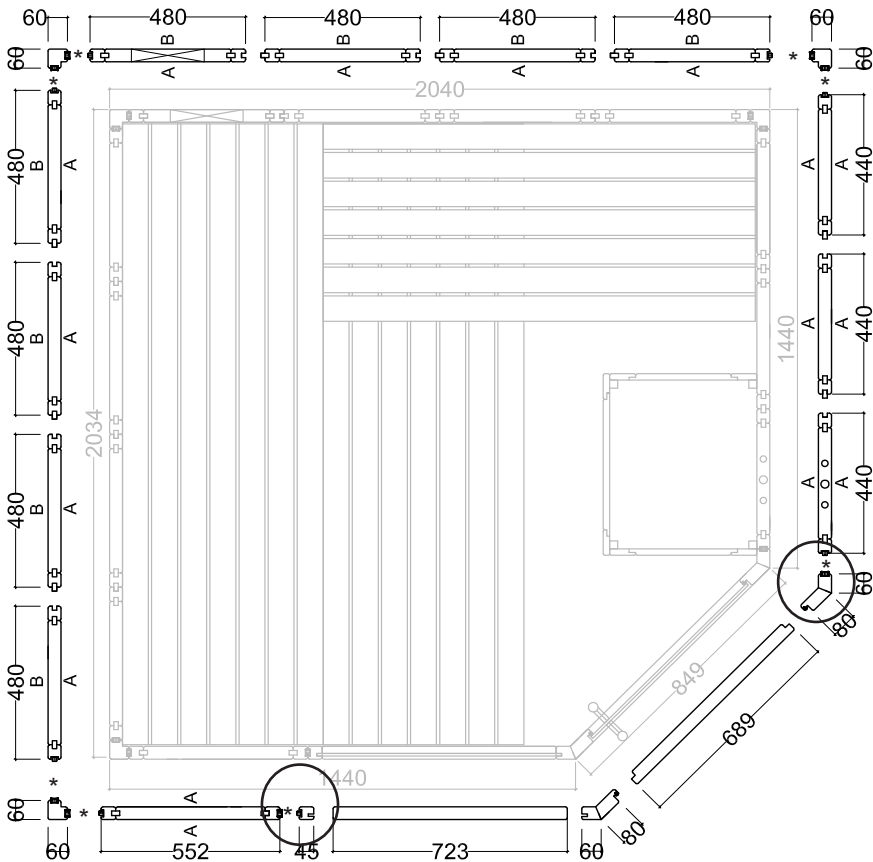

* Multiklips





sentiotec GmbH | Division of Harvia Group | Oberregauer Straße 48, A-4844 Regau
T +43 (0) 7672/277 20-567 | F -801 | info@sentiotec.com | www.sentiotec.com

Sauna maciça

ALASKA

CORNER

206 x 206 x 204 cm

MANUAL DE MONTAGEM
Português

PT



Índice

1. Preparação para a montagem	3
1.1. Ferramentas necessárias	4
1.2. Manutenção e limpeza	5
1.3. Eliminação	5
1.4. Lista de peças da ALASKA CORNER	6
2. Montagem da cabina	8
2.1. Montagem da armação do chão	8
2.2. Montagem dos elementos de parede	9
2.3. Montagem do teto	17
2.4. Montagem da corredeira de ventilação	19
2.5. Montagem do equipamento interior	19
2.6. Montagem dos acessórios	26
2.7. Montagem da porta de vidro	28
2.8. Montagem do friso do teto	30
2.9. Montagem da barra de cobertura do teto	31
3. Plano	32
3.1. Plano “à esquerda”	32
3.2. Plano “à direita”	33
3.3. Alterações na montagem do plano “à direita”	34

1. Preparação para a montagem

Leia atentamente o manual de montagem e guarde-o nas proximidades da sauna. Poderá, assim, ler as informações sobre o produto a qualquer momento posteriormente.



Este manual de montagem também está disponível na área de downloads da nossa página web em www.sentiotec.com/downloads.

Indicações importantes:

- Antes de começar a trabalhar, verifique, com base na lista de peças, se todas as peças individuais foram efetivamente fornecidas. Se, excepcionalmente, faltarem peças individuais, informe o seu distribuidor num período máximo de 14 dias após a receção da cabina.
- O espaço em que a cabina da sauna é montada tem de ser seco e garantir uma circulação de ar adequada.
- O piso tem de ser horizontal e plano, de preferência um pavimento em mosaico ou pedra.
- Para os trabalhos de montagem da cabina é necessária uma altura mínima de 230 cm.
- Manter impreterivelmente uma distância mínima de 5 cm em relação à parede.
- As peças em madeira a utilizar no interior não podem ser tratadas com agentes impregnantes.
- Para a montagem é necessária uma pessoa auxiliar.
- A madeira é um produto natural que, apesar de um bom armazenamento, pode dilatar, encolher ou sofrer deformações. Por isso, é possível que seja necessário exercer um pouco de força durante a montagem.
- Todos os aparafusamentos têm de ser perfurados previamente.

Atenção!

A ligação elétrica só pode ser executada por um electricista ou por uma pessoa com formação equivalente.

1.1. Ferramentas necessárias

- Martelo e madeira suplementar ou um martelo de borracha
- Aparafusadora sem fios com pontas para parafusos em cruz e Torx
- Rolo de fita métrica
- Brocas com um diâmetro de 3 mm, 10 mm, 20 - 30 mm (para o cabo de alimentação do aquecedor de sauna)
- Nível de bolha de ar
- Chave de sextavado interior de 1,5 mm
- Faca universal
- Escadote
- Serrote



Este símbolo identifica dicas e indicações úteis



Perfuração prévia



Corte à medida com serrote



Verificação do ângulo direito:

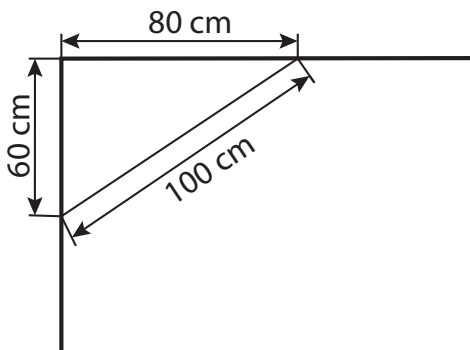

1.2. Manutenção e limpeza

- A sauna deverá ser limpa com um pano húmido. Utilize apenas água quente. Não utilize qualquer produto de limpeza.
- Se a sauna não for utilizada por um longo período, recomendamos que aqueça a cabina uma vez por mês.



As cavidades com resina não são qualquer motivo de reclamação, uma vez que estas surgem de forma recorrente na madeira de abeto e não é possível detetar, no momento da separação, a profundidade a que se encontram.

Quando estas se encontram pouco abaixo da superfície, emergem com a formação de calor e começam a “sangrar”.

Remover as fugas de resina com um pano embebido em acetona. Se surgirem apenas gotas de resina, deixe-as secar e, depois, raspe-as cuidadosamente com uma faca.

PT

1.3. Eliminação



- Elimine os materiais da embalagem de acordo com as diretivas de eliminação em vigor.
- Os aparelhos usados contêm materiais reutilizáveis, mas também substâncias perigosas. Por isso, não deite, sob circunstância alguma, o seu aparelho usado no lixo residual. Elimine-o, sim, de acordo com as disposições válidas localmente.

1.4. Lista de peças da ALASKA CORNER

Quant.	Designação	Medida
Armação do chão		
2	Armação do chão	204 x 9 x 4 cm
1	Armação do chão	138 x 9 x 4 cm
1	Armação do chão	61,2 x 9 x 4 cm
Elementos de parede		
4	Elementos de parede A/B	193 x 48 x 4 cm
3	Elementos de parede A/B com multiclipe	193 x 48 x 4 cm
1	Elemento elétrico A/A com multiclipe	193 x 44 x 4 cm
1	Elemento de ventilação A/B com multiclipe	193 x 48 x 4 cm
1	Elemento de parede A/A com multiclipe	193 x 44 x 4 cm
1	Elemento de parede A/B	193 x 44 x 4 cm
1	Elemento de parede A/A com multiclipe	193 x 55,2 x 4 cm
1	Elemento acima da porta	69,3 x 10,1 x 4 cm
1	Elemento acima do elemento de vidro	72,3 x 8,6 x 4 cm
Elementos do teto		
2	Elementos de teto A/B	194 x 48 x 4 cm
1	Elemento de teto A/B	194 x 49 x 4 cm
1	Elemento de teto A/A inclinado	186 x 49 x 4 cm
Suportes de canto		
3	Suporte de canto 90° com multiclipe	193 x 6 x 6 cm
1	Suporte de canto 45° junto à porta com multiclipe	202 x 7,8 x 4 cm
1	Suporte de canto 45° junto à porta com ranhura	202 x 7,8 x 4 cm
1	Suporte para elemento de vidro, ranhura de 8 mm, com multiclipe	202 x 4,5 x 4 cm
Barras de apoio		
1	Barra de apoio do teto	197 x 4 x 4 cm
1	Barra de apoio do teto	193 x 4 x 4 cm
2	Barras de apoio para o teto 1 x 45°	141,6 x 4 x 4 cm
1	Barra de apoio para o teto 2 x 45°	89,7 x 4 x 4 cm
1	Barra de cobertura do teto	196 x 1,2 x 4 cm
1	Barra de cobertura do teto	192 x 1,2 x 4 cm
2	Barras de cobertura para o teto 1 x 22,5°	141,2 x 1,2 x 4 cm
1	Barra de cobertura para o teto 1 x 22,5°	83,2 x 1,2 x 4 cm
1	Barra de apoio do banco 1 x 45°	142,3 x 4 x 4 cm
1	Barra de apoio do banco	120 x 4 x 4 cm
3	Barras de apoio para o banco	58 x 4 x 4 cm
2	Barras de montagem para o anteparo do banco	26 x 4 x 4 cm

Quant.	Designação	Medida
Equipamento interior		
2	Bancos	195 x 62 x 9 cm
1	Banco	133,5 x 62 x 9 cm
1	Barra de cobertura do banco	72,3 x 14 x 2 cm
2	Encostos	186 x 26 x 5 cm
1	Resguardo do banco	195 x 35 x 5 cm
1	Grelha de proteção do aquecedor 3 unid. 1 x 57 x 75 cm, 2x 45,5 x 55 cm	57 x 475 x 75 cm
1	Revestimento do chão	70 x 53 x 4 cm
2	Apoios de cabeça	43 x 25 x 7 cm
1	Grelha de proteção da lâmpada	38 x 32 x 4 cm
1	Corrediça de ventilação	52 x 14 x 1,5 cm
Elementos de vidro		
1	Porta de vidro	191,5 x 68 x 0,8 cm
1	Elemento de vidro	194,5 x 75,5 x 0,8 cm
Barras do friso do teto		
2	Barras do friso do teto 1 x 22,5°	149,8 x 6 x 4 cm
1	Barra do friso do teto 1 x 22,5°	86,5 x 6 x 4 cm
Acessórios		
1	Perfil de alumínio em U	72,3 x 1,2 x 1,5 cm
1	Conjunto de puxador da porta em madeira/aço inoxidável	
1	2 dobradiças de porta 8653-02	
1	Íman da porta, chapa de transferência	
1	Luz da sauna	
1	Cabo de silicone 3 m. lin., 5 x 2,5 mm ²	
1	Cabo de silicone 3 m. lin., 3 x 1,5 mm ²	
1	Molde para a montagem dos multiclipês	
1	Conjunto de material de montagem	
1	Manual de montagem	

2. Montagem da cabina

A cabina pode ser montada “à esquerda” ou “à direita”. A este respeito, tenha em atenção os planos nas páginas 32 e 33.

2.1. Montagem da armação do chão

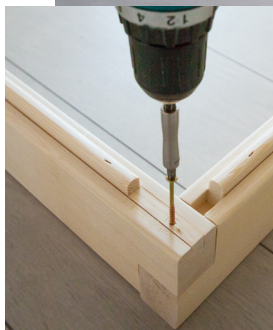

Broca de 3 mm, 3 parafusos de 4 x 70 mm

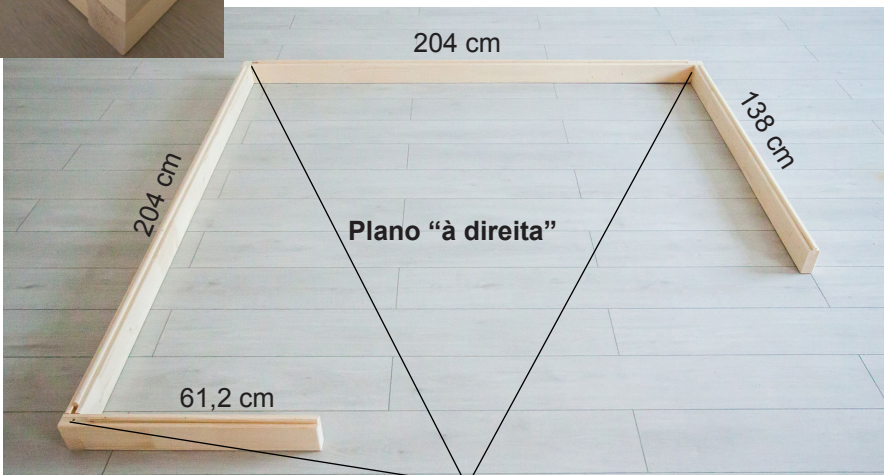

Broca de 3 mm, 3 parafusos de 4 x 70 mm

2.2. Montagem dos elementos de parede

Os suportes de canto são ligados aos elementos de parede através de “multiclipes”. Os outros elementos de parede são ligados por meio de ranhuras e molas e aparafusados uns aos outros.



A designa sempre o lado visível. Este está identificado na parte superior dos elementos de parede.

Atenção!

De seguida, é descrita a montagem para o plano “à esquerda”. Para alterações relativas à montagem para o plano “à direita” – consulte página 33.

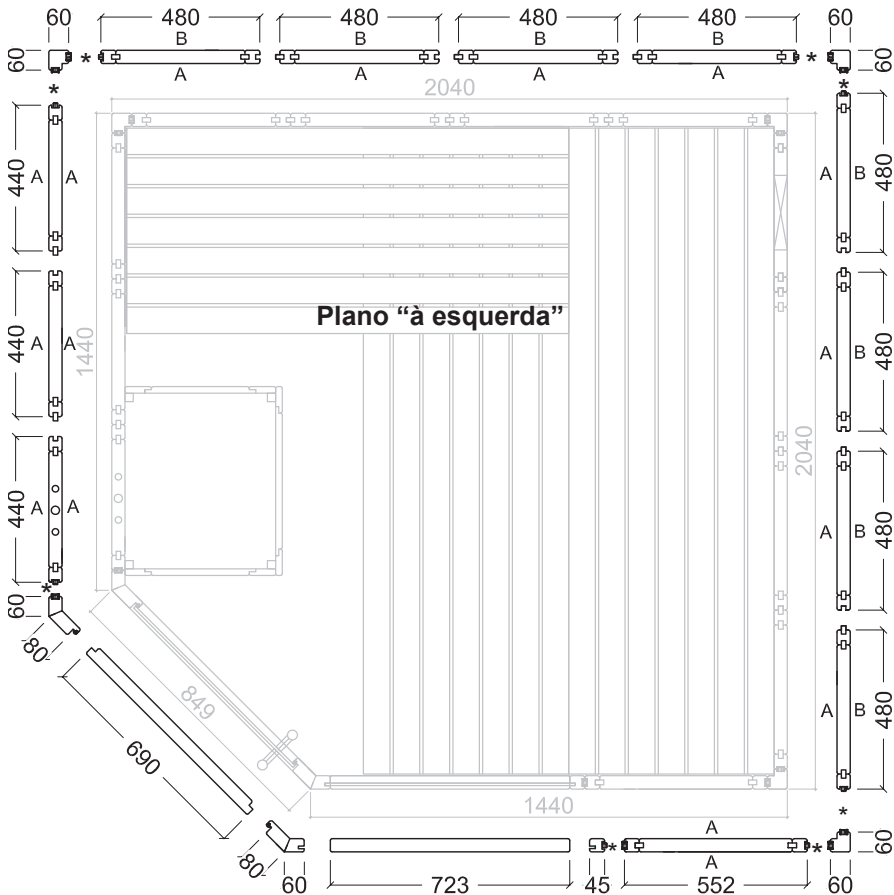

* Multiclipes

Montagem dos suportes de canto com os elementos de parede

Monte previamente os elementos de parede com os suportes de canto no chão e coloque depois esses cantos sobre a armação do chão.

Insira o suporte de canto nos elementos de parede, de cima para baixo. Ao fazê-lo, tenha em atenção o alinhamento correto dos “multiclipes” (ver em baixo). O suporte de canto tem de ficar alinhado com os elementos de parede.

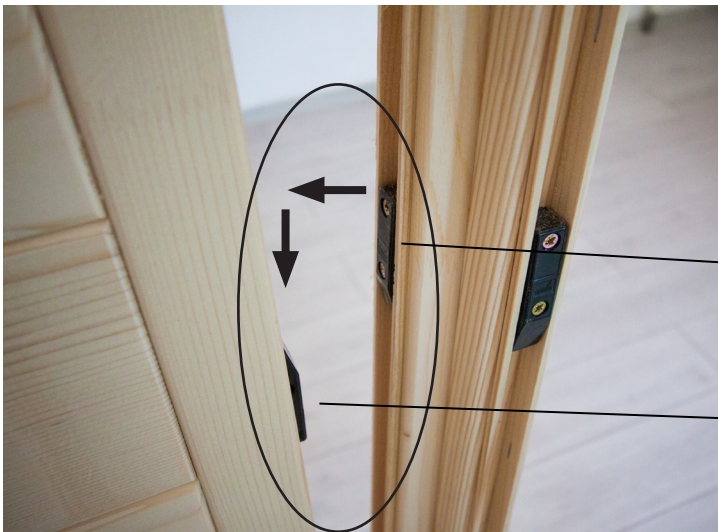

Multiclipe

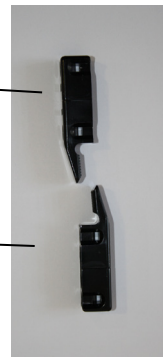

Montagem dos elementos de parede

O elemento elétrico dispõe de orifícios para passar os cabos.
Consulte a posição nos planos, nas páginas 32 e 33.



PT



Elemento elétrico

Aparafusamento dos elementos de parede

Verifique os ângulos direitos antes de aparafusar os elementos de parede.
Tenha em atenção a dica na página 4.



Broca de 3 mm, 8 parafusos de 4 x 70 mm

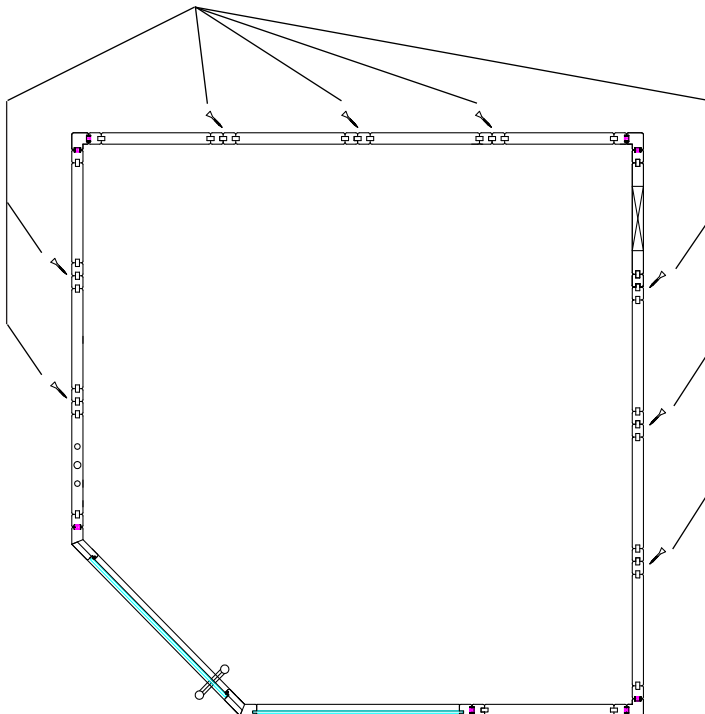

Suportes de canto e suportes para vidro



PT



Elemento de vidro

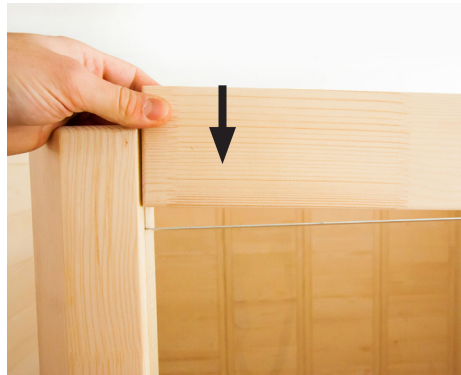

Broca de 3 mm,
1 parafuso de 4 x 70 mm



Broca de 3 mm,
1 parafuso de 4 x 70 mm

Elemento por cima da porta

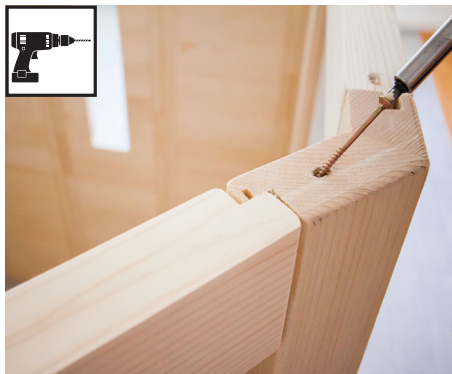

PT

Broca de 3 mm,
1 parafuso de 4 x 70 mm



Broca de 3 mm,
1 parafuso de 4 x 70 mm

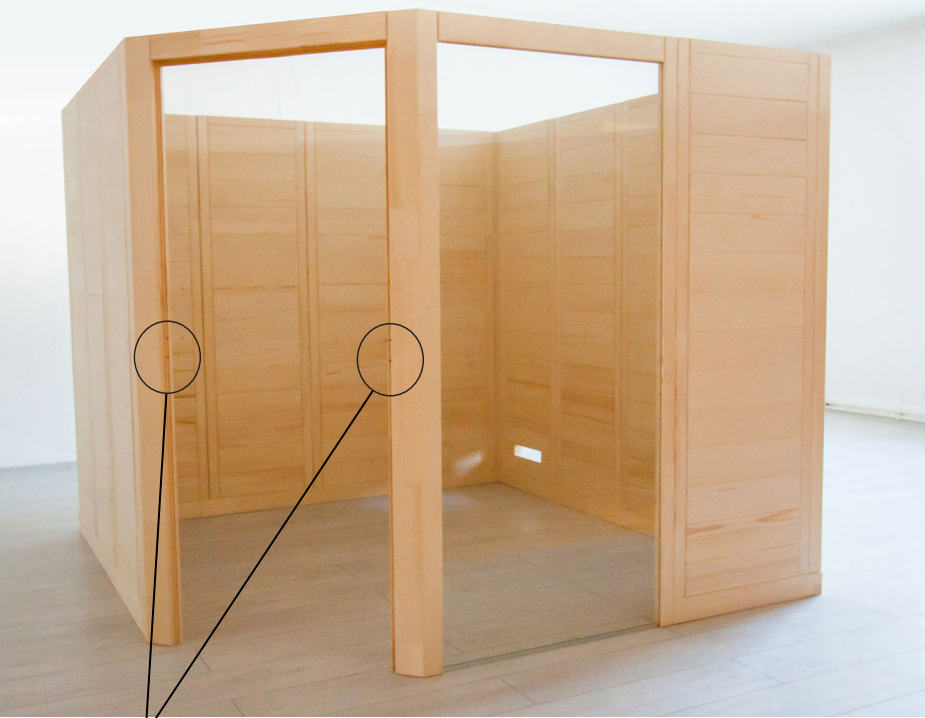

2.3. Montagem do teto

Barras de apoio para o teto



Parafusos de 4 x 70 mm



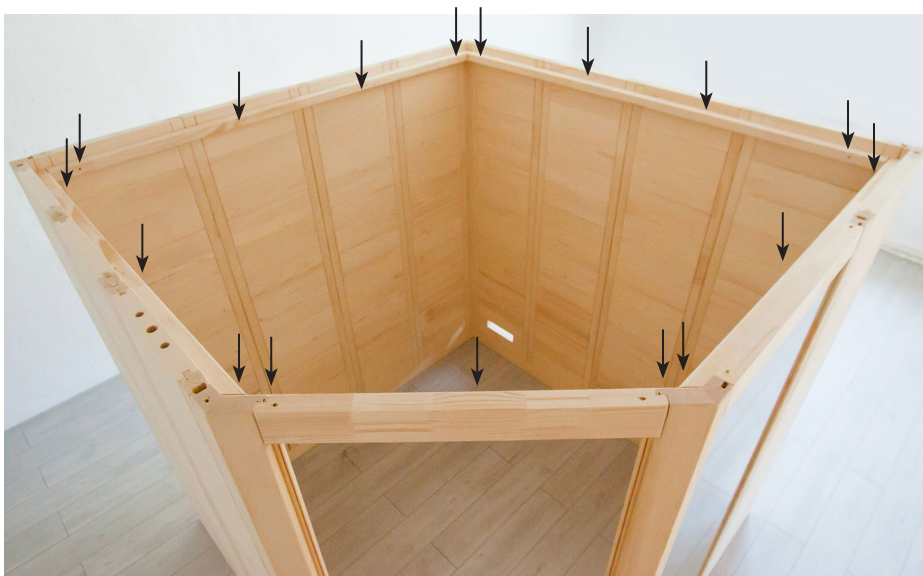

17 parafusos de 4 x 70 mm

Elementos do teto

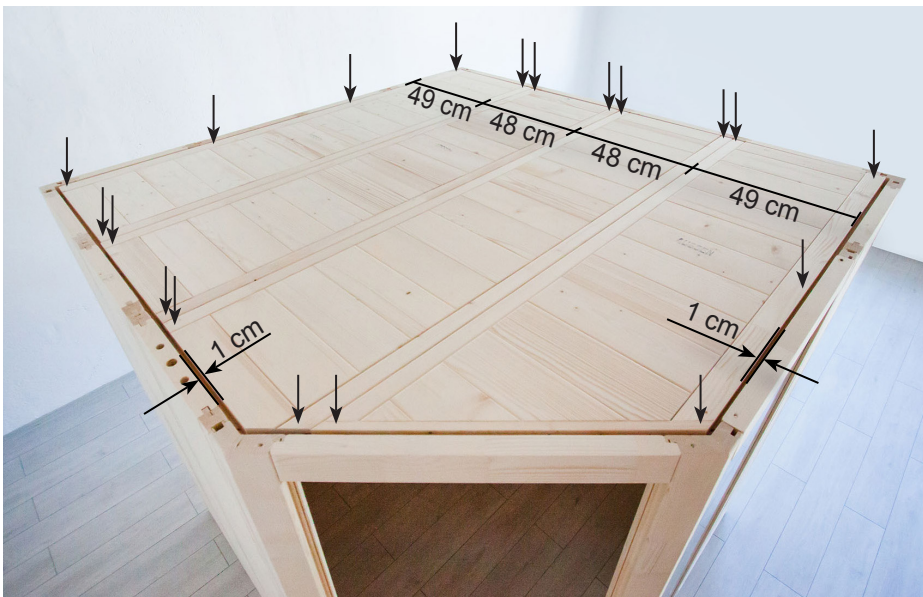

Broca de 3 mm, 19 parafusos de 4 x 70 mm

2.4. Montagem da corrediça de ventilação



PT

Broca de 3 mm, 4 parafusos de 3 x 40 mm

2.5. Montagem do equipamento interior

Barras de apoio para o banco

Broca de 3 mm, 3 parafusos de 5 x 70 mm



2 parafusos de 4 x 60 mm

Broca de 3 mm, 3 parafusos de 5 x 70 mm

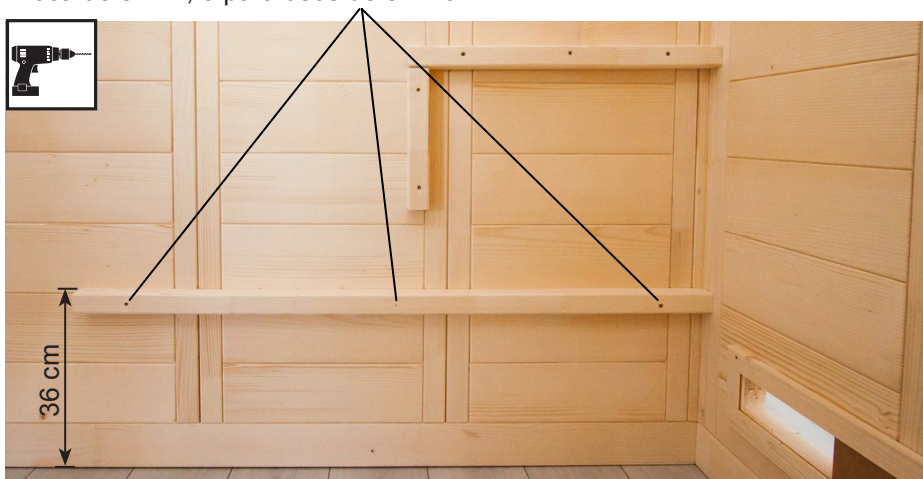

Broca de 3 mm, 3 parafusos de 5 x 70 mm

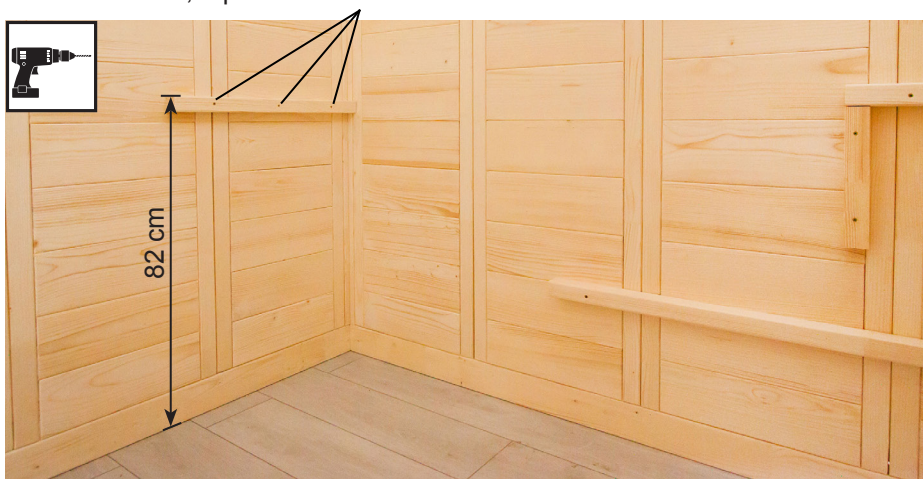

Barra de apoio do banco com antepara da cobertura à frente da peça de vidro

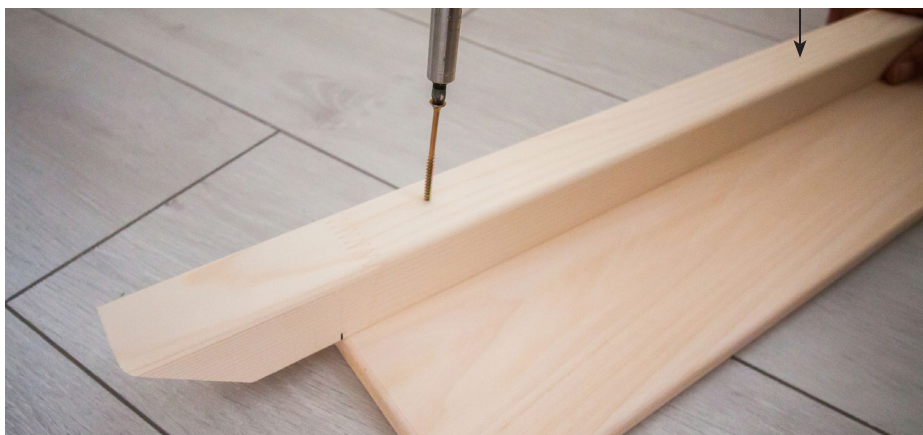
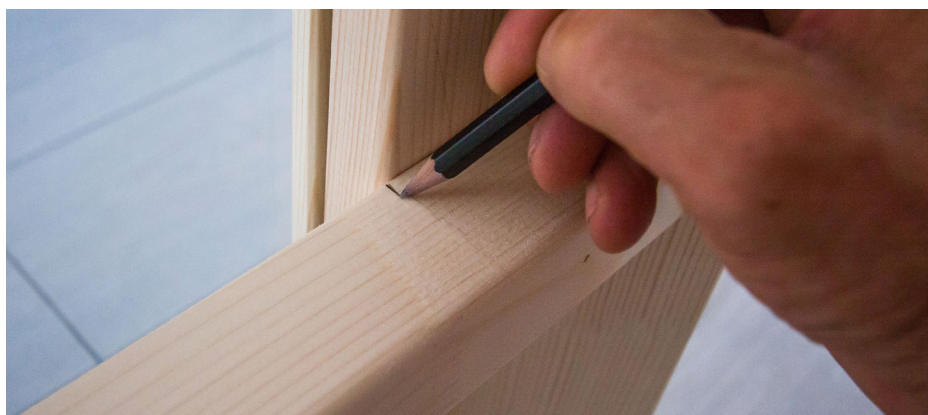

2 parafusos de 4 x 60 mm



3 parafusos de 5 x 70 mm



3 parafusos de 5 x 70 mm
2 parafusos de 4 x 60 mm

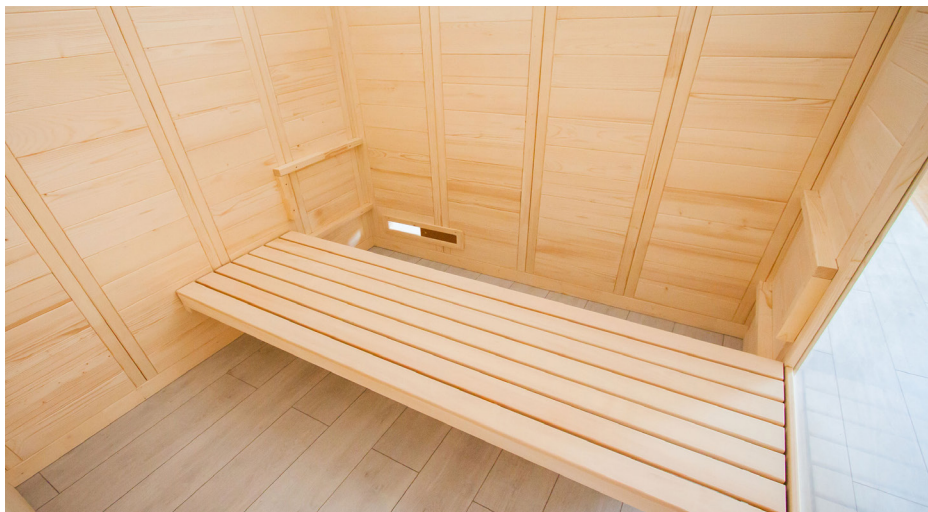

PT

Resguardo do banco

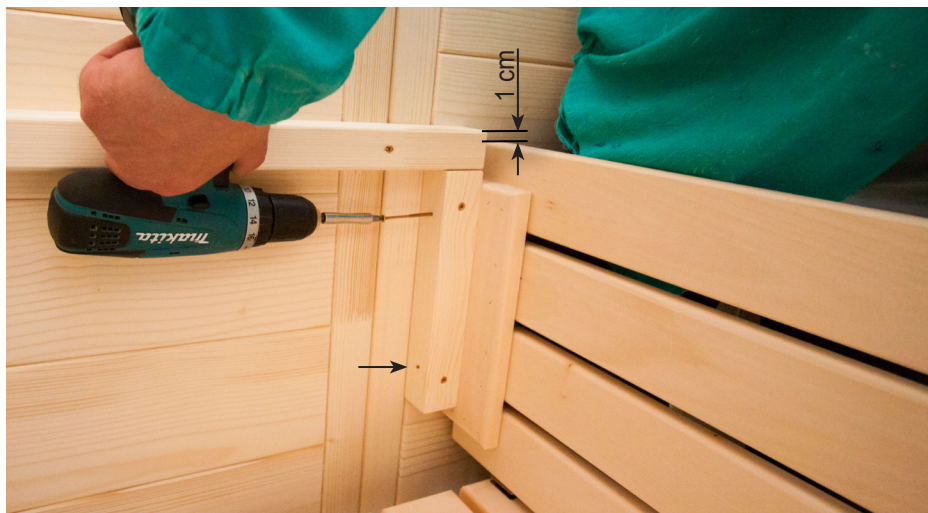

4 parafusos de 4 x 60 mm

Banco

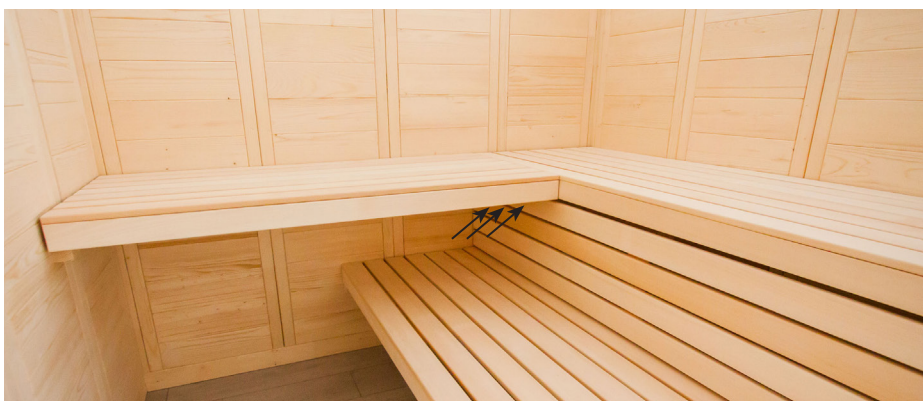

Broca de 3 mm, 3 parafusos de 5 x 70 mm

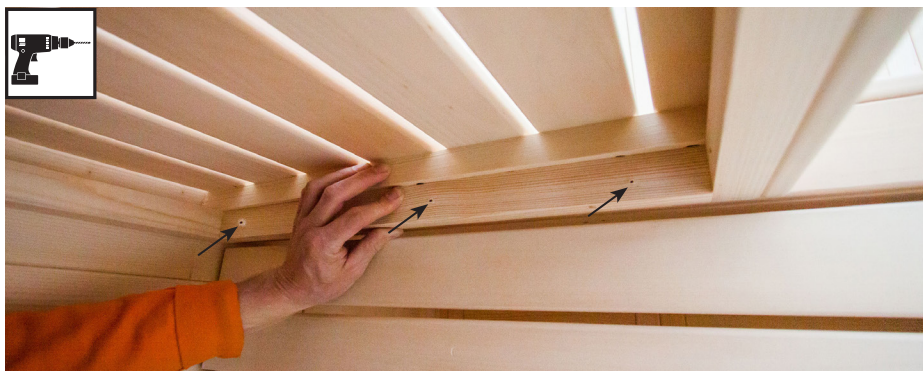

Encosto



Broca de 3 mm, 6 parafusos de 3 x 40 mm

PT



2.6. Montagem dos acessórios

Luz da sauna



Colocar a lâmpada
(não incluída no volume
de fornecimento)



Broca de 3 mm, 2 parafusos

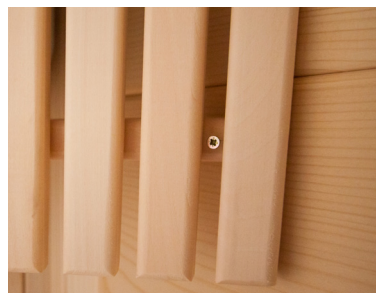

4 parafusos de 3 x 40 mm

Grelha de proteção do aquecedor

Antes de montar a grelha de proteção do aquecedor, faça um furo para a saída do cabo do aquecedor no elemento elétrico.



4 parafusos de 3 x 40 mm

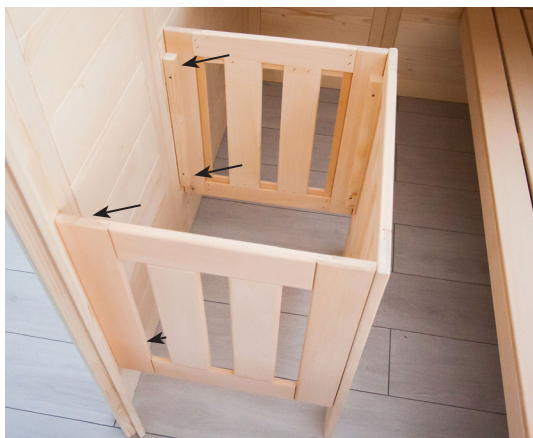
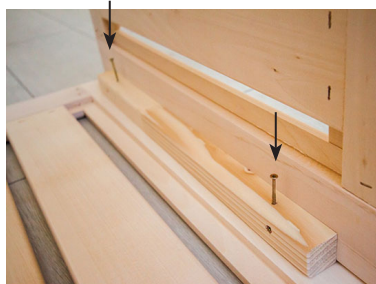

4 parafusos de 3 x 40 mm



2.7. Montagem da porta de vidro



O furo inferior do puxador da porta encontra-se a 92,4 cm de altura. O alinhamento das ferragens é efetuado através do ajuste/rotação de ambas as inserções de plástico.

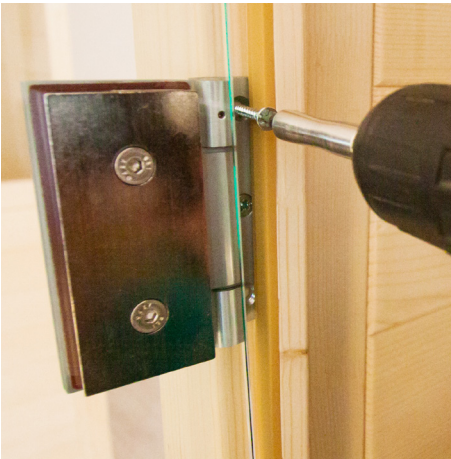
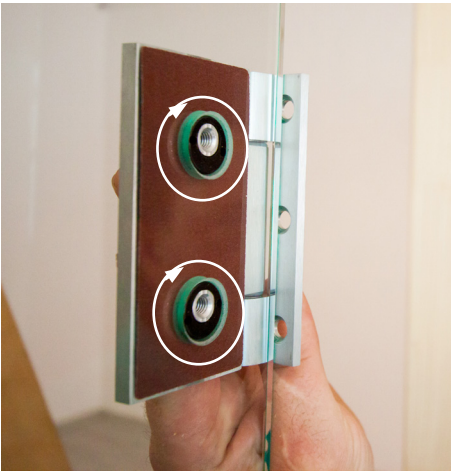

Puxador da porta e chapa de transferência

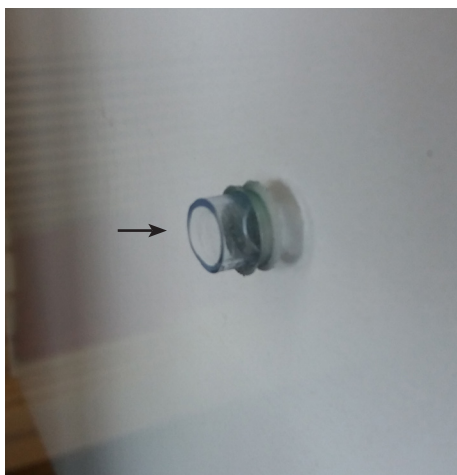

Colocar o anel de silicone nos orifícios



Inserir a anilha plana de plástico no puxador de aço inoxidável



2.8. Montagem do friso do teto



Monte o friso do teto só depois de ter puxado os cabos para o aquecedor da sauna e para o controlo da sauna. A barra poderá ter de ser cortada junto do elemento elétrico.



Broca de 3 mm, 9 parafusos de 3 x 40 mm

2.9. Montagem da barra de cobertura do teto



Monte a barra de cobertura do teto só depois de ter puxado os cabos para o aquecedor da sauna e para o controlo da sauna. A barra poderá ter de ser cortada junto do elemento eléctrico.



PT

14 parafusos de 3 x 40 mm

3. Plano

3.1. Plano “à esquerda”

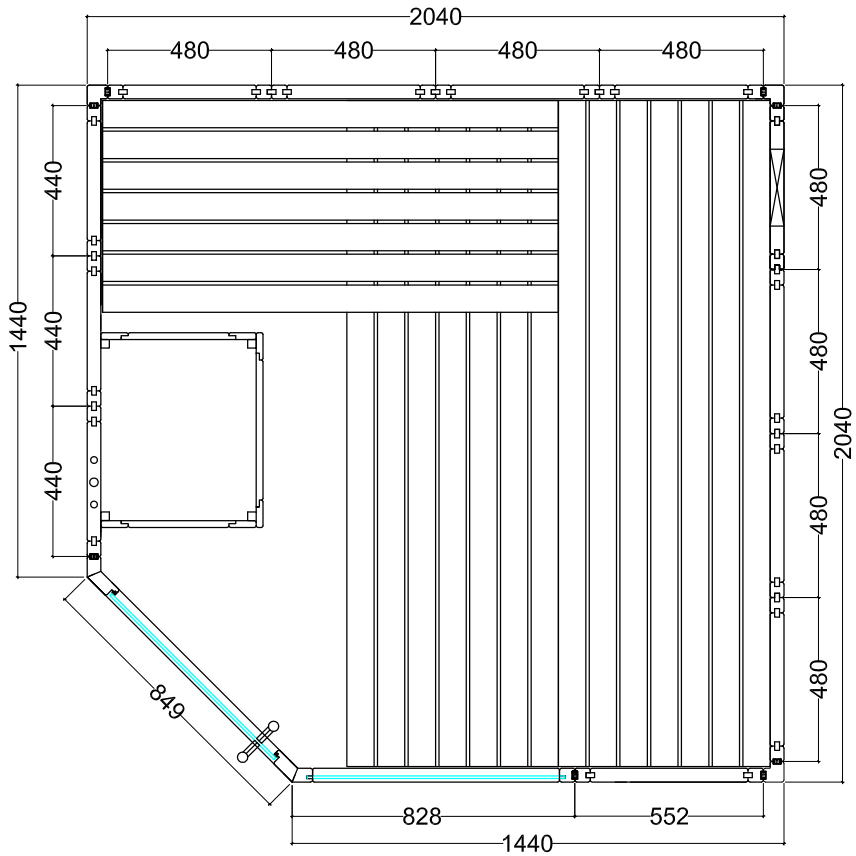

3.2. Plano “à direita”

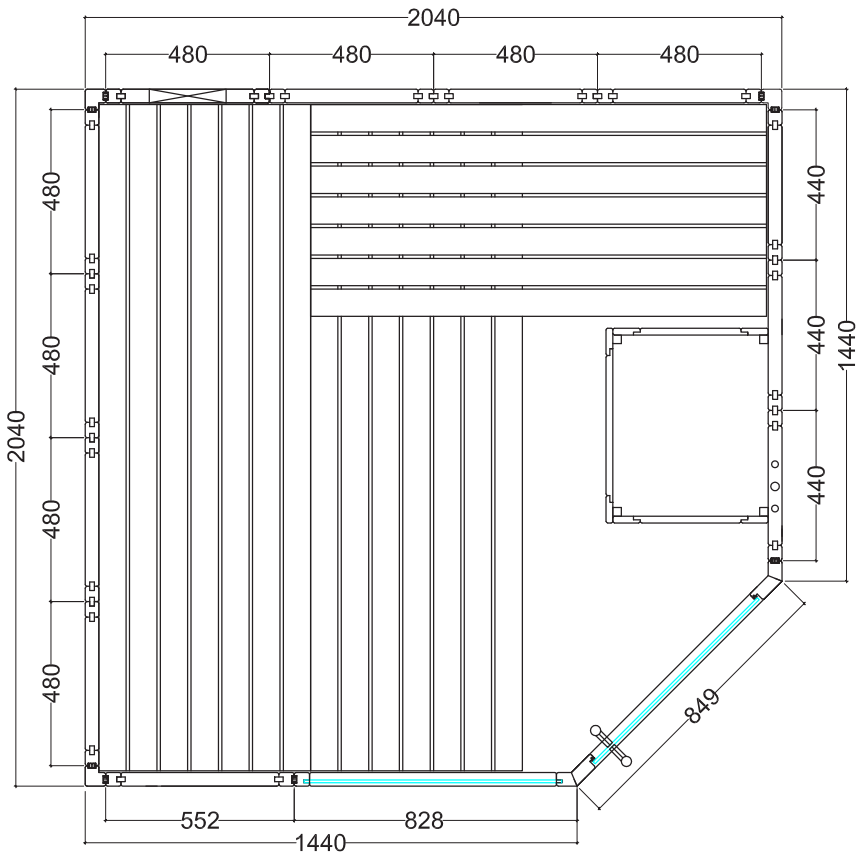

PT

3.3. Alterações na montagem do plano “à direita”

Para a montagem dos suportes de canto e dos suportes para vidro (página 13)

Remova os multiclipes do suporte de canto e do suporte para vidro.
Utilize o molde fornecido para o reposicionamento dos multiclipes.

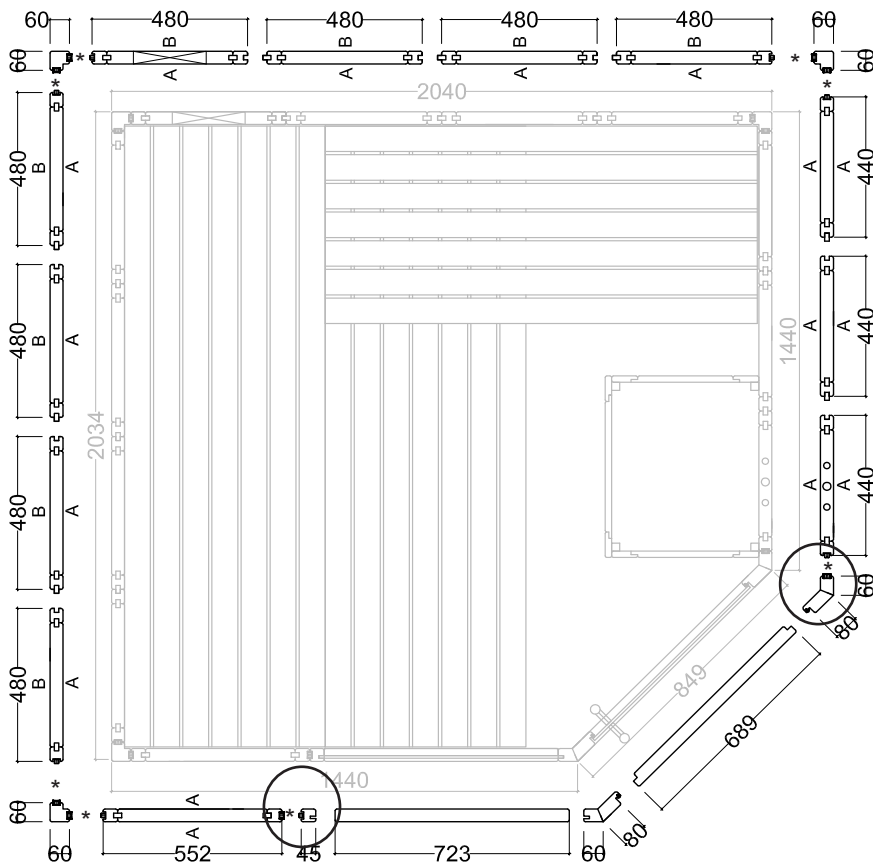

* Multiclipes



PT





sentiotec GmbH | Division of Harvia Group | Oberregauer Straße 48, A-4844 Regau
T +43 (0) 7672/277 20-567 | F -801 | info@sentiotec.com | www.sentiotec.com