

# WiFi-104 WiFi Lighting Control System



WiFi-104 is a versatile office/home lighting control system. Through WiFi function build-in mobile devices could control various types of LED lighting products after installing related software on our iOS or Android phones, tablet PCs and other mobile devices. It makes the LED lighting control more intelligence, networking and humanization.

WiFi-104 lighting control system integrated with four functional controls including dimming, color temperature adjusting, RGB and RGBW, which could be set as single color, color temperature(nature white + warm white and nature white + warm white + cool white), RGB and RGBW five types. Easy to control installed various of LED lights on WiFi Software. Meanwhile, it supports max 12 zones control. We could do what you think!

WiFi-104 control system supports connection directly or by router:

Direct connection: WiFi-104 and R4-5A/R4-CC can be controlled directly by mobile phone and pad, without any the third party network equipment.

Connection by a router, in addition to reach all the functions of direct connection and will not affect the normal Internet function at the same time. The more important role is to support freely switching multi control systems in the software interface, easily control more independent systems. eg, supporting 24 zones in 2 systems.

In addition, you can DIY the lighting on software according to your habits. You can DIY any color, any changing effects you like. It will let yourself relish in your sense of accomplishment for your special life color.

You can also use our 2.4G RF remote M12 is available if no mobile equipment, more options for you.

## 1. Product Parameter:

### WiFi-104 Controller

- Communication Standard: 2.4GHz Wi-Fi, 802.11b/g/n Protocol
- Input Voltage: DC12V~DC24V
- Max Current Load: 4A x4CH Max 16A
- Max Output Power: 192W/384W(12V/24V)
- WiFi Control Distance: 100m(Distance of cross-eyed)

- Working Temperature: -20°C~50°C
- Product Size: L128×W73×H45mm
- Package Size: L135×W80×H50mm
- Weight(G.W.): 290g

### R4-5A Constant Voltage Zone Receiver

- Wireless Frequency: 2.4GHz
- Input Voltage: DC5V~DC24V
- Max Current Load: 5A × 4CH Max 20A
- Max Output Power: 100W/240W/480W(5V/12V/24V)
- Remote Distance: 50m(Distance of cross-eyed)
- Working Temperature: -20°C~50°C
- Product Size: L175×W44×H30mm
- Package Size: L178×W48×H33mm
- Weight(G.W.): 110g

### R4-CC Constant Current Zone Receiver

- Wireless Frequency: 2.4GHz
- Input Voltage: DC12V~DC48V
- Output Voltage: DC3V~DC46V
- Output Current: CC350/700/1050mA×4CH (3 in 1)
- Output Power: 1.05W~48.3W×4CH Max 193.2W
- Remote Distance: 50m(Distance of cross-eyed)
- Working Temperature: -20°C~50°C
- Product Size: L175×W44×H30mm
- Package Size: L178×W48×H33mm
- Weight(G.W.): 110g

## M12 Remote Control

- Working Voltage: DC3V(CR2032 button battery)
- Transmitting Frequency: 2.4GHz
- Remote Distance: 30m(Distance of cross-eyed)
- Dimensions: L104 × W60 × H9mm
- Weight (G.W): 42g

## Software Technology Parameters

- Operation Platform: No Lower Than Android 2.2 or iOS5.1
- Screen Resolution: Above 960\*640
- WiFi Function: Must Have WiFi Function
- Byte: Android Edition (919K); iOS Edition (2.9MB)
- Language: English
- Category: Appliance
- Other: Free, No Plug-ins

## 2. Configuration Diagram

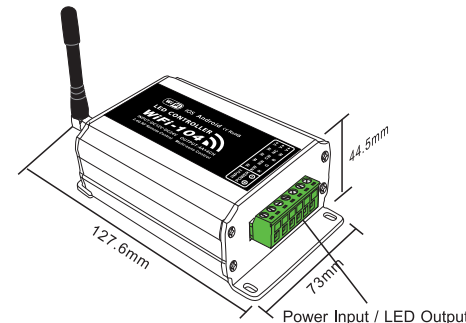

Side A

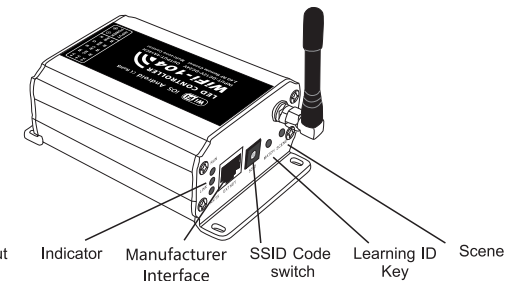

Side B

## 3. Controller Operating Instructions

### (1) Install / Uninstall ANT

clockwise to install the WiFi ANT, counterclockwise to take off

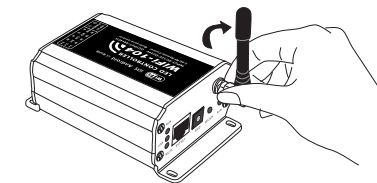

ANT installation instruction

### (2) Indicator Light Instructions

Indicator light	Instructions
● RUN	It flashes quickly about 25s during the electric initialization. Flashes once per second after initialization
● LINK	It keeps on when the mobile device connects to WiFi-104, and turns off when disconnected.
● RX/TX	It turns on when the controller receives or transmits the WiFi data. Turns off in the free time.

### (3) SSID Number Setting

Use code switch to set the controller's SSID Number--WiFi-104-SSID-X, X stands for a certain No. ranging from 0-F, totally 16 options. which means our product could set 16 isolated LAN in the same area. WiFi-104 will initialize each time the SSID NO. changed. Run LED indicator quick flashes about 25s, mobile device need to search and connect WiFi again after Initialization finished.

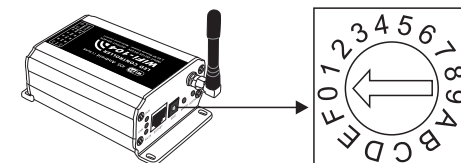

**(4) MATCH Key and SCENE Key**

Short press **MATCH** key, WiFi controller begins its learning ID status for the standard M12 remote (learning method, see P7)

Short press **SCENE** key sequentially to the user-saved scene modes, 4 scenes total.

**[ Restore factory settings/Delete password ]**

Long press **MATCH** key and **SCENE** key simultaneously more than 2 seconds, the machine will back to the default parameter, including the parameters of changing modes, zone and group parameters and network parameters. Machine default parameters: Only the 1st zone is present, default RGBW mode, the changing mode is RGB skipping, the brightest is white, no groups, network SSID is WiFi-104-SSID-X (X is the actual coding switch corresponding SSID values), WiFi-104 controller restore as directly connect and the connection password is blank.

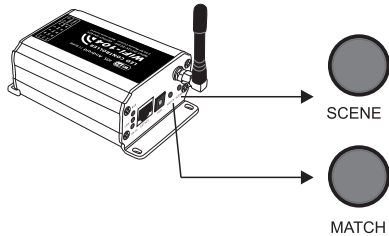

SCENE Key and MATCH Key

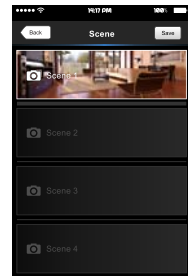

Scene Interface

**4. The instructions of APP software:**

A. Download App software



iOS scan for download



Android scan for download

B. Software Operating Instructions

**(1) Network Connection Setting**

WiFi-104 support 2 connection modes: Direct connection as router or connect by additional router.

• WiFi-104 controller direct connection as router:

Enter mobile device's WiFi setting, click the WiFi function, mobile device search the WiFi and list the working WiFi controller automatically(As Legend-1), Click the SSID number to connect (default is no password).

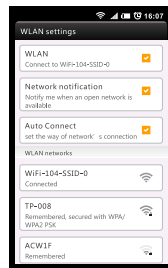

Android WiFi connection



Apple WiFi connection

(Legend-1)

• The mode of connect with a additional router:

**Connect WiFi-104 controller to the additional router network:**

A. Connect to the WiFi-104 controller, the same step as (1)

B. Click mobile device's icon to start the software, the software will search and list the working WiFi controller automatically, and there is a blue wireless icon (as Legend-2-1)

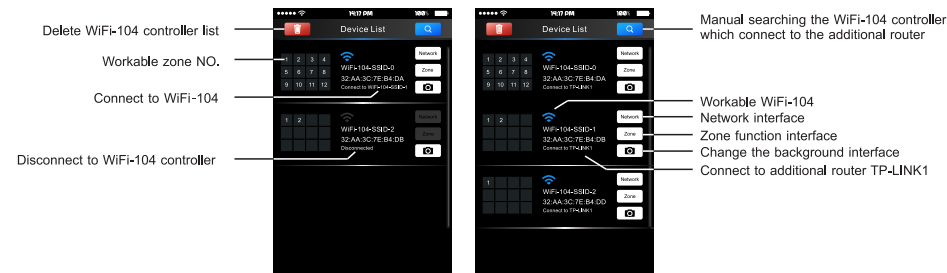

WiFi-104 as a router interface

Connect a additional router interface

(Legend-2-1)

(Legend-2-2)

C. Click "Network" key to enter Network interface(as legend-3-1), start "connect to exiting LAN", software will search the workable WiFi net SSID list, choose the specified router to connect (Att: do not choose WiFi-104 controller), can add the WiFi-104 controller to the wireless router(as legend-3-2 the wireless router TP-LINK1)

**Repeat the ABC steps if you need connecting multiple WiFi-104 controller to this wireless router.**

D. Exit WiFi-104 software, enter mobile device setting-wireless network setting, choose the wireless router to connect. Device List interface shows as legend 2-2 when re-open the WiFi-104 software. Completes the steps to connect to the additional router.

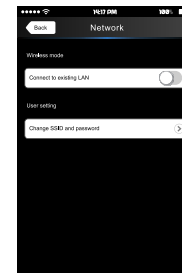

(Legend-3-1)

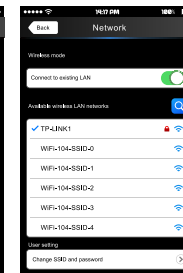

(Legend-3-2)

Network interface

**Att: In this connection mode, to avoid the mobile device automatically connect to WiFi-104 after the setting has completed, please click "workable WiFi-104" which under the mobile device "WiFi setting" and at the message box please click "Forget this network"(apple iOS) or "Cancel save" (SUNMUNG mobile phone is "forget") to cancel the save of WiFi-104 connection.**

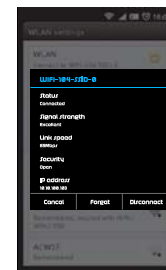

Android cancel store the WiFi-104 connection

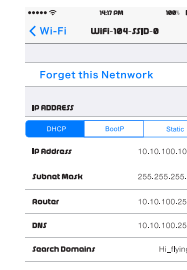

Apple cancel store the WiFi-104 connection

(2) Main interface ( 5 types total)

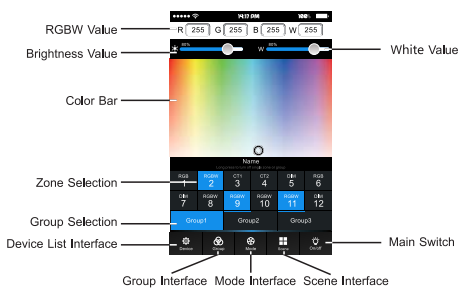

5 Main interface



(3) The learning method of Zone control

(1) Zones control

Click "Zone" on the **Device list** interface, enter **Zone set** interface. According to the lighting control requirements, turn on multiple zones, select the light type and naming zone.

[Att]: Default WiFi-104 controller itself as NO.1 zone, which can select if to connect lights. If not, sub-control can be replaced as the first zone.

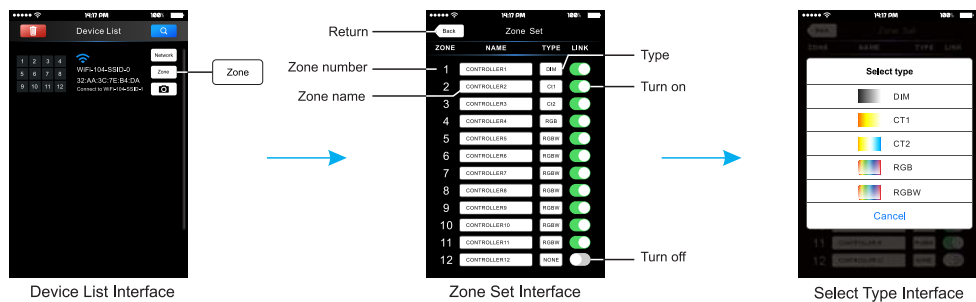

(2) Learning ID:

Short press "ID learning button" on the receiver, the running light go flash to keeps on. Then select the zone number on the software interface and touch the color bar 2-3 seconds. The buzzer keeps on (meantime the running light returns to flash), zone control and master control matched successful.

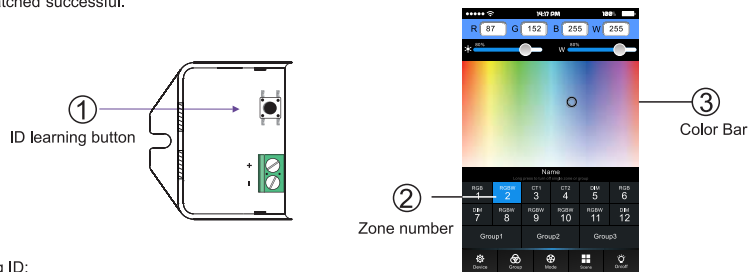

(3) Cancelling ID:

Long press "ID learning button" for 5 seconds, The buzzer in zone control long beep, succeed cancel the zone control learning.

Att: Reset function is available during ID cancellation. Considering dysfunction in rare cases, please cancel the ID and resync.

(4) Group

Group Features:

- Selecting several zones at the same time in group operation, multi-zones can be adjusted color, color temperature and brightness together
- Max. 3 groups, all zones at the same groups must be the same type, and one zone can belong to multiple groups simultaneously.
- Set up the group to enabled status, then the corresponding group will appear in the main interface
- It will automatically cancel the relevant zone group settings as you changed the type or set up enabled status of the zone at the Zone Set interface.

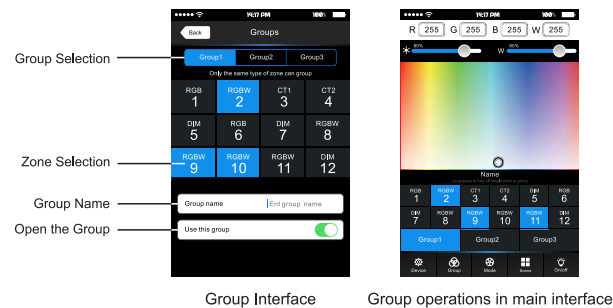

(5) Mode Interface for RGB / RGBW Type

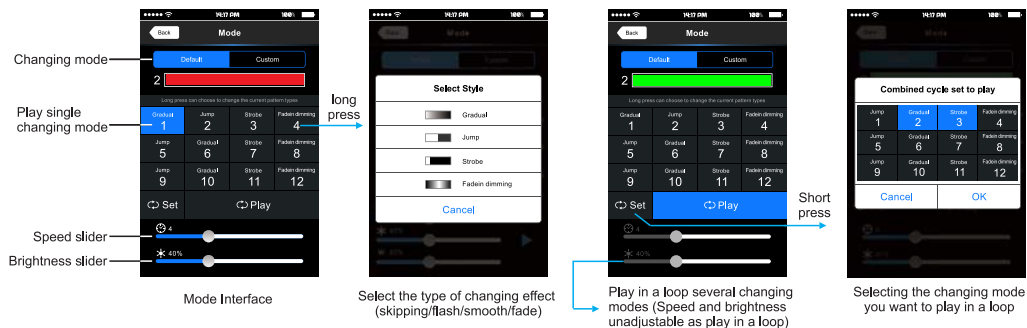

(6) DIY Interface

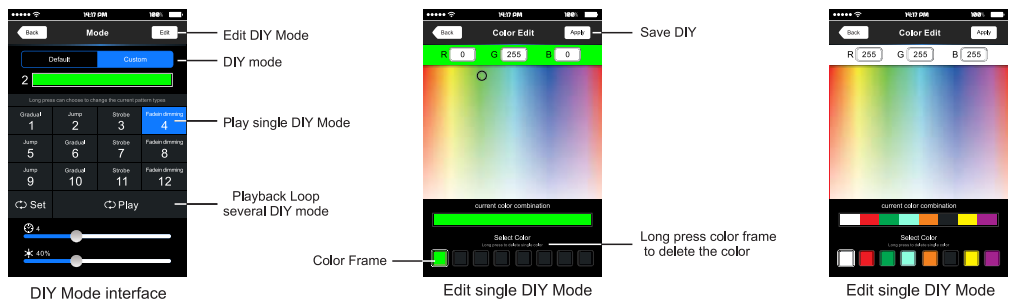

7). Scene Interface

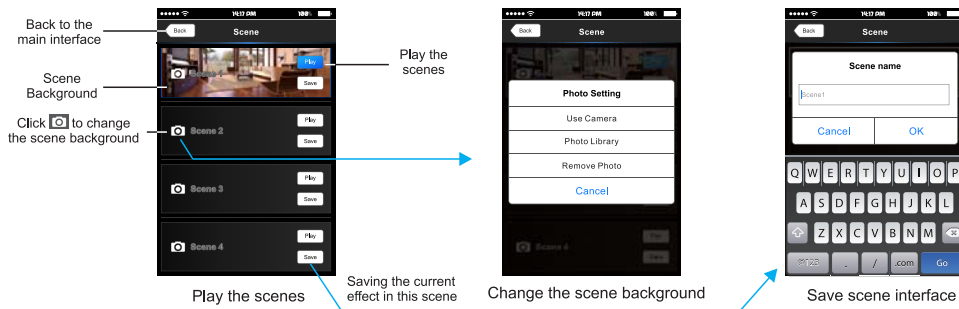

5. WiFi Network SSID Name and Password Setting

In Device list interface, click "Network key" to enter Network interface, select "Change SSID and Password" (Click " ") to enter User Setting interface. Typing new SSID name and password (Min.: 8 characters, consist of 0-9, a-z and A-Z). Click "Apply" button on the top right corner of the interface to save the changes.

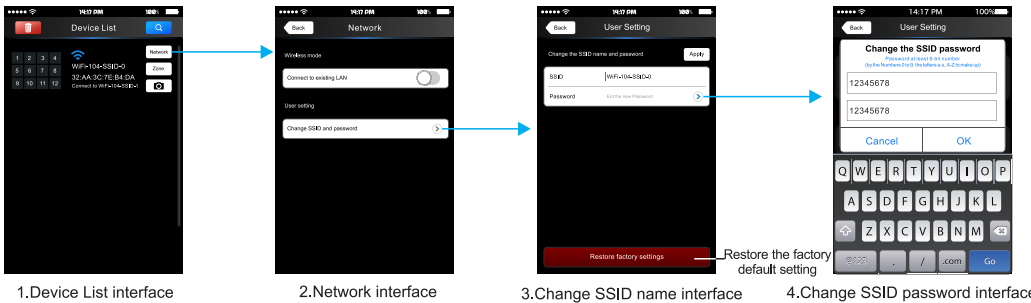

[Att]: In direct connection of the WiFi-104 as a router. Please exit software after changed the SSID name and the password, then enter the mobile device system setting to reconnect the WiFi-104

In additional wireless router connection, it only needs to click " " in Device List interface to search again the WiFi-104 controller after changed SSID name.

[Att]: If you forget the WiFi network password, please simultaneously press : "MATCH" and "SCENE" more than 2s to restore the factory default settings, so that can delete the WiFi network password (More details in page 3 [Restore factory settings/Delete password])

6. Remote operating Instructions

Learning ID

Short press learning key "MATCH" in WiFi-104 controller, the buzzer long beep, then press any keys on M12 remote, the buzzer keeps on again, succeed learning.

Cancel ID

Long press learning key "MATCH" in WiFi-104 controller more than 6s, the buzzer long beep, succeed cancel (cancel all learned remotes with WiFi-104 ).

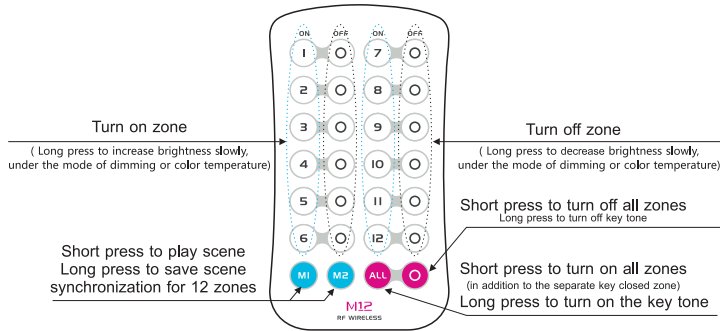

7. Wiring Diagram

1) Connect to the zones controller and LED lamps (the same way of WiFi-104 connection)

[Att]: WiFi-104 default to first zone, LED lamps can be connected or disconnected in master controller. If disconnected, wireless slave control can be the first zone. Multi-zones can be set to the same type or several types. For example, single color dimming in all zones, so all can be set to DIM type. Different zones can be set in different lighting types in multiple light types: Dimming, CT or RGB, etc. Lighting connect as follows:

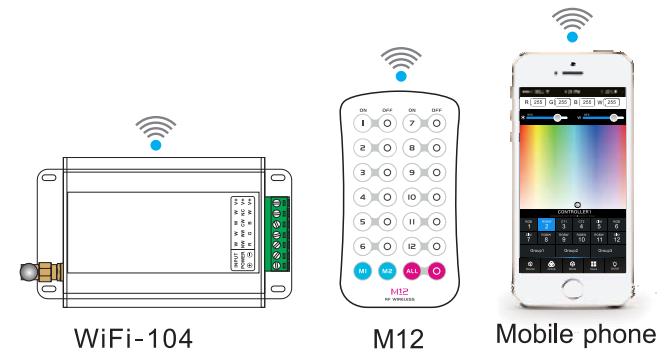
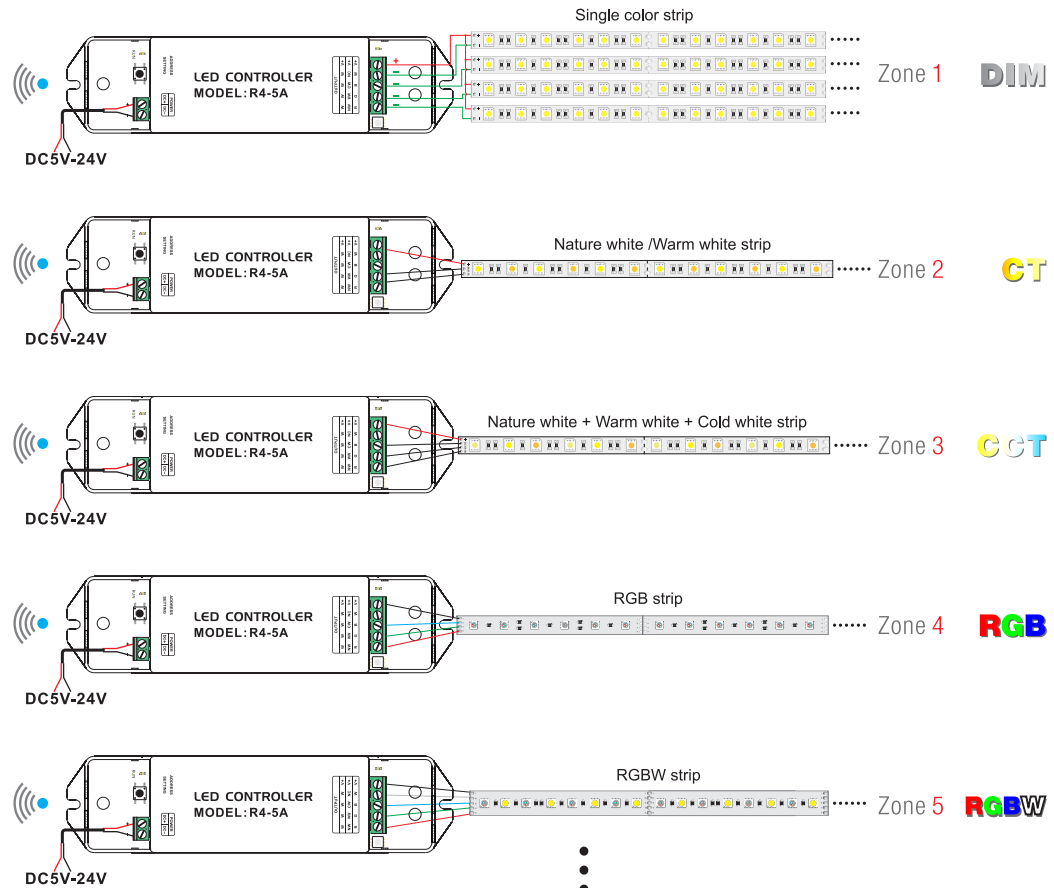

WiFi-104

M12

Mobile phone



2) Direct connection of WiFi-104 as router.

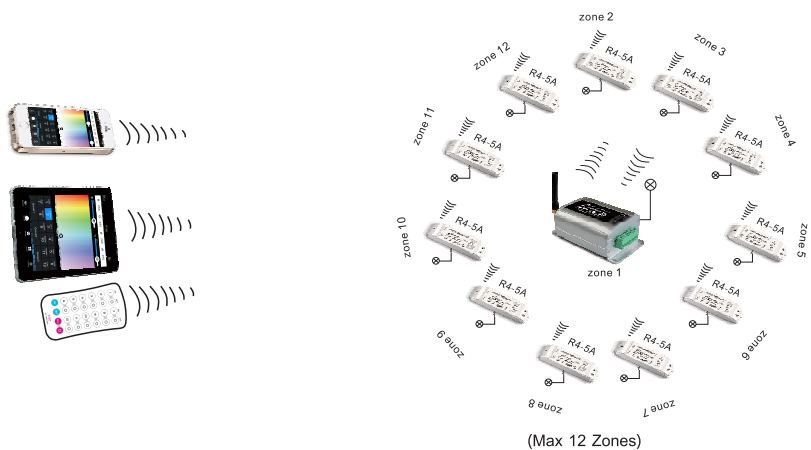

3) Connect by a router

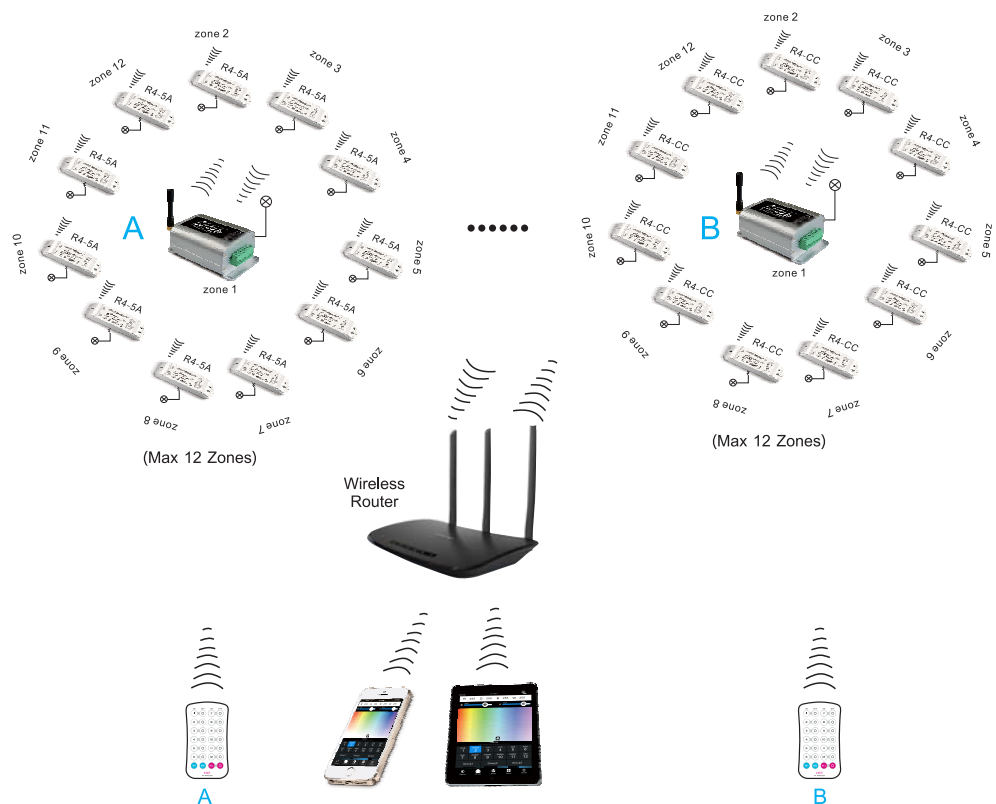

[Att] Unlimited zone receiver R4-5A/R4-CC can be installed for each zone within effective range.

4) Remote distance reference

[Att]: The following distance is measured at distance open environment, in an open environment testing wireless distance will be reduced. Please refer to the actual test distance before installation.

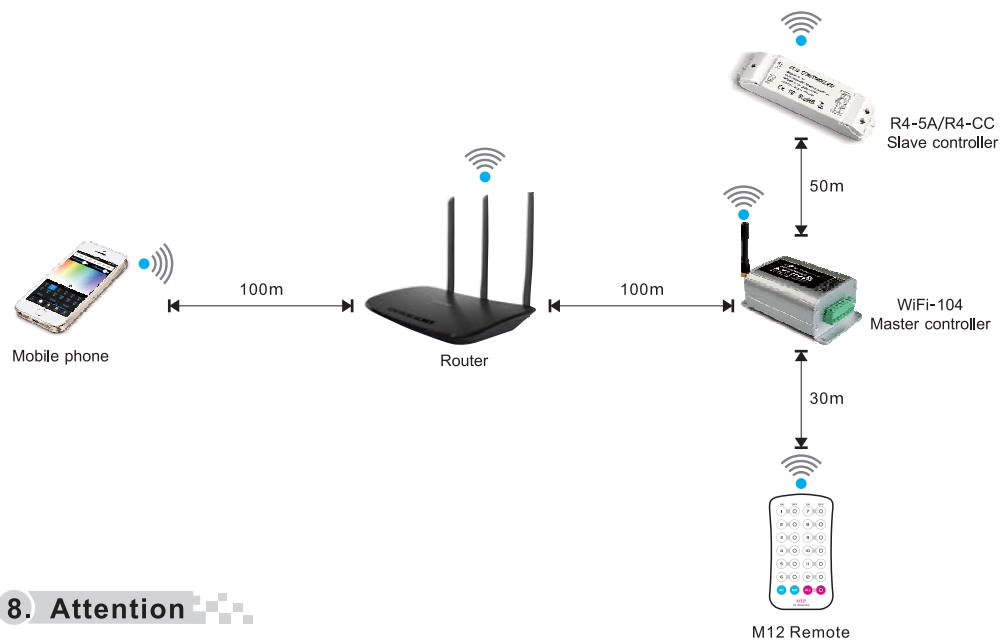

8. Attention

1. The product shall be installed and serviced by a qualified person.
2. This product is non-waterproof. Please avoid the sun and rain. When installed outdoors please ensure it is mounted in a water proof enclosure.
3. Good heat dissipation will prolong the working life of the controller. Please ensure good ventilation.
4. Please check if the output voltage of any LED power supplies used comply with the working voltage of the product.
5. Please ensure that adequate sized cable is used from the controller to the LED lights to carry the current. Please also ensure that the cable is secured tightly in the connector to avoid the accidents due to overheat and poor contact on the wire.
6. Ensure all wire connections and polarities are correct before applying power to avoid any damages to the LED lights.
7. If a fault occurs please return the product to your supplier. Do not attempt to fix this product by yourself.

9. Warranty Agreement

1. We provide lifelong technical assistance with this product:
  - A 5-year warranty is given from the date of purchase. The warranty is for free repair or replacement and covers manufacturing faults only.
  - For faults beyond the 5-year warranty we reserve the right to charge for time and parts.
2. Warranty exclusions below:
  - Any man-made damages caused from improper operation, or connecting to excess voltage and overloading.
  - The product appears to have excessive physical damage.
  - Damage due to natural disasters and force majeure.
  - Warranty label, fragile label and unique barcode label have been damaged.
  - The product has been replaced by a brand new product.
3. Repair or replacement as provided under this warranty is the exclusive remedy to the customer. Ltech shall not be liable for any incidental or consequential damages for breach of any stipulation in this warranty.
4. Any amendment or adjustment to this warranty must be approved in writing by Ltech only.

★ This manual only applies to this model. Ltech reserves the right to make changes without prior notice.

Update Time: 2014.06.06