

CLEVER-POOL ENERGY SAVER

ACCORDING TO: EN61800-5-1:2007

Designed by STARMATRIX GROUP INC.,

Installation, Operation & Maintenance Instructions

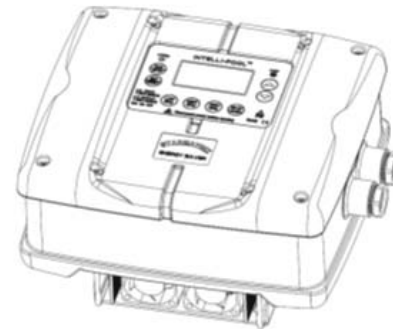

**Please leave this instruction booklet with the owner as it contains important maintenance and safety information.
Read this manual carefully before commencing installation**

WWW.STARMATRIX.CN

CONTENTS

1. SAFTY AND CAUTION	
1.1 READING BEFORE INSTALLATION.....	3
1.2 PRODUCT CHECK BEFORE INSTALLATION	4
1.3 ENVIROMENT CAUTION	5
2. PRODUCT DIMENSION AND PARAMETERS	
2.1 DIMENSION AND TECHNICAL PARAMETERS.....	6
3. INSTALLATION AND FUNCTION EXPLANATION	
3.1 INSTALLATION	7
3.1.1 INSTALLATION SKETCH AND DESCRIPTION.....	7
3.2 WIRE CONNECTION	8
3.2.1 WIRE CONNECTION AND DESCRIPTION FOR 2HP AC220V SINGLE PHASE IN - SINGLE PHASE OUT.....	8
3.2.2 WIRE CONNECTION AND DESCRIPTION FOR 3HP AC220V SINGLE PHASE IN - THREE PHASE OUT.....	9
3.2.3 WIRE CONNECTION AND DESCRIPTION FOR 5HP AC380V THREE PHASE IN - THREE PHASE OUT.....	10
3.3 RUNNING	10
3.3.1 CHECK BEFORE RUNNING.....	10
3.3.2 PROGRAMMING GUIDE	11
4. BUTTON AND FUCNTION EXPLANATION	
4.1 BUTTON AND FUCNTION EXPLANATION	13
5. PROTECTION AND TROUBLE SHOOTING	
5.1 ERROR CODE LIST AND EXPLANATION	14

1. SAFTY AND CAUTION

1.1 READING BEFORE INSTALLATION

Clever-Pool uses vector frequency technology and is a highly precious electronic device, to ensure for personal and property safty, please read carefully this instruction before using.

There are marks 【DANGER】 or 【CAUTION】 in this book, please strictly obey when moving,installing,using or checking the product.

 DANGER	1、 Please make sure to use the correct power supply.
	2、 Please make sure to close the control panel before power connection to avoid eletricity shock or explosion
	3、 Please make sure not to confuse the input and output terminals.
	4、 If our Clever-Pool is stocked over 2 years, please use a voltage adjuster to increase the voltage gradually when power connection.
	5、 Please DO NOT touch the wire terminals when power is connected.
	6、 Please wait after 10 minutes after the power is cut off when all the indication lights are off for further maintenance.
	7、 Please DO NOT use wet hands for operation.
	8、 Please ask for professional help if you need to change any parts, strictly forbidden to leave any metal things inside our Clever-Pool.

1. SAFTY AND CAUTION

 CAUTION	1、 Installation based on local safty rules.
	2、 Only professionals for installation and maintainence.
	3、 Power connection is required after control panel closed,electricity shock will occure if against this rule.
	4、 Do not touch the terminals,electricity shock will occure if against this rule.
	5、 Do not disconnect the wire connection if power is connected, serious personal damage will occure if against this rule.
	6、 Do not touch CMOS elements.
	7、 No voltage duration test allowed for our Clever-Pool, it will get semiconductor elements damaged.
	8、 Make sure air ventilation when in summer or high ambient temperature use,this will avoid condensate water formed and electrical faulty.
	9、 Please stock our Clever-Pool in a dry,ventilated and cool place.

1.2 PRODUCT CHECK BEFORE INSTALLATION

Each Clever-Pool is 100% tested before factory delivery, you need to check by yourself below:

- (1) If our Clever-Pool is the right model you ordered.
- (2) Any damage caused by transportation, if yes please do not connect to power supply.

1. SAFTY AND CAUTION

1.3 ENVIROMENT CAUTION

The correct enviroment for our Clever-Pool determines its right function and life. So the installation must obey below:

- IP65 for both outdoor and Indoor use
- Ambient temperature:-10℃~+40℃
- No direct sunshine
- No oil or salt
- No corrosive fluid
- No dust or metal scraps
- Away from radioactive or flammable substances
- No electromagnetic interference

2. DIMENSION AND PARAMETERS

2.1 DIMENSION AND TECHNICAL PARAMETERS

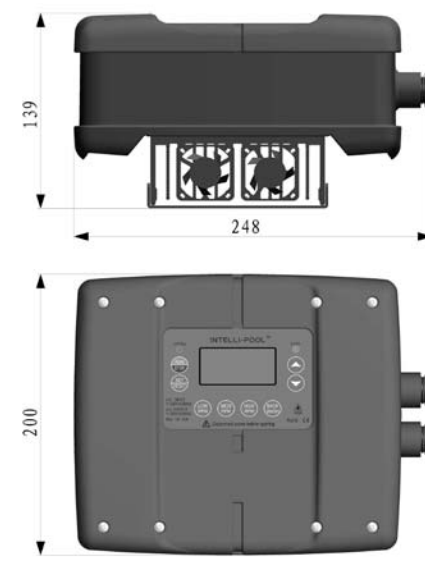
PARAMETER SHEET				Dimension
Model Item	Clever-Pool/220V	Clever-Pool M/220V	Clever-Pool/380V	
Input power	Single-phase AC	Single-phase AC	Three-phase AC	
Input voltage	220V±15%	220V±15%	380V±15%	
Input frequency	50/60Hz	50/60Hz	50/60Hz	
Output voltage	1~220V	3~220V	3~380V	
PUMP TYPE	SINGLE-PHASE	THREE-PHASE	THREE-PHASE	
Max.Power	MAX 2HP	MAX 3HP	MAX 5HP	
Max current	12A	10A	10A	
Mode option	Manual or Auto			
Cooling	By air			
Motor speed range	50Hz:1200~3000rpm			
	60Hz:1200~3600rpm			

3. INSTALLATION AND FUNCTION EXPLANATION

3.1 INSTALLATION

3.1.1 INSTALLATION SKETCH AND DESCRIPTION

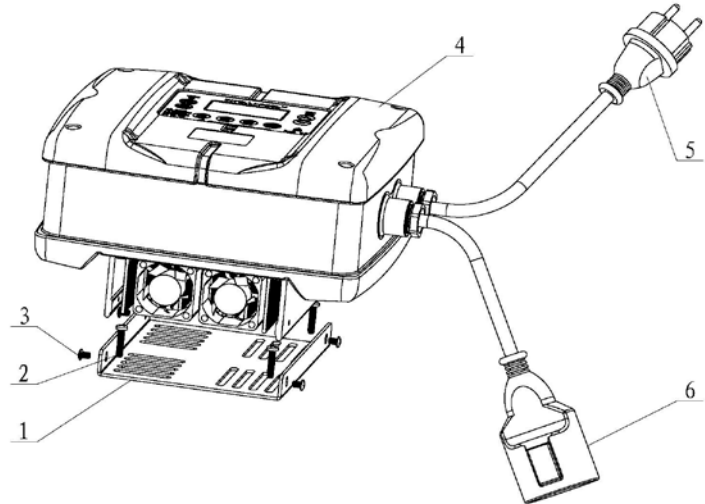
Sketch for Installation	Procedure and instruction
	<ol style="list-style-type: none">1. Use a cross screwdriver to take off the screws as shown 3 and plate 12. Put plate 1 in your installation place and use screws as shown 2 to fix plate 1.3. Put the control box 4 on plate 1 and fix with screws as shown 34. Connect the plug from pump to the part as shown 6.5. Connect plug 5 as shown to the correct power supply socket.6. Strictly follow the operation steps as indicated in this manual.

3. INSTALLATION AND FUNCTION EXPLANATION

3.2 WIRE CONNECTION

Wires has been preconnected before factory delivery as per request, if you need to re-connect the wires, please pay attention as below:

3.2.1 WIRE CONNECTION AND DESCRIPTION FOR 2HP AC220V SINGLE PHASE IN - SINGLE PHASE OUT

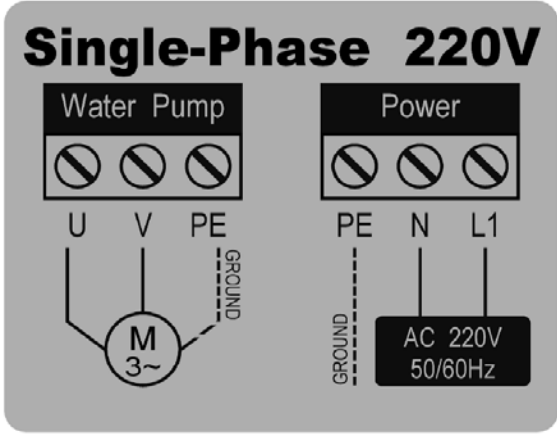
WIRE CONNECTION SKETCH	Procedure and instruction
 <p>The diagram shows a 'Single-Phase 220V' connection. On the left, a 'Water Pump' terminal block has three terminals labeled U, V, and PE. On the right, a 'Power' terminal block has three terminals labeled PE, N, and L1. Below the Water Pump terminals, a motor symbol 'M' with '3~' is shown. Wires connect U to the motor, V to the motor, and PE to a 'GROUND' point. Below the Power terminals, a power source symbol 'AC 220V 50/60Hz' is shown. Wires connect PE to a 'GROUND' point, N to the motor, and L1 to the motor.</p>	1.Disconnect power before opening the control panel.
	2.Make sure no connection between PE,N,L1 termials and U,V terminals.
	3.Wire connection operated only when power disconnected.
	4.Check if the input voltage from the power supply is compliance with clever-pool.
	5.No voltage duration test
	6.Screw torque for terminal screws more than 1.7N.m
	7.Ground link must be connected before operation.
	8.Must use the copper wires over 3G1.5mm ²
	9.Power supply connected only after the control panel is fixed,

3. INSTALLATION AND FUNCTION EXPLANATION

3.2.2 WIRE CONNECTION AND DESCRIPTION FOR 3HP AC220V SINGLE PHASE IN - THREE PHASE OUT

WIRE CONNECTION SKETCH	Procedure and instruction
<p>Three-Phase 220V</p> <p>Water Pump U V W PE</p> <p>Power PE N L1</p> <p>AC 220V 50/60Hz</p> <p>M 3~ GROUND</p>	1. Disconnect power before opening the control panel.
	2. Make sure no connection between PE, N, L1 terminals and U, V, W terminals.
	3. Wire connection operated only when power disconnected.
	4. Check if the input voltage from the power supply is compliance with clever-pool.
	5. No voltage duration test
	6. Screw torque for terminal screws more than 1.7N.m
	7. Ground link must be connected before operation.
	8. Must use the copper wires over 3G2.0mm ²
	9. Power supply connected only after the control panel is fixed,

3. INSTALLATION AND FUNCTION EXPLANATION

3.2.3 WIRE CONNECTION AND DESCRIPTION FOR 5HP AC380V THREE PHASE IN - THREE PHASE OUT

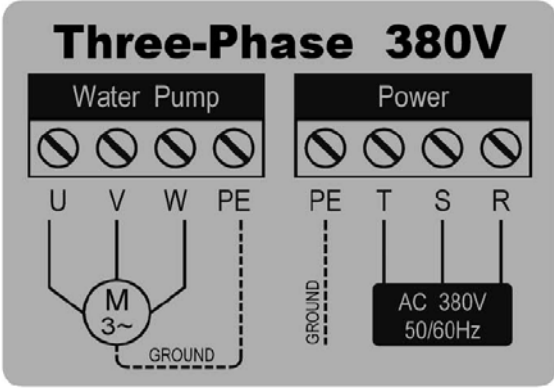
WIRE CONNECTION SKETCH	Procedure and instruction
 <p>Three-Phase 380V</p> <p>Water Pump U V W PE</p> <p>Power PE T S R</p> <p>AC 380V 50/60Hz</p> <p>GROUND</p>	1.Disconnect power before opening the control panel.
	2.Make sure no connection between PE,T,S,R termials and U,V W terminals.
	3.Wire connection operated only when power disconnected.
	4.Check if the input voltage from the power supply is compliance with clever-pool.
	5.No voltage duration test
	6.Screw torque for terminal screws more than 1.7N.m
	7.Ground link must be connected before operation.
	8.Must use the copper wires over 4G2.0mm ²
	9.Power supply connected only after the control panel is fixed,

3.3 RUNNING AND OPERATION

3.3.1 BEFORE RUNNING AND OPERATION

- 1.Check if installation and wire connection is 100% correct.
- 2.Check if any metal substances left in the product.
- 3.Check if wire terminals are well tightened.
- 4.Check if there are naked wires on the terminals touching other terminals.

3. INSTALLATION AND FUNCTION EXPLANATION

5. Check if the control panel is well closed.
6. A GFCI device must be used in the system.
7. Check if the power supply frequency is the same as CLEVER-POOL.
8. If all connections are correct, run with no load. If it is a three-phase pump, please check the motor rotation direction, you can choose the wire connection between UV, WV or WU.

3.3.2 PROGRAMMING GUIDE

1. The Clever-Pool has two running modes: Manual mode and Auto mode.
 - 1.1 Manual mode is used when you are connecting to a pool chlorinator or timer. The system time settings are not required to run in this mode.
 - 1.2 Auto mode is used when there is no chlorinator or timer and includes up to 4 separate timers with individual speed options. This is ideal for when you want to run your pool pump at different times and speeds to take advantage of the different electrical consumption.
 - 1.3 In stop and manual mode press the SET/RESET button once to switch to Auto Mode. In stop and Auto mode press the RUN/STOP button to switch to Manual Mode.

3. INSTALLATION AND FUNCTION EXPLANATION

2. Manual mode

In stop mode the display will now show MANUAL, LOW RPM and the speed in rpm.

Press the up or down buttons to select the speed. Alternatively press one of the systems, preset speed buttons LOW RPM, MEDI RPM, HIGH RPM.

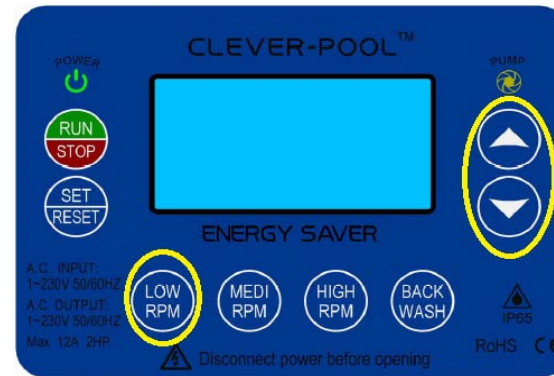

Press the RUN/STOP button to put it into run mode, this will start the pump. When the chlorinator timer turns off, the CLEVER-POOL will store the speed and resume at that speed when switched on again.

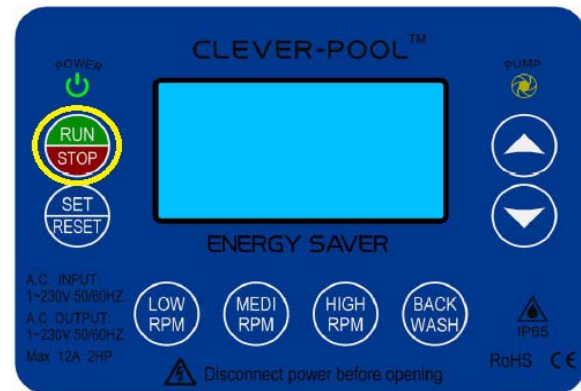

To stop the pump simply press the RUN/STOP button again.

3. INSTALLATION AND FUNCTION EXPLANATION

3. Back Wash mode

In stop mode press the SET/RESET button once. The display will now show MANUAL, LOW RPM and the speed in rpm.

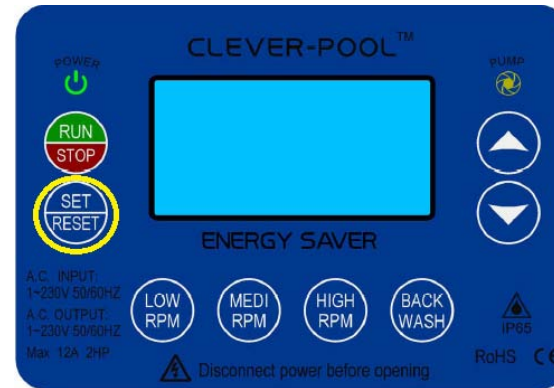

Press the BACKWASH button. The display will now show backwash and the rpm.

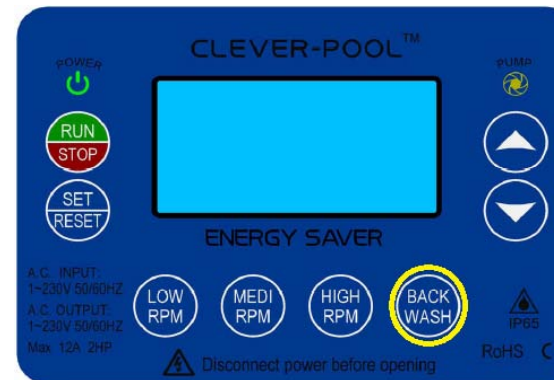

3. INSTALLATION AND FUNCTION EXPLANATION

Press the RUN/STOP button to put it into on mode, this will start the pump.

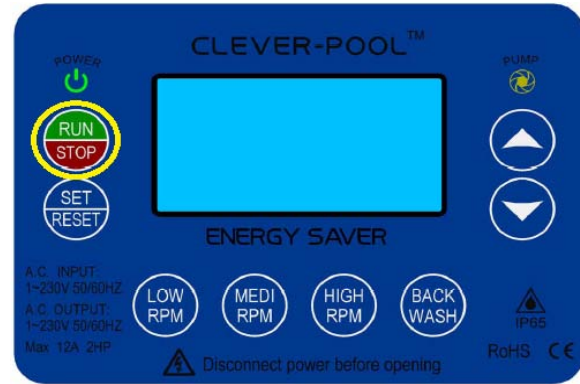

Press the RUN/STOP button to stop the pump

4. Time setting

4.1 Current time

In stop and Auto Mode, Press UP and Down button to set Current time,

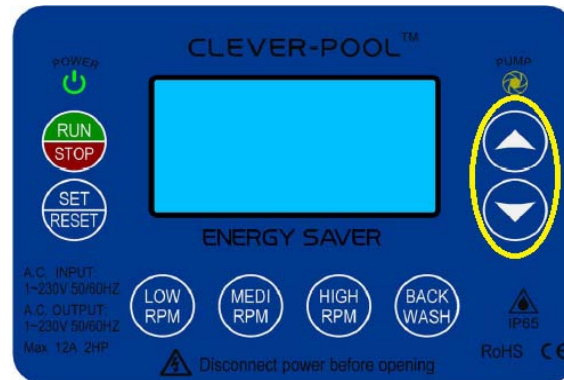

3. INSTALLATION AND FUNCTION EXPLANATION

Press the SET/RESET button to step over from hours to minutes. The display will then flash the minutes digits.

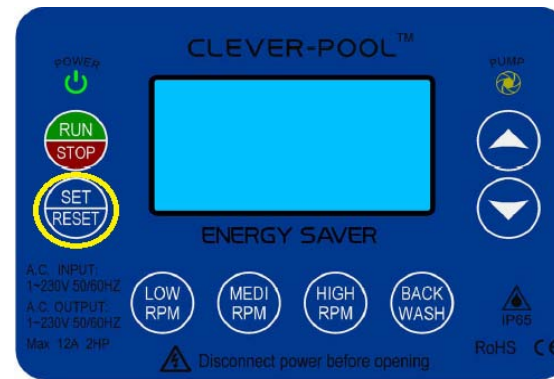

Press the SET/RESET button to store the time. The display will now show the current time with flashing cursor and the word shown at the top.

4.2 Auto Mode timer and Speed setting

In stop mode press the SET/RESET button, The display should show CURRENT TIME, START TIME, STOP TIME and the stored

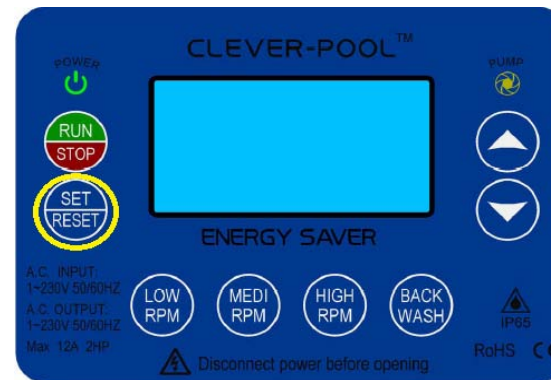

3. INSTALLATION AND FUNCTION EXPLANATION

Press the up or down button to select the hours.

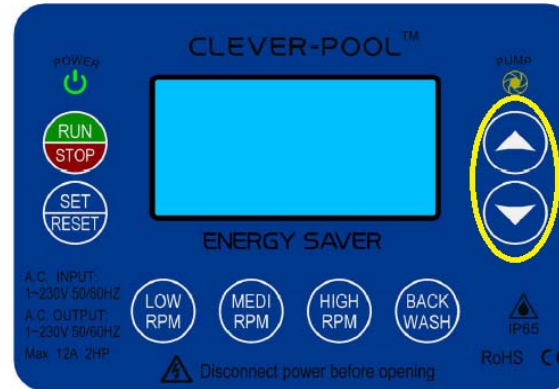

Press the SET/RESET button to step over from hours to minutes and from Start Time to Stop time

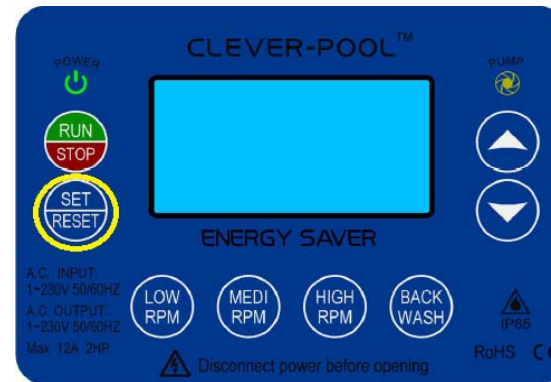

3. INSTALLATION AND FUNCTION EXPLANATION

Press the SET/RESET button to step to SPEED setting. The display will now show the flashing four digits for speed, which is the speed for AUTO MODE 1. Press the up or down button to change motor speed. Alternatively press one of the systems preset speed buttons LOW RPM, MEDI RPM, HIGH RPM.

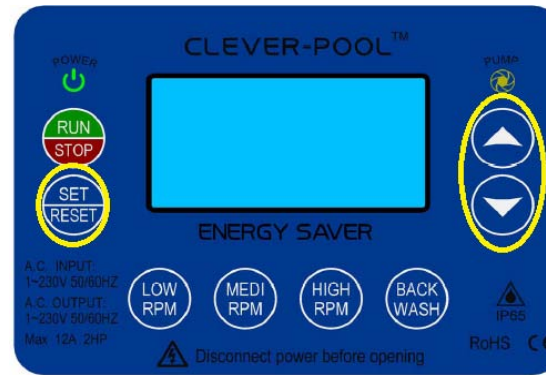

Press the SET/RESET button to store the speed and step over to AUTO MODE 2. The display should show CURRENT TIME, START TIME, STOP TIME and the stored time with hours digits flashing. This is the start time for AUTO MODE 2.

Repeat steps above to set speed, start and stop times for AUTO MODE 2 3 and 4. Pressing the SET/RESET button after selecting the speed for Auto mode 4 will finalize the timer settings.

The display will go blank and return to stop mode with the current set time displayed.

Alternatively if you only require one time period per day press the SET/RESET button to cycle through time a speed settings of the remaining TIMERS ensuring all start and stop times are set to zero's or to the same time period. Please note all settings for AUTO MODE 1 to 4 will be retained in the event of power loss.

After all timers have been set. The CLEVER-POOL will then start and stop the pump at set times and speeds.

4. BUTTON AND FUNCTION EXPLANATION

4.1 BUTTON AND FUNCTION EXPLANATION

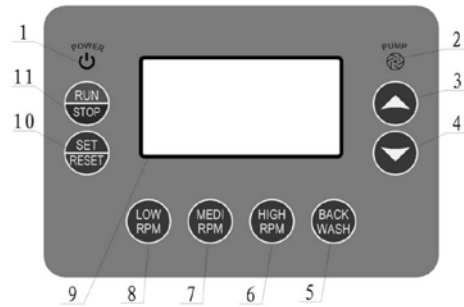

Number	Name	Explanation
1	Power light	Power supply connected or disconnected
2	Pump light	Pump on or off
3	Increase	Increase the parameter
4	Decrease	Decrease the parameter
5	Full RPM	Pump motor RPM setting
6	High RPM	Pump motor RPM setting
7	Medium RPM	Pump motor RPM setting
8	Low RPM	Pump motor RPM setting
9	LCD screen	Showing all parameters
10	Setting	Parameter setting or re-set system
11	Run/Stop	Manually control pump run or stop

5. PROTECTION AND TROUBLE SHOOTING

5.1 ERROR CODE LIST AND EXPLANATION

	PROTECTION	CODE	EXPLANATION
1	Too Low voltage	LU	When the voltage is below 160V it shows LU on the screen, when the voltage comes normal from the grid, the error code disappears automatically.
2	Over voltage	OU	When the voltage is over 285V it shows OU on the screen, when the voltage comes normal from the grid, the error code disappears automatically.
3	Over temperature	OC	When the temperature in the casing is over 80°C, it shows OC on the screen till the temperature drops down to 55 °C, the error code disappears automatically.
4	Over load	OLD	When the output ampere is 1.6 times higher than the rated ampere and working for 15 seconds, it shows OLD on the screen, it needs to cut off the power supply and eliminate the problem, then re-plug the power for normal work.
5	Short circuit	OLP	When the output of the inverter is short-circuit, it shows OLP on the screen, it needs to cut off the power supply and eliminate the problem, then re-plug the power for normal work.
6	Lack phase (For 380V version)	OP	When there is a phase wire missing connection at the input, it shows OP on the screen and it needs to cut off the power supply and eliminate the problem, then re-plug the power for normal work.