

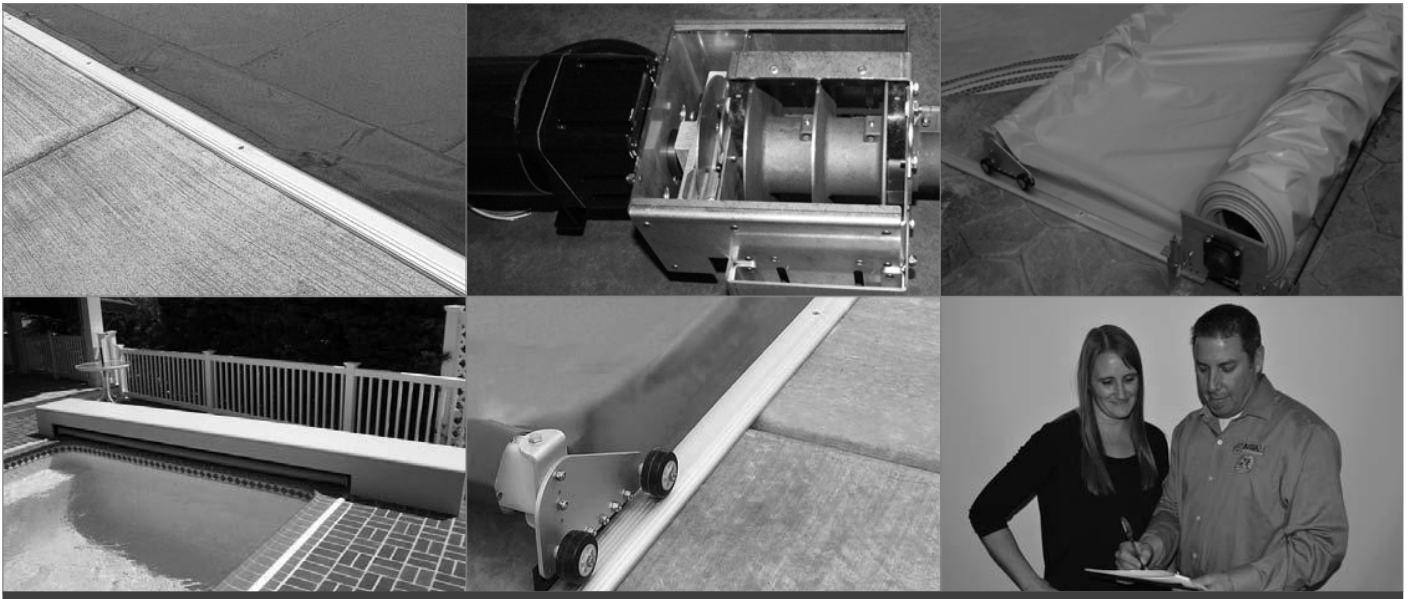

THE ECLIPSE™ AUTOMATIC SAFETY COVER  
DECKMOUNT SYSTEM

INSTALLATION GUIDE

## The ECLIPSE™ Safety Pool Cover



## SECTIONS

System Parts Reference .....	3
Standard Top Track.....	4-6
Mechanism .....	7-10
Cover Fabric.....	11-16
Home Owner & Builder Installation Checklists.....	17-18

### Tools Required

- |   |   |
|---|---|
| 1. Hammer drill or rotary hammer                  | 18. Crescent wrench                             |
| 2. Masonry drill bit 1/4" x 6" (1/4" x 12" bit)   | 19. 100 ft. & 25 ft. tape measure               |
| 3. Extension cords                                | 20. Chalk line ( use white chalk)               |
| 4. #2 and #3 Phillips & standard screw drivers    | 21. Nut drivers - 5/16", 3/8", 7/16", 1/2"      |
| 5. Ratchet with 5/16" - 3/4" sockets              | 22. Chisel ( wood & concrete)                   |
| 6. Hacksaw  | 23. Scissors                                    |
| 7. String line                                    | 24. Wire strippers                              |
| 8. Utility knife                                  | 25. Set of box/open end wrenches - 5/16" - 3/4" |
| 9. Broom  | 26. 6" level                                    |
| 10. Hammer & rubber mallet                        | 27. Set of allen wrenches                       |
| 11. Pliers - standard, needle nose & channel lock | 28. Wire  |
| 12. Files - round, triangular & flat              | 29. Electrical tape                             |
| 13. Matches or cigarette lighter                  | 30. Small sledge hammer                         |
| 14. Carpenter's square                            | 31. Vice grips                                  |
| 15. 5/16 hex head driver bit with 12" extension   | 32. #2 #3 Phillips drill bits                   |
| 16. Drill (cordless or corded)                    | 33. Pencil or marker                            |
| 17. Set of drill bits (1/4" down to 1/16")        | 34. 6 - 8 clamps                                |

### Optional Power tools

Skill saw with carbide tipped blade  
Sawzall, Grinder.

Mechanism Components

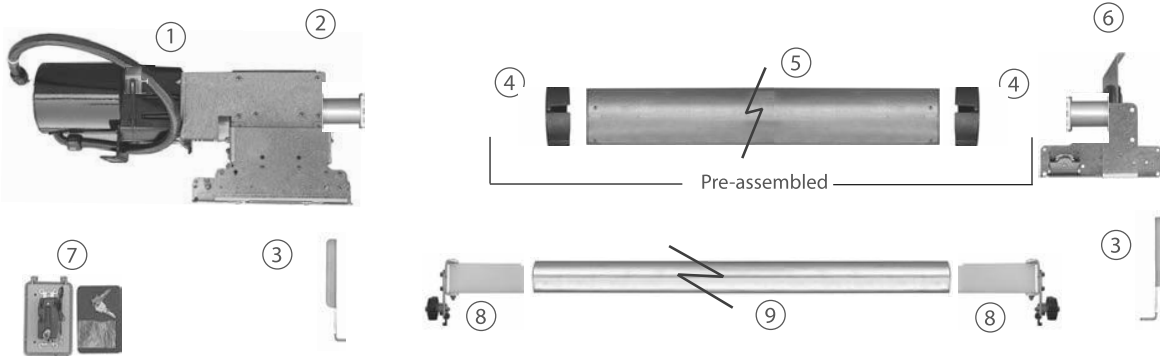

Cover Fabric

Cover Track Types

Cover Pump

Guide Feeds

Track Rollers

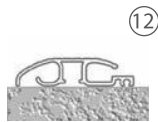

Misc. Hardware

Item #	Part #	Description
1	A0610	Motor & housing, standard 3 wire Bison motor
2	A1590	Mechanism Eclipse Deck Left
	A1591	Mechanism Eclipse Deck Right
3	M4661	Deckmount system mounting foot (Eclipse)
4	A2374	Tube Insert/Cone for Eclipse 6 inch tube Die Cast
5	X0001	Tube 6 aluminum STD per ft.
6	A0049	Non Motor end assembly Deck Left
	A0048	Non Motor end assembly Deck Right
7	A0605	Key Switch - Leviton assembly complete with light
8	A1565	Wheel assembly 805 TG Set
9	X0021	Tube 3 in LE 20 ft. STD
10		Cover Fabric
11		PowerFlex Rope - Lengths will vary with cover length
12	X0656	Track TG 403 for detachable rope 22 ft. STD
13	E1130	Little Giant cover pump and instructions
14	A1071	Guide feed 2 piece SS TG 403 & pre 403
15	H0334	Screw PFSM 12 x 1-3/4
16	E1086	Bonding Lug Copper
17	A2423	Pulley end cap TG SS ASSEMBLY
18	E1098	Solid cooper #8 bonding wire 4ft. long
19	H0152	Screw PPMS 10-32 x 1/2
20	H0150	Screw PPMS 10-32 x 5/8
21	H0176	Nut Nylock 10-32
22	H0075	Rope loop black plastic
23	H0006	Washer Split Lock
24	H0313	Screw HHW tek #10 x 1/2 SS
25	H0324	Anchor plastic STD #12
26	H0331	Screw HHWSM 12 x 1-1/2 with slot
27	H9711	Carriage bolt 1/4-20 x 5/8 SS
28	H0096	Bolt 3/8 - 16 1/14"
29	H0276	Nut Nylock 1/4-20
30	M0105	Track splice TG 403 3/8 x 3/8 x 3 in STD
31	H9630	Spring Pin for track alignment SS /8 in x 1 in
32	H9705	Bolt HH 1/4-20 x 1/2 in SS
33	H9763	Screw #12 x 1 Tek
34	H1101	Screw PPMS 10-32 x 1 3/8
35	H0001	Washer split lock 1/4 in
36	A1972	Electrical junction box with threaded adapters
37	A0113	Cover Roller & Bracket



The parts list at above is typical for most pools up to 20' x 40' and includes all parts necessary to install the Coverstar ECLIPSE system, however, parts will vary for longer or wider pools and according to your specific order.

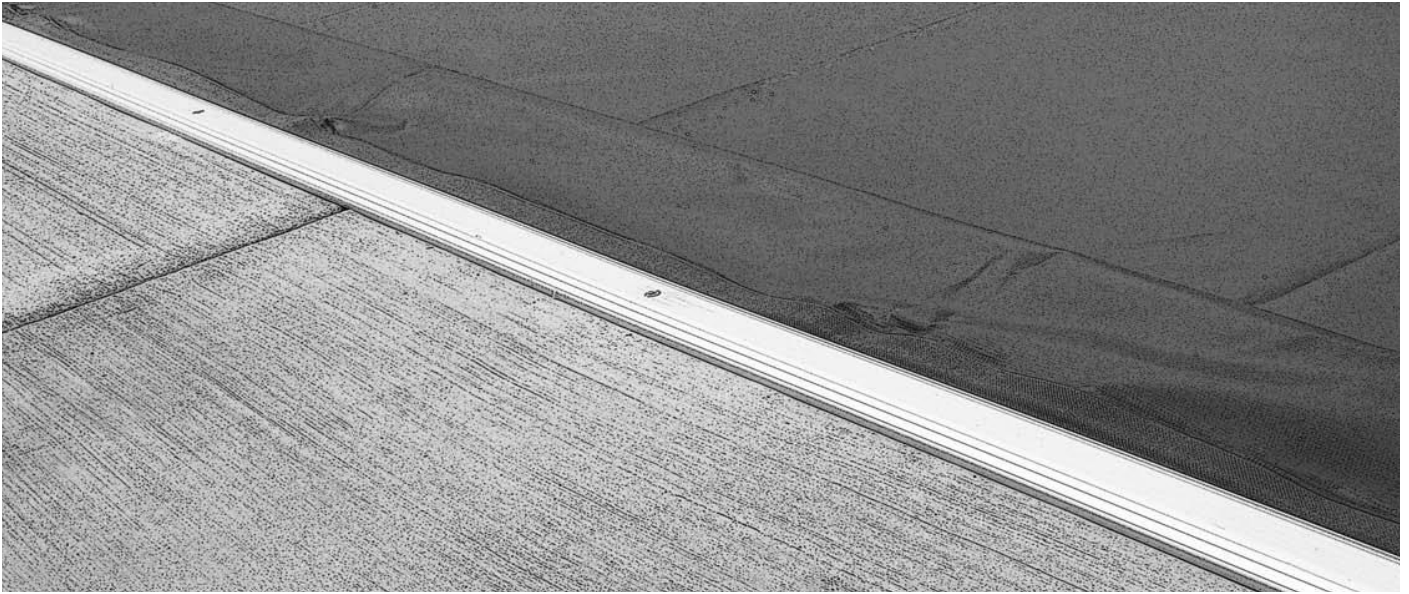

## STANDARD TOP TRACK

Step By Step Instructions	Page/Step
Laying out the cover tracks.....	5/2
Splicing the tracks together.....	5/4
Cutting the tracks to length .....	5/9
Checking for square .....	6/12
Attaching the tracks to the deck.....	6/14

## Step By Step Instructions

(Numbers in parenthesis refer to hardware on page #3)

## Installation Guide

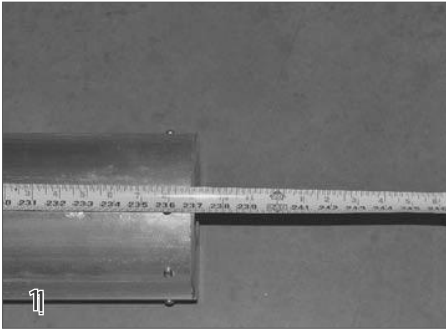

To determine if the cover system was ordered correctly for the pool, the length of the roll up tube should be 3 inches shorter than the track space.  
For example, for a 20 ft track space, the correct length of rollup tube is 19 ft 9 in.



### Laying Out The Cover Tracks

Lay the cover tracks on the deck on both sides of the pool. When positioning the tracks, there needs to be at least 7" of clearance from the top of the finished deck to the bottom side of slides, ladders and hand rails for the wheel assemblies and leading edge to pass under without damaging the cover system.



Extend the tracks at least 18" past waterline. Center the pool shape between the pool tracks where possible. Measure and mark the track space and track length on the deck.



### Splicing The Tracks Together

Before splicing the sections of track together, file all track ends thoroughly, rounding all edges and removing all burrs. This step is extremely important. The cover can be damaged very easily by metal burrs and this damage is not covered by the warranty.



Tap the spring pin (31) into the round splice channel. Slide the center splice (30) into the center channel.

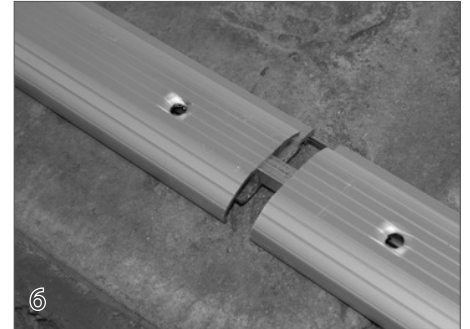

Join the track sections together by hand.



At one end, use a rubber mallet to tap the track sections together.



The two sections of track should be tight together.



### Cutting The Tracks To Length

With the track extended at least 18" past the waterline at the opposite end of the pool, cut the tracks so they extend 18" past the waterline at the mechanism end.

## Step By Step Instructions

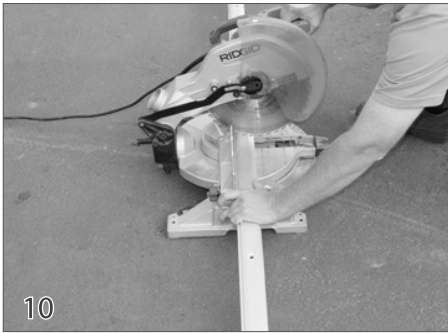

10  
Cut the track at the mechanism end to the proper length using a miter saw. It is important to have square cuts on the track. Note: Always wear safety goggles when using powered equipment.



11  
File the track ends on both sides of the pool making sure to round all edges and remove all burrs. This step is extremely important. The cover can be damaged very easily by metal burrs and this damage is not covered by the warranty.



12  
**Checking For Square**  
Measure the track space, track length and diagonals to make sure the tracks form a perfect square.

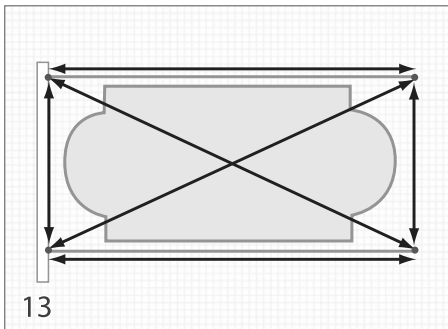

13  
Lengths, widths and diagonal dimensions must be equal to each other or the system will not operate properly.



14  
**Attaching The Tracks To The Deck**  
Place the Tracks into position on the deck in the marked positions. Make sure that the tracks run completely straight on both sides of the pool. Drill through the pre-drilled track holes into the deck. Drill at least 3" deep.

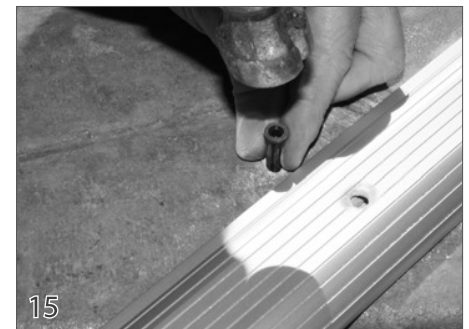

15  
Move the tracks to the side to expose the holes in the deck. Tap the plastic anchors (25) into each hole.



16  
Place the track back over the holes in the deck. Fasten the track screws (15) halfway through the tracks into the plastic anchors. The screws will be fastened completely later in the installation.



## MECHANISM

Step By Step Instructions	Page/Step
Attaching the roll-up tube .....	8/2
Positioning the roll-up tube/mechanism.....	8/4
Extending the Pulley brackets .....	8/5
Anchoring the mechanism .....	9/14
Wiring the electrical switch.....	10

## Step By Step Instructions

(Numbers in parenthesis refer to hardware on page #3)

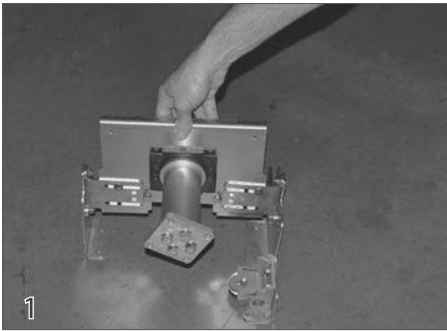

Position the motor end and non motor end of the mechanism roughly in the position that they will be mounted.

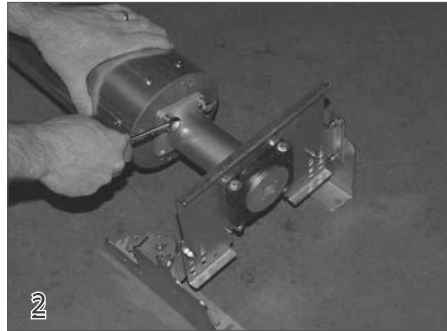

**Attaching the Roll up Tube**  
With the Non Motor End turned upside down, attach the cone for the non motor end to the roll up tube using the 3/8" x 1 1/4" bolts (28) and lock washers (23) provided.

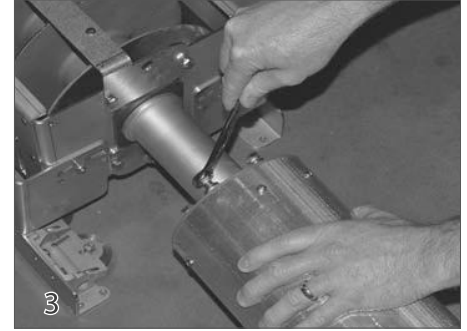

With the motor end turned upside down, attach the cone on the motor end using the same bolts (28) and lock washers (23). Tighten the bolts with a 9/16" wrench.

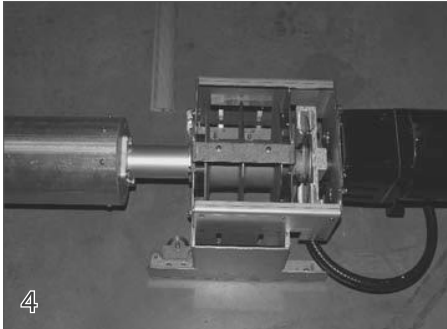

**Positioning the Mechanism**  
Place the mechanism on the pool deck roughly in the position that it will be anchored.

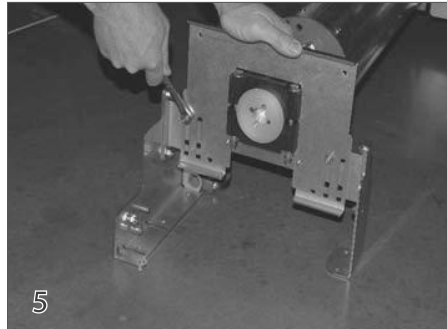

**Extend the Pulley Brackets**  
Use a 7/16" wrench to loosen the nylock nuts on the adjustable brackets of the non motor and motor ends of the mechanism.

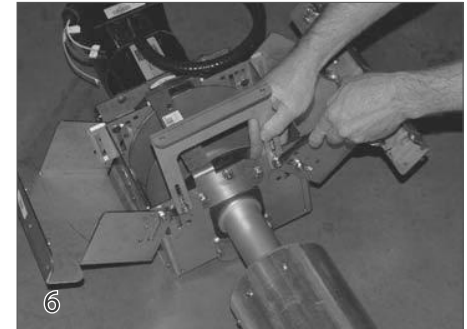

Install one mounting foot on the motor end and one on the non motor end using the 1/4 x 20 bolts (32) provided. Tighten securely.



Turn the mechanism over. Extend the pulley brackets so they will match the elevation set by the mounting foot. This height is adjustable depending on the length of the cover.

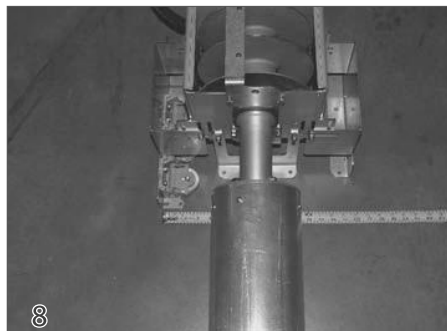

Make sure the pulley brackets are spread wide enough to provide good stability.



With the mechanism and tube assembled, check the roll-up tube for level. If the deck isn't level, the distance from the deck to the tube should be the same on both ends of the tube. This is crucial for a properly operating cover. Adjust the non motor end as needed to level the roll-up tube.



## Installation Guide

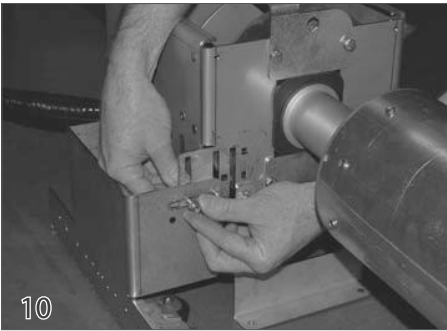

10

Use a 7/16" wrench to tighten the nylock nuts. Additional carriage bolts (27) and nylock nuts (29) are provided and can be used as reinforcement for the pulley brackets as needed.

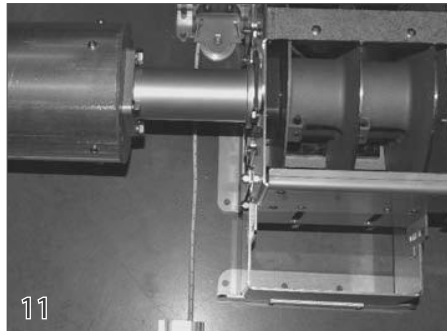

11

Align the mechanism on the motor side first by using a piece of rope. Extend it from the outside channel of the track to the pulley to make sure the rope will feed directly into the pulley.

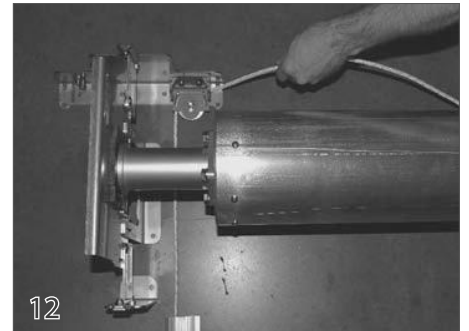

12

Go to the non-motor end and make sure the rope will come straight back from the rope channel of the track to the pulley. If the ropes do not come straight back, the mechanism should be moved to balance the rope angle on both sides. Only a 1/2" variance from straight is allowed on either side.

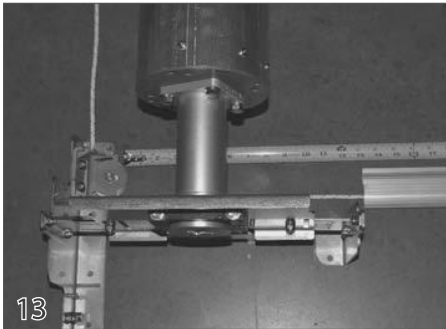

13

On both the motor end and non motor end of the mechanism, measure from the cover track to the pulley. It is important that the mechanism be mounted square to the cover track.



14

**Anchoring The Mechanism**  
Use a 1/4" bit and hammer drill to drill through the mounting holes in the mechanism into the deck.



15

Use the 1 1/2 hex head screws (26) and anchors (25) provided to secure the motor end and non motor end to the deck.

## Step By Step Instructions

### Electrical Wiring and Bonding

The automatic cover system must be bonded to meet the National Electrical Code. Bond both tracks to the mechanism by attaching a bonding lug to the guide feed screw and running a #8 solid copper bond wire to the mechanism. (See page 13)

Bond the lid to the mechanism by drilling a hole in the lid at either end and attaching a bonding lug. Run bond wire from this lug to the mechanism.

All brackets and any other metal over 4" long should likewise be bonded to the mechanism. There should be a bond wire extended from the equipment pad to the cover box, so it too can be attached to the mechanism.

Note: Builder is responsible to bring proper electrical lines, conduit and bonding to the mechanism. Electrical wiring diagram and details are shown below.

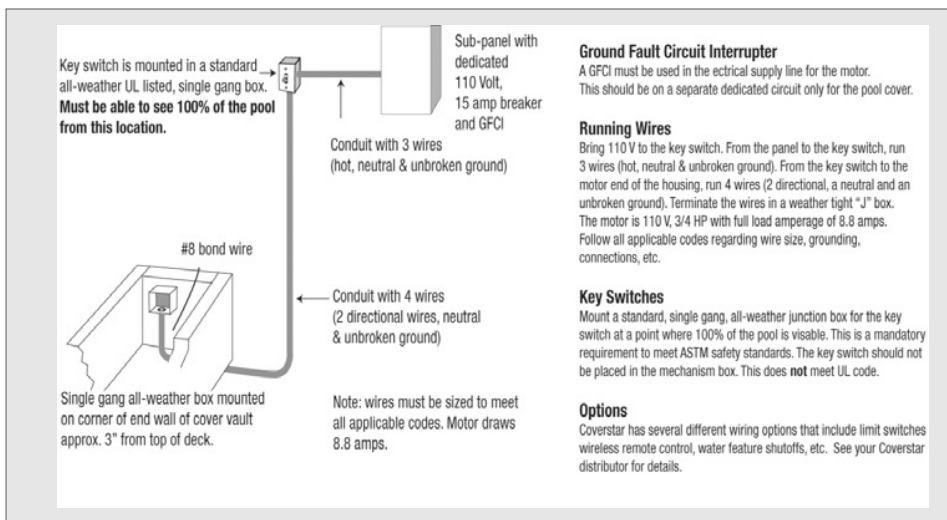

### Wiring The Electrical Switch

The control switch must be mounted in an all weather box, in a location where 100% of the pool is visible. Connect the control switch according to the diagram below.

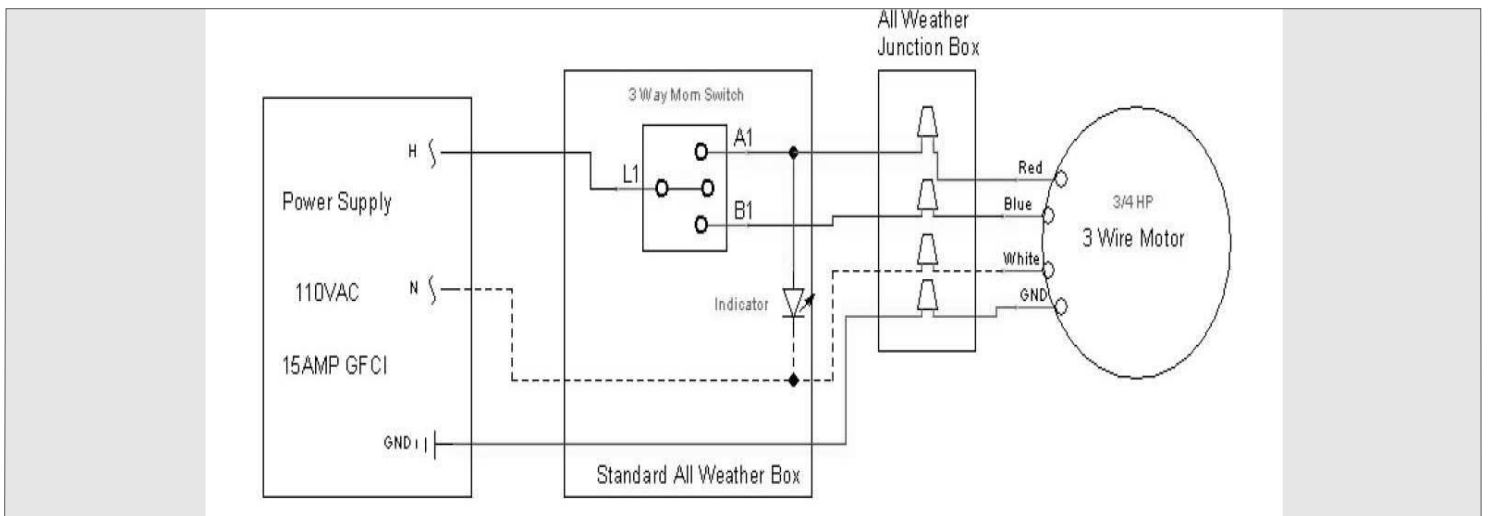

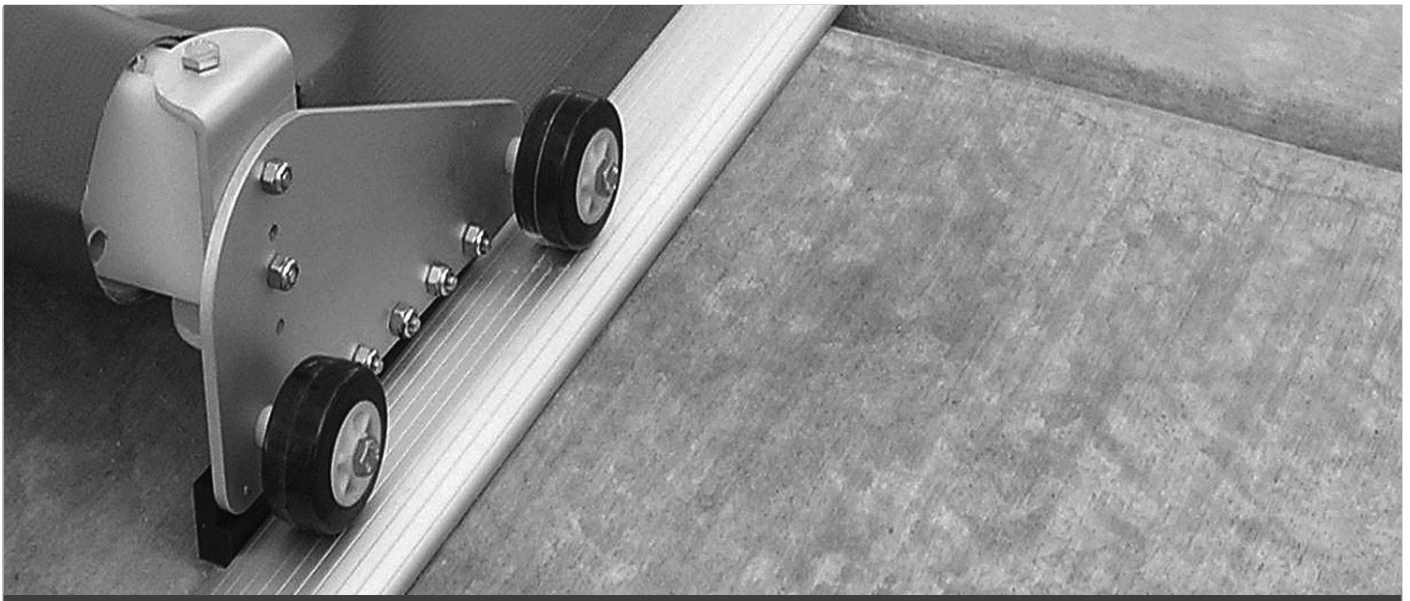

## COVER FABRIC

Step by Step Instructions	Page/Step
Opening the cover .....	12/1
Unrolling the cover .....	12/2
Running ropes through the tracks .....	12/3
Routing the ropes.....	12/9
Attaching the cover leading edge .....	13/15
Attaching the ropes to the rope reel .....	15/28
Running the cover over the pool .....	15/30
Attaching the cover and bonding wire .....	15/31
Adjusting the ropes .....	15/34
Adjusting the torque limiter.....	16/37
Adjusting the brakes .....	16/40

(Numbers in parenthesis refer to hardware on page #3)

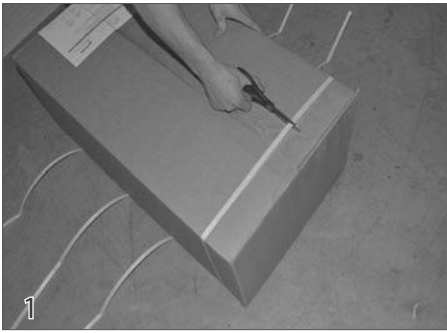

### Opening The Cover

To open the cover box, cut the bands that hold the two halves of the box together. Never cut the top of the box open. Doing this could easily damage the cover inside. This kind of damage is not covered under the fabric warranty. With the bands cut, lift and remove the top box.



### Unrolling The Cover

Standing behind the housing looking over the pool, unroll the cover from left to right.

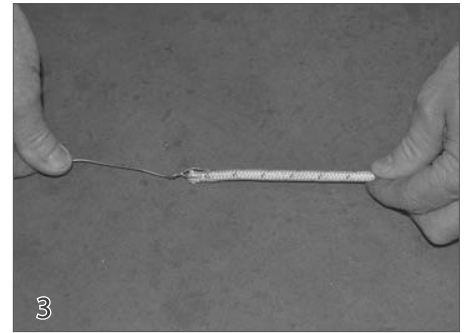

### Running Ropes Through The Tracks

The preferred method of running the rope is to pierce the rope with a 1' length of wire and use it as a handle to feed the rope through the track.

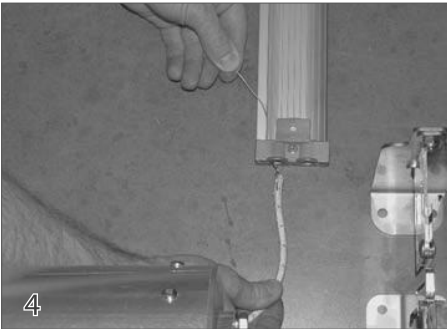

Feed the rope into the water side channel of the track with the wire extending out the side of the track. Use the wire to pull the rope down the length of the track towards the end of the pool.

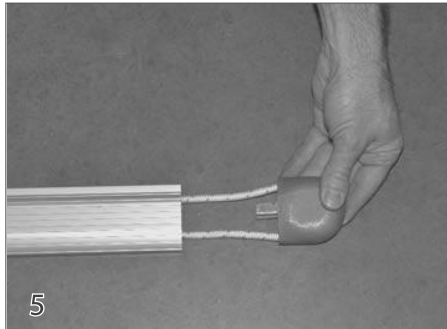

Feed the rope through the pulley assembly (17) and insert the pulley housing into the end of the track.



Feed the rope into the back channel then pull the rope down the back side of the track toward the cover housing.

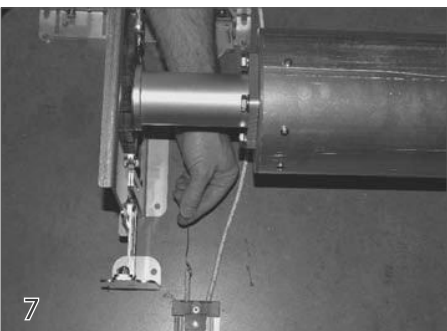

Pull all excess rope through the cover track.



Complete the fastening of all track screws flush to the top of the track. Clean concrete dust from track and pulley end cap. Make sure ALL screws are flush with the top of the tracks.

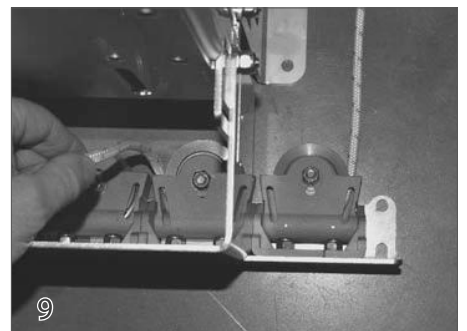

### Routing the Ropes

Begin with the rope on the motor end. Feed the wire that is attached to the rope around the first and second pulleys.

## Installation Guide

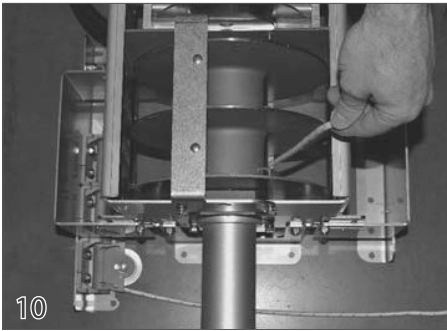

10 Direct this rope under the rope reel, over the rope containment bracket and out of the mechanism.

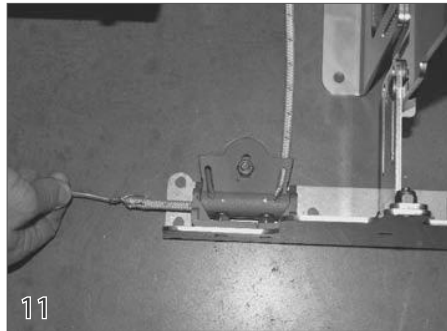

11 On the non-motor end, feed the wire that is attached to the rope around the pulley and out the back channel of the pulley assembly. Pull this rope to the motor end pulley assembly.

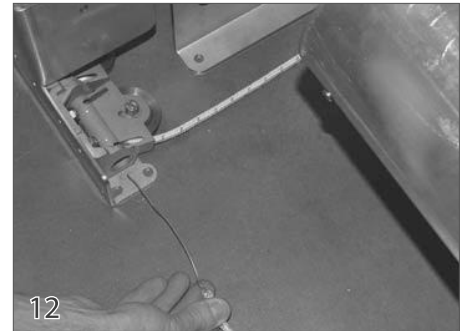

12 Insert the wire that is attached to the rope into the channel behind the first pulley. Continue to push the wire until it comes out of the channel behind the third pulley.



13 Bend a curve into the end of the wire and pull it back just until it is in the middle of the pulley. Now push the wire back until it comes out the side of the third pulley.

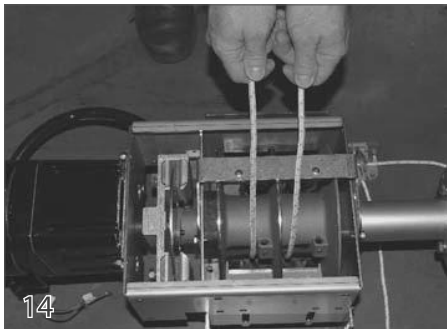

14 Pull the rope under the rope reel, over the rope containment bracket and out of the mechanism.



### Attaching The Cover Leading Edge

Lay the front of the cover in front of the mechanism. Slide the leading edge through the loop on the front of the cover.



16 Attach the detachable rope tab to the three hole plate on the wheel assembly.



17 Place the nylon leading edge inserts into the ends of the leading edge tube. Make sure they can slide freely inside the leading edge tube.



18 Connect the two hole bracket that is attached to the front corners of the cover to the wheel assemblies.

## Step By Step Instructions

(Numbers in parenthesis refer to hardware on page #3)

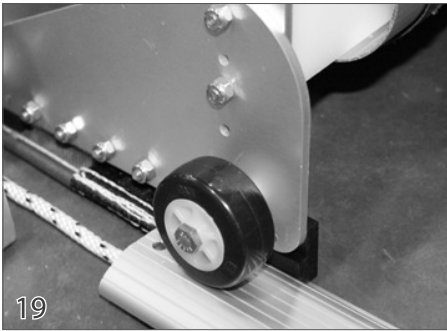

Feed the wheel assembly (8) and cover into the track.



Place a guide feed (14) over the end of the track and drill  $3/16$  hole through the hole in the guide feed and through the track.

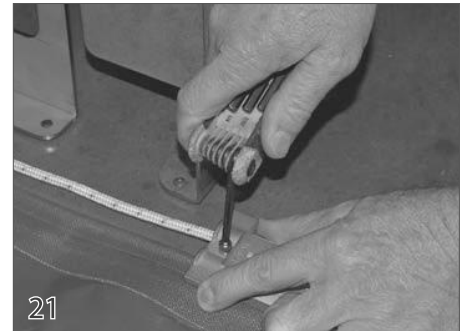

Use a  $5/32$  allen wrench to tighten the screw that connects the two sections of guide feed together.



Install a stop on the end of the track near the mechanism to keep the cover from retracting too far. Secure the stop to the deck using the screws (15) and anchors (25) provided. Run the key switch in the uncover position to roll the cover up on the roll-up tube. Check the cover to be sure it rolls up evenly.



Place a bonding lug (16) on top of the guide feed. Insert a  $10-32 \times 1 \frac{5}{8}$  screw (34) through the lug, guide feed, and track. Install a  $10-32$  nylock nut (21) and tighten with a  $3/8$ " wrench.

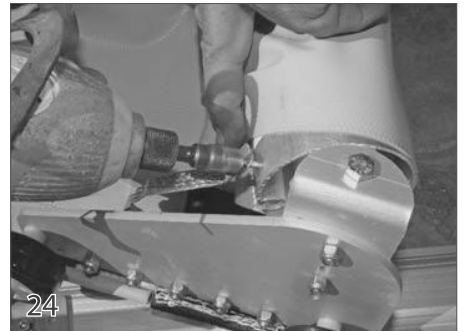

Connect the bonding wire that is attached to the front corner of the cover to the leading edge bar using a tek screw. Be sure the screw doesn't interfere with the leading edge insert.



Position the fabric on the leading edge so it is in line with the leading edge support bracket. Secure with a tek screw (24) on the back side of the leading edge. Be sure the screw does not interfere with the leading edge insert.



Pull the cover back until the cover is in the tracks equally on both sides. Pull the ropes tight as they come off the pulleys on the mechanism to eliminate the slack in the rope.



Pull both ropes until the leading edge just moves on each side, cut the longer rope to the same length as the shorter rope while tight. These ropes should be at least 8ft long. Use a lighter or torch to burn the ends of the rope. In most cases you will only need to cut one rope.

## Installation Guide



28

**Attaching The Ropes to the Rope Reel**  
Loosen the set screw and remove plastic plug from the rope holder tube. Bring the ropes back to the mechanism. Attach the ropes to the rope reel by inserting the ropes through the center of the rope holding tube and tighten the set screws firmly into the ropes. Some prefer to tie a knot at the end of the rope.



29

While holding the ropes over the mechanism, run the key switch in the cover position. The excess rope will be wrapped around the rope reel.



30

**Running The Cover Over The Pool**  
Run the cover over the pool being careful to prevent it from binding in the guide feeds by lifting the cover and helping it into each track the first time.



31

### Attaching The Cover & Bonding Wire

At the motor end, attach the tail of the cover and the bonding wire to the roll-up tube using 1/2" tek screws (24). Make sure the webbing continues straight as it travels from the track to the roll-up tube. Attach the cover and bonding wire to the roll-up tube on the



32

The first two screws need to be 3" from the end of the tube. Distribute the slack of the cover evenly across the length of the tube. Secure the cover to the roll-up tube using tek screws every 2-3ft. When attaching the cover to the tube, do not use folds or pleats. Operate the cover 6-10 times to make sure it is opening and closing squarely.

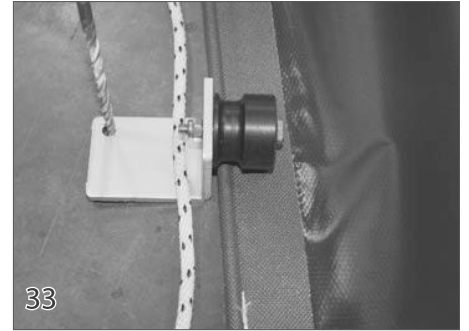

33

To help the cover roll up evenly, install a cover roller (37) 2-3 inches behind the guide feed. Secure the cover roller to the deck using the screws (15) and anchors (25) provided.

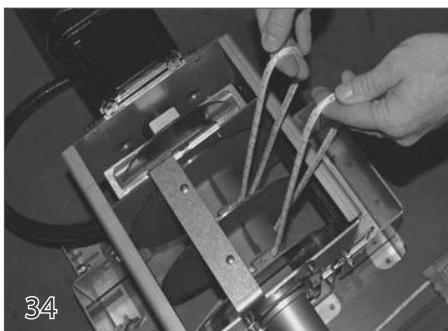

34

### Adjusting the Ropes

When closing the cover, if both sides of the cover don't close squarely, one of the ropes may need to be adjusted. To adjust the rope, open the cover all the way. Pull the excess rope off the rope reel.



35

If one of the ropes is longer than the other rope, loosen the set screw that secures the rope to the rope reel lug. Shorten this rope until it is the same length as the other rope. Re-attach the rope to the rope reel.

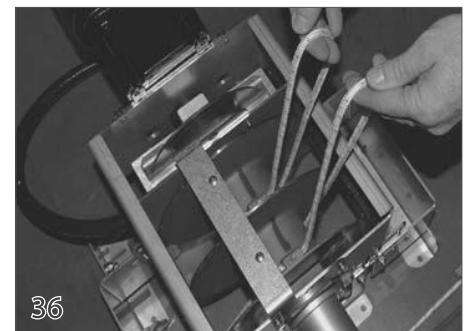

36

If both ropes are the same length, and the cover doesn't close squarely, shorten the rope for the side of the cover that doesn't close all the way. The amount that the rope is shortened is equal to the amount distance that the cover needed to travel to close all the way. While holding the rope, run the switch in the cover position.

(Numbers in parenthesis refer to hardware on page #3)

## Step By Step Instructions

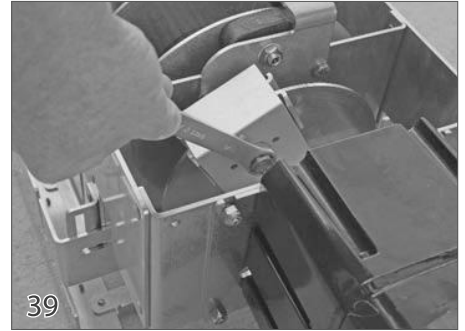
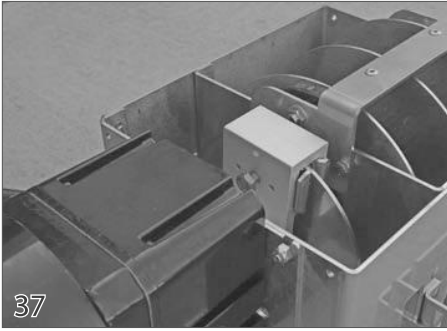

### Adjusting The Torque Limiter

The Eclipse Automatic Cover System is equipped with a torque limiter that helps prevent damage to the mechanism. Only if the motorized mechanism does not extend or retract the cover will you need to adjust the torque limiter.

To adjust the torque limiter, use the provided 9/16" wrench attached to the mechanism to tighten the first brake bolt 1/2 turn. Run the cover.

If further adjustment is needed, rotate the torque limiter brake arm to position the second brake bolt and tighten the second brake bolt 1/2 turn.

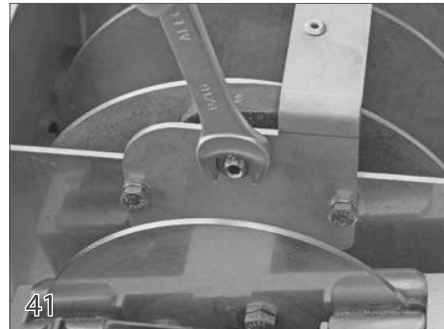

### Adjusting The Brakes

There is a brake at the motor and non-motor end of the mechanism. The brakes are preset at the factory and should work properly. If they do not, they should be tightened enough to prevent the rope from spooling off the reel as the cover is opening. There should only be enough drag to keep the reel and roll up tube from free spinning.

If you need to adjust the rope reel brake, first loosen the jamb nut on the side of the rope reel mechanism.

To tighten the brake, use an allen wrench to turn the set screw inside the jam nut in the clockwise direction.

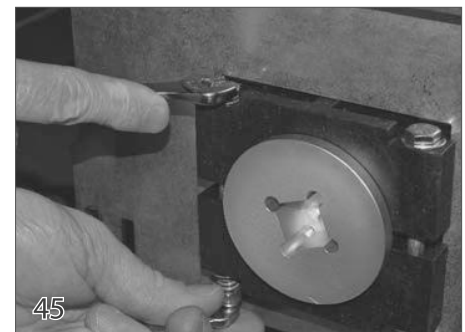

To loosen the brake, use an allen wrench to turn the set screw inside the jam nut in the counter clockwise direction.

After adjusting the set screw, retighten the jamb nut while holding the set screw with an allen wrench. There's a corresponding brake on the opposite side of the rope reel. Adjust both brakes equally.

The roll up tube brake on the non motor end should be tight enough to prevent the cover from rolling off the tube faster than it is being pulled into the track. To adjust this brake, use two 7/16" wrenches and tightening or loosening the thru bolts in the brake block.





## HOME OWNER CHECKLIST

After the cover system is installed, it is critically important to instruct the home owner on how to operate the cover system safely and do routine maintenance. Use the following check list and the ECLIPSE Use & Care Guide as your primary instruction source.

### Use & Care Guide Page

- How to use the cover pump .....4
- How to uncover and cover the pool .....6-7
- Warn about standing water on the cover .....4
- Who is authorized to operate the cover system.... 6
- Pool chemicals and cover life .....8
- Proper maintenance and care of the cover system8-9
- Inform the customer on pool safety .....Back cover

## Installation Checklist

### Tracks

- Does the track space measurement match how the cover system was ordered?
- All track ends filed. This is extremely important
- Cover goes through the track joints smoothly.
- All track screws are tight and flush.
- Pulleys are flush against the end of the track.
- The guide feeds are snug against the track
- Guide feeds bolted in and are tight.
- Stops installed.
- Alignment pins and splices used when joining the tracks, even in encapsulation.

### Mechanism

- Mechanism installed level in the box.
- Tube level
- Tube centered between the tracks.
- Enough clearance top, bottom, sides for the fabric. No rubbing of webbing on sides or bottom of box.
- Tube at the right height? The ideal location is to install the cover in the box so that the cover is coming off at as small an angle as possible. This reduces stress on the mechanism and reduces wear on cover tracks at the end of the track.
- Tube either centered in the bench
- System mounted at right angle to the track.
- Ropes coming back straight out of the track. An excessive angle will cause wear on the cover tracks at the end of the track.
- Ropes are not rubbing on any brackets or the deck.
- Ropes are run correctly (see page 13, steps 11-18).
- 8 feet of rope left on rope reel.
- System bonded according to electrical code. Cover bonded to leading edge and roll-up tube.
- Torque limiter adjusted for the pool (see page 16, steps 37-39). If mechanism is hydraulic, are both bypass valves set slightly higher than necessary to run the cover?
- Rope loops installed on each lid bracket so rope cannot droop and snag on cover or lid brackets (see page 20, step 3)
- Make sure the system is electrically bonded to meet the National Electrical Code.

### Cover

- Fabric pinned to the take-up tube without pinned folds.
- Cover is bolted to the wheel assembly.
- Cover runs smoothly.
- Cover properly aligned when it closes or retracts. Note: An inch or two out of square is not uncommon and is not a concern as it will not effect the operation of the cover. Because of the size of the fabric roll, and changes in operating conditions the cover may vary slightly in alignment as it is run.
- The leading edge inserts move in and out freely the whole length of the pool.
- Fabric is pinned to the leading edge flush with the ends of the tube.

### Misc.

- Key switch is in full view of the pool
- Cover pump tested by putting it in the water and operate it in front of homeowner
- The cover box is clean and clear of debris so that the drains are not easily clogged
- Pool area cleaned up
- Homeowner has been instructed (see page 17)

# QUESTIONS?

For questions about this installation guide,  
contact your independent Coverstar distributor.



COVERSTAR, INC, 1795 West 200 North Lindon, UT 84042

© 2007 Coverstar, Inc.  
Date: June 2016 Ver: 3.2



L9784