

**Guaranteed
Installation Price**
Call for Details

Original
Endless Pool
Planning Guide

October 2009



EASIER TO INSTALL, MORE EFFICIENT TO OPERATE

Featuring a series of design and manufacturing innovations, our newest Endless Pool® is even easier to install. Incorporating some of the latest technology from the spa industry, our computerized water quality system includes push button poolside controls and a filter that can be changed from in the pool. Since so many of our customers enjoyed deeper water we now offer 6" and 12" deeper models that require no additional site preparation.

Designed for easy installation

The modular Endless Pool has been engineered for ease of installation. Pre-wired and pre-plumbed, all components fit easily through any doorway and down stairs for simple assembly.

Minimal site preparation

A solid, level surface and a 30 amp electric service is all you need. While you may want to finish off the space with elaborate tile and deck up to the pool for a built-in look, a Factory Trained Installer can install the Endless Pool with nothing but an empty space at least two feet wider and three feet longer than the inside dimensions of the pool.

Guaranteed Installation Pricing

Our network of independent Factory Trained Installers can have you swimming in a couple of days at a guaranteed price. The installation of an Endless Pool is that simple.

Complete package includes everything but the water

The Endless Pool is a complete system that includes the pool plus a water quality system located at the front of the pool to heat, filter and purify the water, a swim current generator and return channels. Popular options include wider, longer, and deeper models, retractable security covers, interior steps/seats, exterior stairs, synthetic skirting, and underwater lights at the front.

Super energy efficient

The Endless Pool provides all the benefits of a full-sized pool in a very small space. The small size means far less water to heat. Our 1/8th horsepower electric circulating pump uses less energy than a 120 watt light and is virtually silent. Our pre-plumbed 4 kW electric heater uses the same circuit as the 5 hp hydraulic power unit. Every Endless Pool comes with an insulating thermal blanket to retain heat and trap humidity. While our optional retractable security covers retains heat and traps humidity while additionally serving as lockable safety covers.

Three easy steps to swim at home

1. Shoot digital photographs of your proposed location for review by our Design Professionals. If you think access to your site might be an issue, photograph that narrow set of stairs or other condition for our review. Generally, if you can get a 4' x 8' sheet of plywood to the location where the Endless Pool is to be installed we can get all the components in. Also photograph your electric panel and indicate where the panel is in relationship to the proposed location of your Endless Pool. Email these photographs to our Design Professionals.
2. Place a refundable deposit, receive your "Welcome Kit" detailing finish choices, log on to your personal online order form and configure your pool. If you would like one of our Factory Trained Installers to visit your site to confirm and clarify any of these installation details please call us to make an appointment. Naturally, you are always welcome to visit our showroom near the Philadelphia Airport. We have five pools ready to use.
3. Complete your online order form by making your size and color choices. Then finalize your order and schedule your installation.

4 NOTABLE ENDLESS POOL FEATURES

1. **There is no connection to household plumbing.** You fill the pool with a garden hose and change the water every year or two. The pool is equipped with a closed-loop plumbing system that automatically pumps water out of the pool, passes the water through a filter, heater and copper/silver purification system, and returns it to the pool.
2. **100% of the humidity can be controlled** when the pool is not in use, by either the optional automatic or manual security cover. When closed, the cover seals in humidity and reduces heat loss. The cover has a lock-down mechanism for security. The humidity present from a daily one-hour swim can be controlled by a simple room dehumidifier or a bathroom exhaust fan.
3. **We have greatly reduced chlorine** odor and effects with our modern purification system that comes standard with every pool. Your home will not smell like the local gym!
4. **Should you decide to relocate your pool, it can be unbolted and moved.** Give us a call and we will explain what is involved in relocating a pool.

HOW AN ENDLESS POOL WORKS

The heart of the Endless Pool is a small but powerful underwater hydraulic motor that drives a 16" propeller located at the front of the pool inside a protective housing. The propeller pushes water through two grills that straighten and smooth the current, which then flows right down the center of the pool. This current is completely variable in speed and controlled by a handy remote. The speed can be adjusted from a gentle flow to a sprinter's pace.

At the rear of the pool, the current enters a large grill beneath the rear bench, and passes through the side channels to the front of the pool. Because the water returns through the side channels, it does not disturb the current moving down the center of the pool, thus eliminating any turbulence.

Specifications:

- 7' x 14' swimming area
- 39" water depth, 42" wall height
- Acrylic water propulsion system
- 5 hp swim current generator
- Digital systems control
- High efficiency circulating pump
- Skimmer filter (removable cartridge type)
- 4 kW electric heater
- Solar cover

Options:

- Size: 7' x 12' to 10' x 16' swimming area
- Depth: 45" or 51" (48" or 54" panel height)
- Interior corner steps/seats
- Interior raised rear bench (48" and 54" models only)
- Internal pool surface: 3 colors, 4 patterns available
- Manual and automatic retractable security covers, available in 5 colors
- Underwater lights
- Hydrotherapy jets
- Hi-Performance 6 hp swim current generator
- Front and floor swim mirrors
- 9 3/4" wide perimeter coping system (5 colors)
- Aluminum coping for outdoor installations
- Exterior stairs
- Digital swim pace display
- Wood or synthetic skirting on 2, 3 or 4 sides
- Floor leveling system with stainless steel tension straps

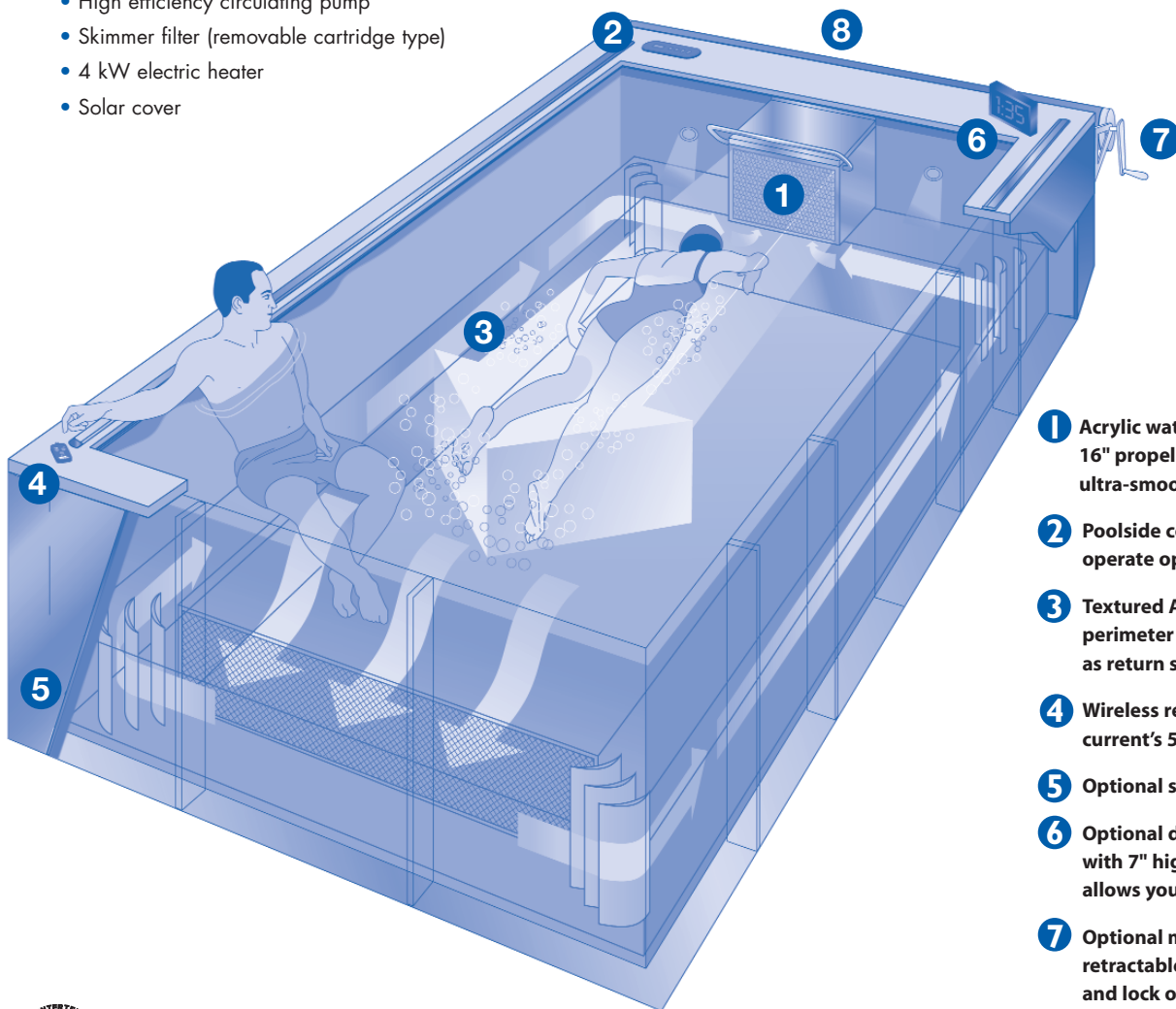

- 1** Acrylic water propulsion system with 16" propeller produces broad, deep, ultra-smooth current
- 2** Poolside controls adjust heat and operate optional jets and lights
- 3** Textured ABS return channels serve as perimeter seating (42" pools) as well as return system for water flow
- 4** Wireless remote controls the swim current's 52 preprogrammed speeds
- 5** Optional skirting
- 6** Optional digital swim pace display with 7" high-visibility, LED display allows you to see your swim pace
- 7** Optional manual or automatic retractable security covers lock in heat and lock out dirt and debris
- 8** Computerized water quality system mounted on the front panel



LOCATING YOUR ENDLESS POOL®

The unique modular design of the Endless Pool allows the pool to be located indoors or outdoors, aboveground or in-ground, in an existing ground floor room or in a new space. Some typical locations are shown in the illustration below.

An Endless Pool fits just about anywhere. All you need is a solid, near-level surface capable of supporting the weight. Indoors, a concrete floor is perfect. If you want to sink the pool into the floor, a near-level bottom to an excavated hole is sufficient. Typically, rather than excavating, it is easier to build a deck up around the pool to make the Endless Pool appear built-in. Outdoors any hardscape surface is fine. Erecting the pool on compacted soil is what is important. If it is easy to pour a four inch concrete pad, then that is the best solution. If concrete is difficult to bring in, then bags of readily available “pool base” (vermiculite and cement) mixed by hand in a small mixer is by far the easiest solution and more than sufficient to support the 200 lbs./square foot loading for a regular Endless Pool model and 260 lbs./square foot for a deeper model.

First identify and measure a location that is 24" wider and 36" longer than the inside dimensions of the Endless Pool model you select. For our standard Endless Pool an area 9'-0" x 17'-0" is perfect. Be sure you consider drainage when selecting a site.

Next, determine what size and depth pool you want. Our standard 42" high Endless Pool is ideal for swimming and seated water exercises on the perimeter return channels. Our optional 48" pool can also accommodate many therapy and aquatic exercise routines, as can our deepest 54" unit. Remember taller pools stand higher in the room and ceiling height can be an issue.

A small percentage of our customers opt to make a custom deeper pool by providing a multi-level concrete base for the pool. Depths up to six feet are available using this technique. Please call for additional technical information.

PUT A POOL IN A BASEMENT OR A GARAGE?

At first glance, a basement or a garage may seem like an unusual place to swim. But many of our customers have discovered that existing ground floor spaces offer excellent locations for an Endless Pool.

Basements

- A basement provides a winterized, accessible, year-round space.
- Concrete-floor basements offer the ideal structural support for an aboveground pool.
- The Endless Pool can be installed freestanding and above ground. The pool stands 42" (1.07 m) high. It can fit easily in a room with a ceiling height as low as 7' (2.13 m). There is no need to break through the floor. Even our 48" and 54" high pools offering deeper water are freestanding. They can be made to appear partially in-ground by decking up around them.

Garages

- An Endless Pool fits easily in half of a two-car garage.
- The pool can be installed against a wall or in a corner. Access to the sides of the pool following installation is not required except to any panels where optional lights or jets are located.
- Since the Endless Pool can be well insulated with rigid foam and an optional security cover, the garage need not be heated.
- Even garage floors with a significant slope can be accommodated with our optional floor leveling system.

	INDOORS	OUTDOORS		INDOORS	OUTDOORS
Existing Space	<ul style="list-style-type: none"> • Basement • Garage • Family Room • Other Ground Floor Room • Home Gym 	<ul style="list-style-type: none"> • Deck • Patio • Carport • Porch (enclosed now or later) • Garden 	New Space	<ul style="list-style-type: none"> • Refinished Basement • Converted Garage • Sunroom • Greenhouse • Master Bathroom Suite 	<ul style="list-style-type: none"> • New Landscaping • New Outdoor Space (with possible future enclosure)

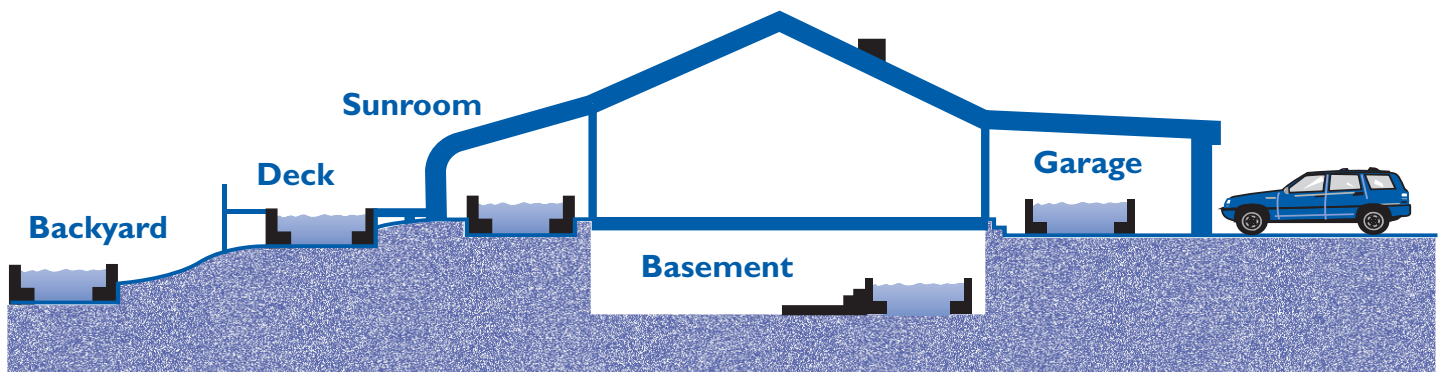

EQUIPMENT PLACEMENT AND ACCESS?

The Endless Pool has two closed loop systems: the Water Quality System and the hydraulic drive system. Both can be powered by a single 30 amp, 220 volt, GFCI circuit. Have your electrician supply the appropriate disconnect and we will take it from there.

Equipment Placement

The equipment to filter and heat your Endless Pool is typically installed at the front of the pool just below the coping. The keypad controller for this system has a 10 foot cord and is usually mounted in the pool coping. When optional hydrotherapy jets are selected, the jets are plumbed into the rear wall over the bench and the jet's pump is located at the front pool panel and plugs into the heater/controller. The radio controlled 5 horse-power Hydraulic Power Unit is usually located near your electric service. It requires a single 30 amp, 220 volt, GFCI service. A flexible conduit connects this power unit to the heater/controller poolside. Hydraulic lines connect between the front of the pool and the power unit. Up to 25' of hydraulic line is provided with the pool. Additional hydraulic line may be ordered when locating the power unit further away. These lines will run against a wall or, if you wish, through 4 inch PVC pipe. If using pipe as conduit you must sweep all turns, no 90° bends.

For fully in-ground installations where the pool is backfilled and the equipment is kept at the front, a pit needs to be built at the front of the pool. A sump for water removal is prudent with this configuration.

Equipment Access

All of the water quality equipment is located at the front—the end towards which you swim. Customers frequently place their Endless Pool directly against a wall or in a corner. We recommend that the front end not be installed against a wall. The rear—the end opposite the swim current generator—may be against a wall. Be sure to leave enough room to turn the handle of the retractable security cover which is often mounted off the end of the pool.

If hydrotherapy jets are selected be sure to leave two feet of access outside the pool where the jets will be located. Optional underwater lights are installed on the front panel on each side of the swim unit, where access is guaranteed. (The lights may also be installed on either of the long walls of the pool with the understanding that access to the outside must be maintained.)

The outside dimensions of the Endless Pool depend on the coping system chosen. For indoor pools our synthetic coping system is 9-3/4" wide at the rear and on either side. At the front, the coping is an extra 4" wider covering the pool equipment which mounts on the outside of the front wall. Access is required to this front wall. This is why we require a space three feet longer and two feet wider than the inside dimensions of the pool you choose.

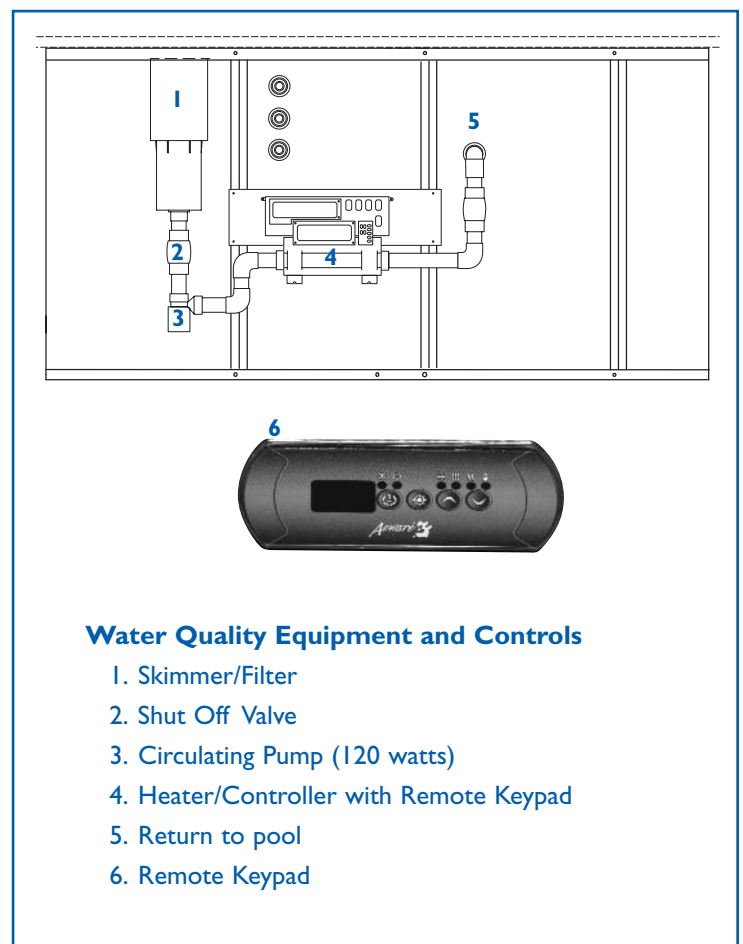
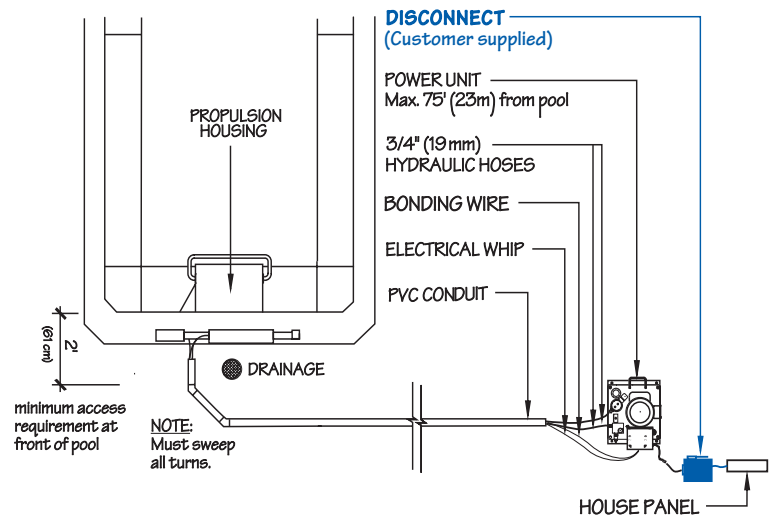

Permitting

We recommend asking your electrician to install the shut-off at your house panel stating that you are putting in a “modular, transportable spa” rather than a pool. Since the Endless Pool can be installed without anchors into the floor it is truly transportable and is often not considered a permanent pool. This fact has significant permit ramifications. In many municipalities no permit is required for a transportable spa.

DEPTH AND ACCESSIBILITY

The Endless Pool® offers many features to make it accessible to all users. Different sizes and depths are available. The interior water return channels serve as steps into and out of the pool. The pool walls can function as a handrail or the top edge of the walls — the coping — as a seat. In addition, water powered lifts, grab bars and steps are also available.

Based on the height of pool you choose and the configuration of your room, consider how you will access the pool. Customers frequently deck up around the pool to reduce the apparent height of the pool in the room. We offer a variety of stair systems as well as handrails and grab bars. Finally, water powered lifts are available for special access needs and/or when space is tight. Inside the pool, steps in any of the corners is possible.

The easiest and most cost effective way to install and access the Endless Pool is on a flat slab on grade. A small set of stairs allows you to step up and sit on the perimeter coping and to swing your legs over — into the pool. Stepping down into the pool is then quite easy. This is the easiest way to enjoy your pool.

To add an extra dimension, once the pool is installed, build a small deck up around the pool leaving the top 24" to 30" exposed. You can then stand on your deck and access the pool by sitting on the coping, swinging your legs over, and stepping down in. If you dig down to achieve this look you can backfill to the panels and finish the surround as desired.

If a fully in-ground look is desired, decking is again the most cost effective solution. Once the pool is installed, construct a deck to the desired elevation. Remember that access is required to the front panel. If you plan to excavate and sink the pool into the ground, you can back fill to the panels but a pit must be constructed 3 feet deep and 2 feet 6 inches out from the front panel for equipment access. See diagram below.

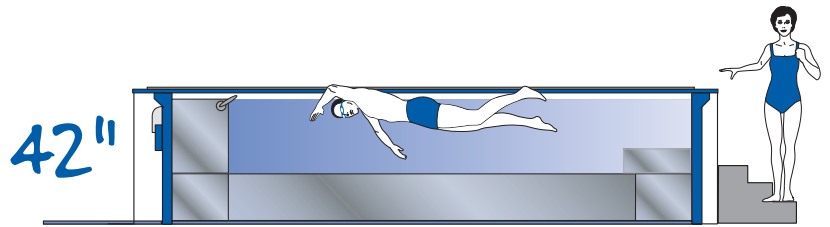

Aboveground Endless Pool

The simplest, most cost effective way to install an Endless Pool is aboveground on a solid, level surface. A 42" tall aboveground unit is easily accessed with a set of stairs.

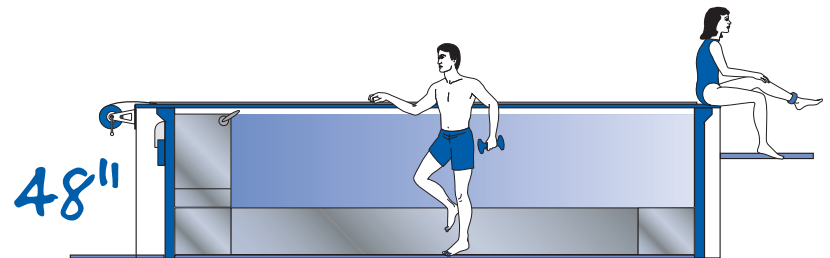

Partially In-ground Effect

The in-ground effect may be created without excavation by building decking around a pool installed aboveground. Alternatively, a pit may be excavated and the pool installed partially in-ground. The edge of the pool serves as a comfortable seat.

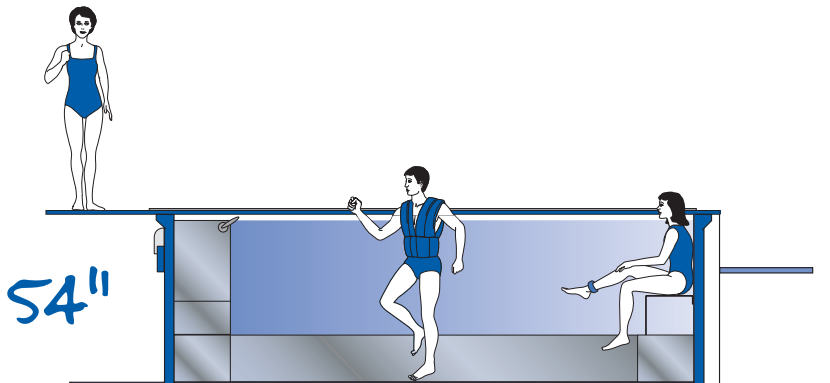

Fully In-ground Effect

Less common but quite elegant, a fully in-ground effect can also be created with decking up around an aboveground pool. Excavation, while increasing the cost and complexity of the job, can also be undertaken.

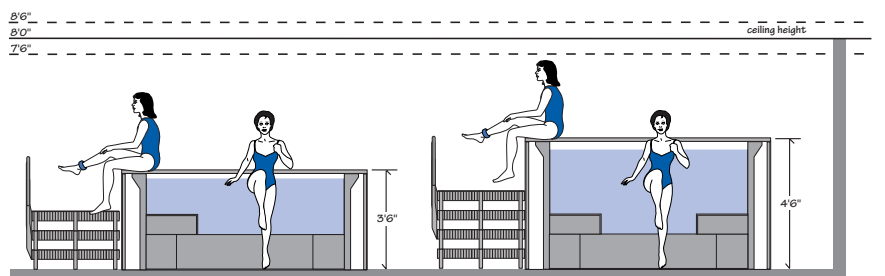
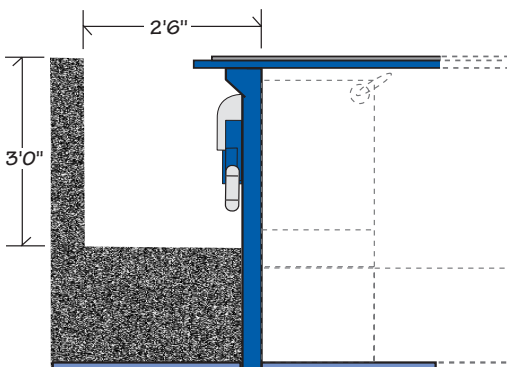

AVAILABLE SIZES

In addition to optional deeper pools, the flexible design of the Endless Pool® permits a variety of sizes. When deciding upon a length and width for your pool, you should consider such factors as how you intend to use your pool, the general dimensions of the site, your own height, and additional space requirements for options such as jets.

The standard Endless Pool has inside dimensions (water surface area) of 7' x 14' (2.13 m x 4.26 m) and is suitable for most applications. The standard pool can be made 1' (.30 m) or 2' (.61 m) shorter. Shorter pools are appropriate when space is tight. These shorter pools offer the same swim as the standard pool.

Wider and/or longer pools are appropriate when a number of people plan to use the pool at the same time, or if the user is very tall and swims with a wide frog kick that may touch the side benches of the standard Endless Pool. A standard 42" Endless Pool can be made up to 3' (.91 m) wider and 2' (.61 m) longer. Our 48" model can be made up to 2' wider and 2' longer and the 54" model can be made up to 3' wider and 1' longer.

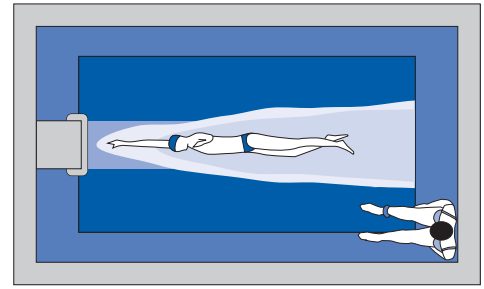

8' x 14'

2.43 m x 4.26 m

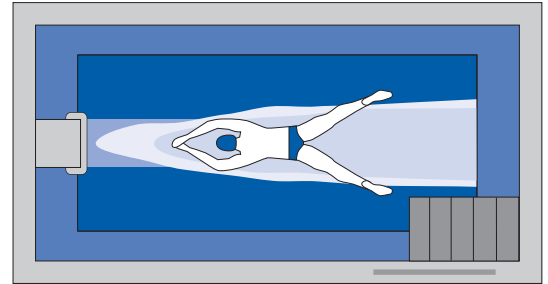

8' x 16'

2.43 m x 4.87 m

Standard Size: 7' x 14' (inside dimensions)

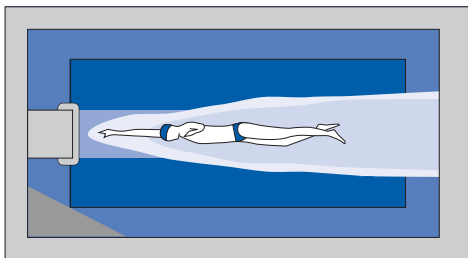

7' x 14'

2.13 m x 4.26 m

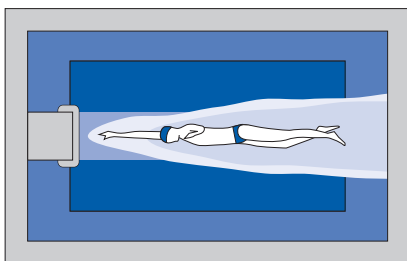

7' x 12'

2.13 m x 3.65 m

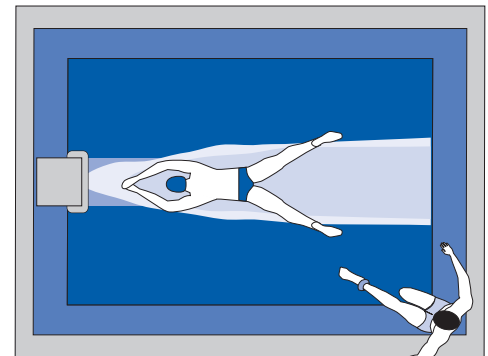

10' x 14'

3.05 m x 4.26 m

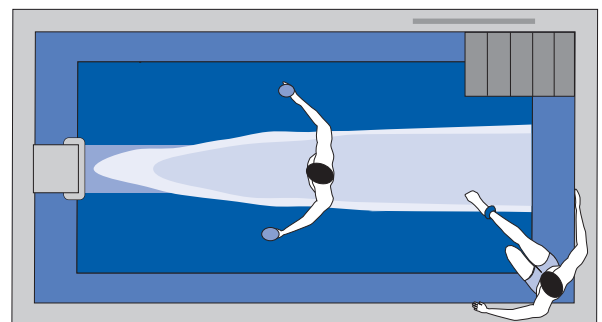

9' x 16'

2.74 m x 4.87 m

Call 1-800-732-8660 for a FREE Test Swim.

Swim...

Call Endless Pools for the demonstration pool nearest you, or visit our factory showroom, just 15 minutes from the Philadelphia airport, 3 miles off I-95. Our factory is located between Rt. 352 and Rt. 452 on Dutton Mill Road overlooking Chester Creek. Showroom hours are 8:00 am to 5:00 pm Monday through Friday, and weekends by appointment. Please call to schedule a visit and a swim.



Endless Pools, Inc.
1601 Dutton Mill Rd
Aston, PA 19014-2831
www.endlesspools.com
swim@endlesspools.com

800.732.8660 US
610.497.8676 Local
610.497.9328 Fax



CONTROLLING COSTS

The cost of installing an Endless Pool® varies considerably depending on the type of installation and the construction around the pool. With the modular Endless Pool system and our network of Factory Trained Installers (FTIs), we have taken the guesswork out of the cost of pool installation. To minimize your overall project costs, please consider:

- ✓ **Select an existing site and be swimming in days.**
The Endless Pool is designed for easy installation in an existing room. The need for a separate equipment room has been eliminated. Our new, state-of-the-art electronic equipment package is located at the front of the pool, behind the skirting.
- ✓ **Above ground installations – even with deeper pools.**
The Endless Pool is free standing, perfect for an above ground installation. Above ground installations are usually less expensive than partially or completely in-ground installations. Decking up around a finished pool makes it appear built in. Optional 48" or 54" panels provide deeper water without the need to pour an elaborate concrete pit.

- ✓ **Use standard finishes**
Endless Pools can provide finished synthetic coping and skirting. These standard finishes allow our expert installers to have your pool completely finished before they leave – the only decision you need to make is what bathing suit to wear.

- ✓ **Energy efficiency means you'll save money!**
The Endless Pool is designed for efficiency. Substantially less water to heat and keep clean means less energy used. A floating thermal cover reduces heat loss and controls humidity. Our super efficient circulating pump uses less energy to run than a 120 watt bulb.

- ✓ **Expert installation at a GUARANTEED PRICE!**
Our network of independent Factory Trained Installers can have you swimming in a couple of days. All you need is a flat, level surface 3' longer and 2' wider than the pool you select. Services may be restricted in some areas. Call for details.