

# SPA & HOT TUB STEP

## Assembly Instructions

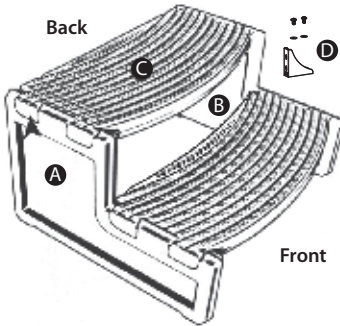

### Components

- A: Left Support
- B: Right Support
- C: Step Tread
- D: Tread support brackets, screws, washers and hex key

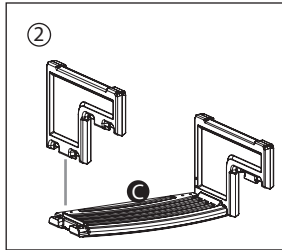
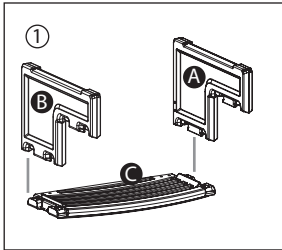

### Step 1 & 2

Place supports (A and B) parallel to each other on a level surface (with Life logo facing outwards) approximately 70 cm apart. Take step tread (C) and place it in position by inserting first the front clips and then clicking the back clips into place.

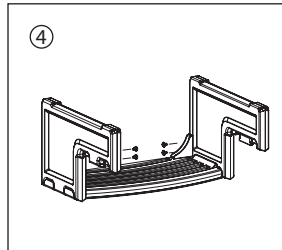
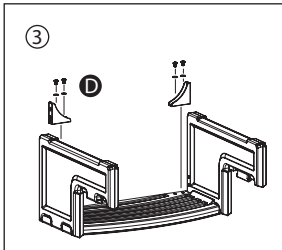

### Step 3 & 4

Place bracket into position (D). Attach the bracket using the screws and washers supplied. Make sure all screws are securely fastened.

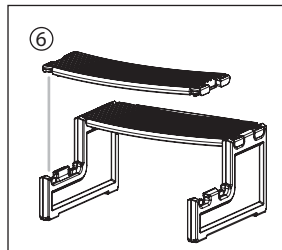
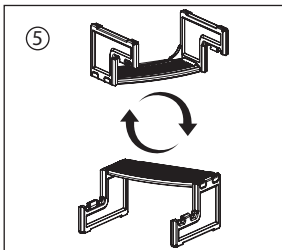

### Step 5

Turn the step over.

### Step 6

Position the bottom step tread in place. Position the front clips in place and then click the back clips into place.