

	1	2	3	4	5	6	7	8
	Pool Height							
	1.2m							
A	1.5m							

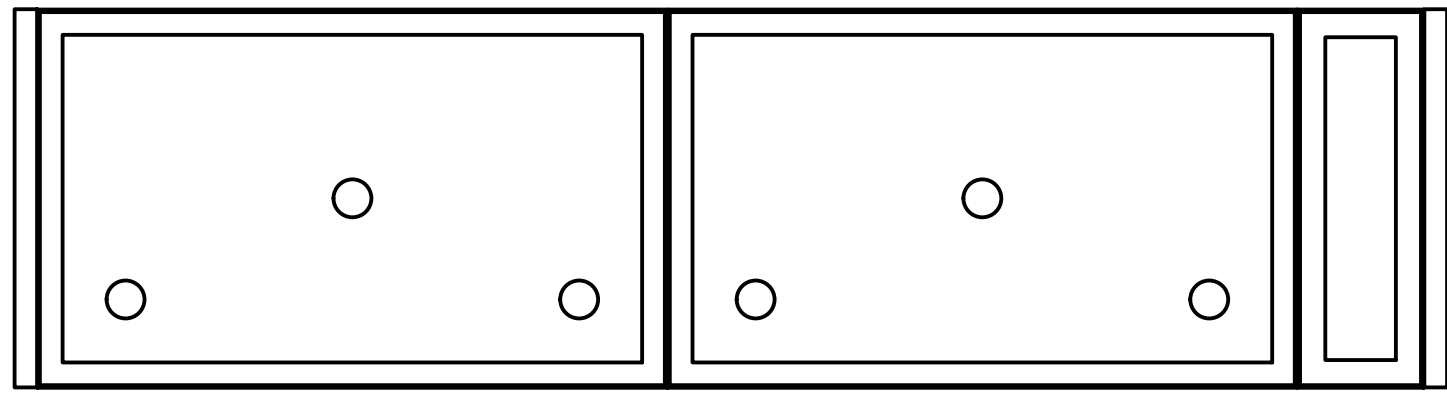

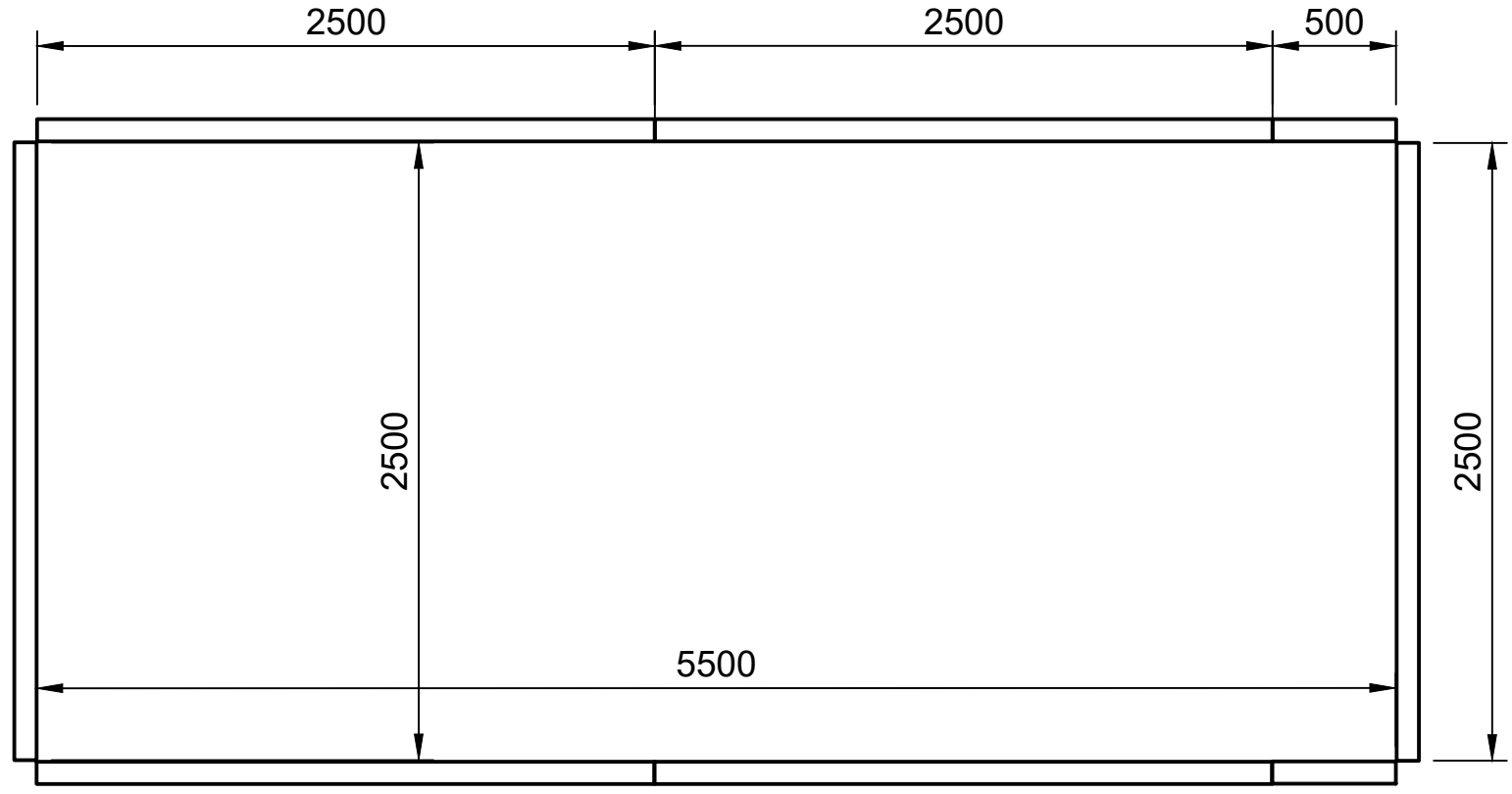
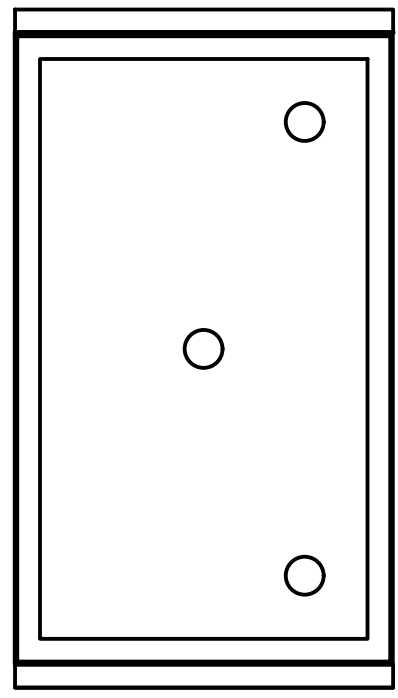

Notes :

- Please confirm skimmer / fitting locations.
- Please indicate which pool wall height you require.

<u>Signed Approval:</u>	<u>Date Required:</u>

1. Plan not to scale.
2. Due to the manufacturing process the main body of the pool can vary up to +/-2cm.
3. Please sign and return the plan layout to enable the pool to be put into the order schedule.

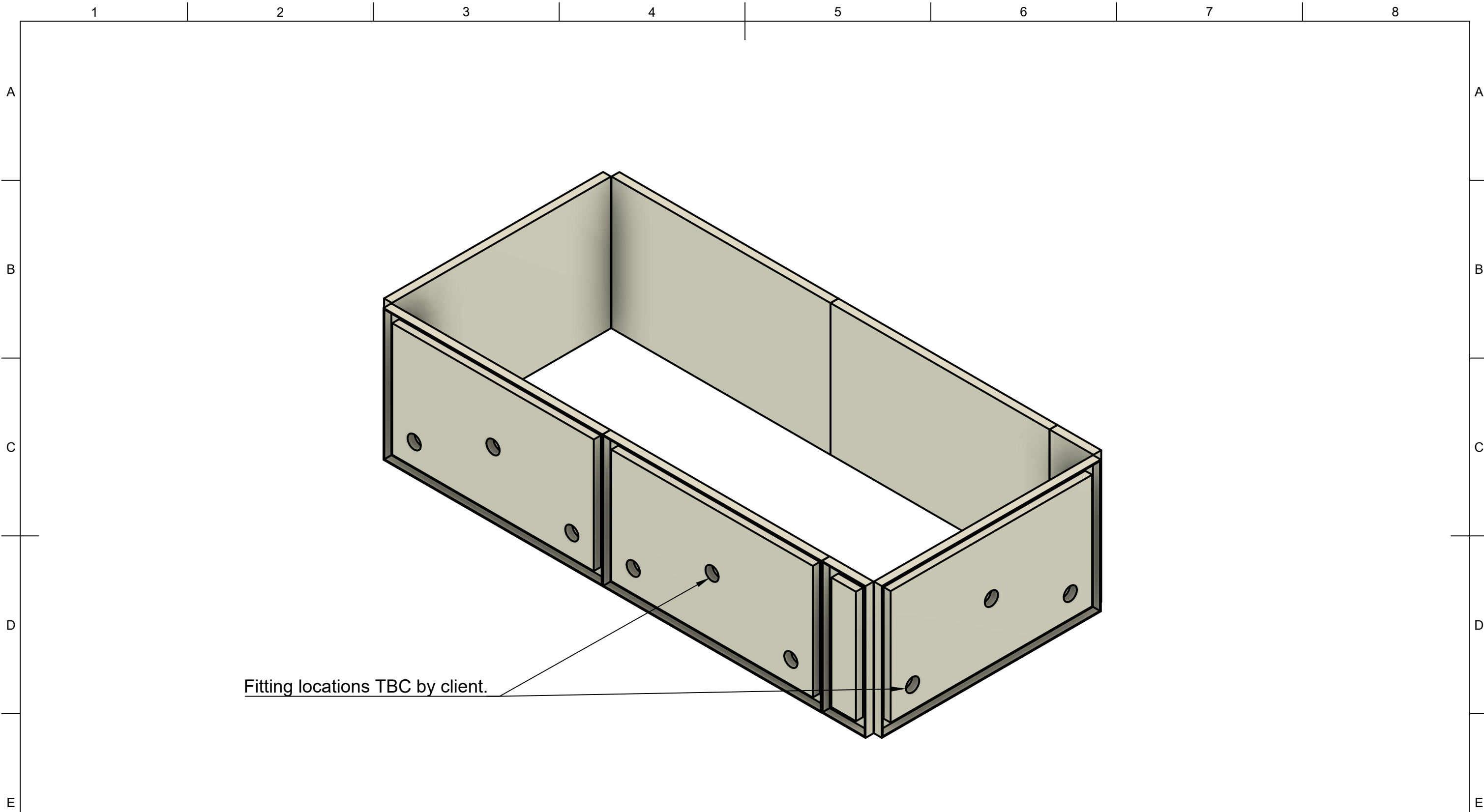

Dept. Design	Technical reference LT / JW	Created by Luke Taylor 20/01/2021	Approved by
 		Pool Specification 5.5 x 2.5m	Document status For INFORMATION
		Client Reference AllSwim 5.5 x 2.5m Pool	DWG No. HF_003_5.5x2.5_AS_03
Rev.	Date of issue	Sheet	
01	20/01/2021	1/2	



Fitting locations TBC by client.

Signed Approval:	Date Required:

1. Plan not to scale.
2. Due to the manufacturing process the main body of the pool can vary up to +/-2cm.
3. Please sign and return the plan layout to enable the pool to be put into the order schedule.

Dept. Design	Technical reference LT / JW	Created by Luke Taylor 20/01/2021	Approved by
 		Pool Specification 5.5 x 2.5m	Document status For INFORMATION
		Client Reference AllSwim 5.5 x 2.5m Pool	DWG No. HF_003_5.5x2.5_AS_03
Rev. 01	Date of issue 20/01/2021	Sheet 2/2	