

User manual

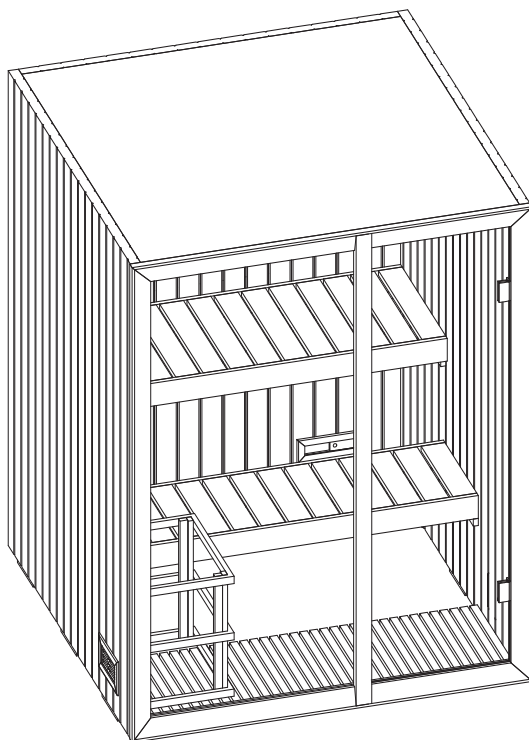

EN

DE

FR

IT

Element sauna

Onni sauna (1-053-080)

Table of Contents

1. About this instruction manual	3
2. Product description	4
2.1. Technical data	4
2.2. Floor plan	4
2.3. Scope of delivery	5
2.4. Parts list	6
3. Preparation for assembly	7
3.1. Tools required	7
3.2. Maintenance and cleaning	8
3.3. Disposal	8
4. Illustrations for assembling the cabin	9

1. About this instruction manual

Read these installation and operating instructions carefully and keep them within reach of the infrared cabin. This ensures that you can refer to information on safety and operation at any time.



These installation and operating instructions can also be found in the downloads section of our website: www.sentiotec.com/downloads.

Important note:

- Before you begin work, check the parts list to ensure that all the individual parts have been delivered. If you discover any missing parts, notify your dealer within 14 days of receiving the sauna cabin.
- The room that the sauna is installed in must be dry and ensure an appropriate amount of air circulation.
- The floor must be level and even, preferably a stone or tiled floor.
- A minimum room height of 230 cm is required for the cabin installation work.
- A distance of at least 5 cm from the wall must be maintained.
- The inside of the wooden parts used must not be handled with any impregnating material.
- You need an assistant for the installation.
- Wood is a natural product that can swell, shrink or warp, despite good storage. For this reason, some force may be necessary during the installation.

All screw fittings must be pre-drilled.

Attention!

The electrical connection may only be performed by a qualified electrician or similarly qualified person.

2. Product description

2.1. Technical data

Cabin material	Abachi
Cabin dimensions (L x W (depth) x H)	1600 x 1600 x 2000 mm
Recommended heating output	7,5 – 9 kW

2.2. Floor plan

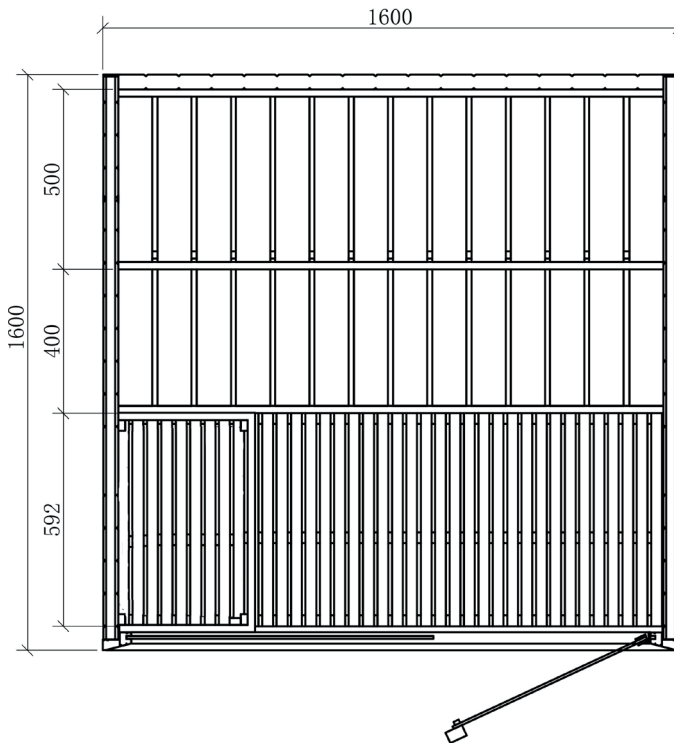

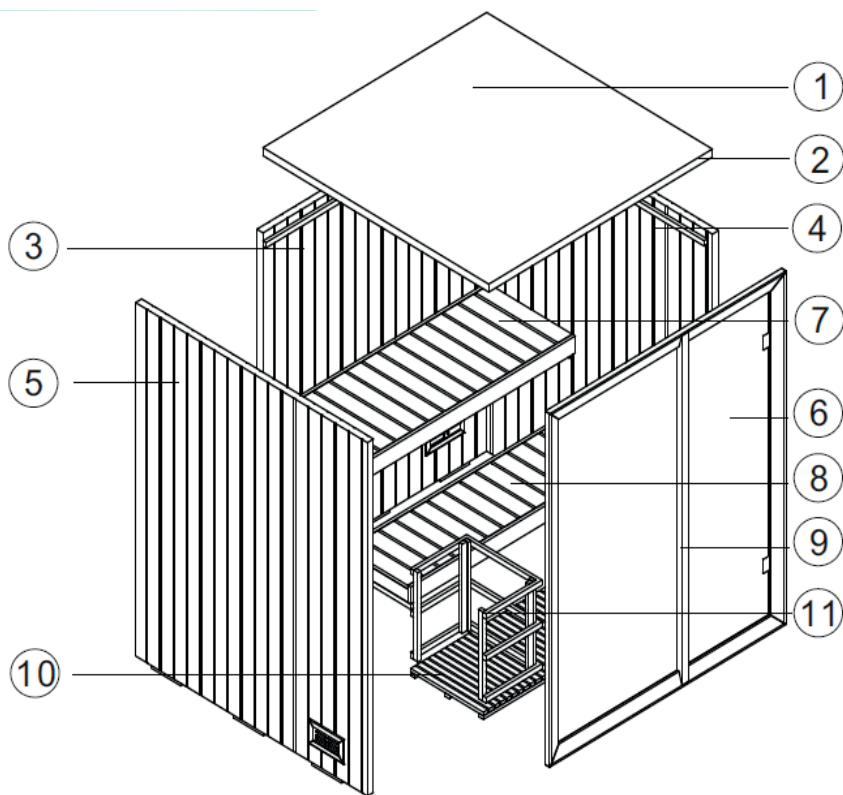

2.3. Scope of delivery



2.4. Parts list

No.	NAME	DIMENSIONS	PIECES
1	Cover, roof element	1504 x 1504 x 5 mm	1
2	Roof element	1504 x 1504 x 63 mm	1
3	Rear wall	1507 x 2000 x 56 mm	1
4	Right side wall	1570 x 2000 x 46 mm	1
5	Left side wall	1570 x 2000 x 46 mm	1
6	Glass front	1600 x 2000 x 67 mm	1
7	Upper bench	1505 x 500 x 95 mm	2
8	Lower bench	1505 x 500 x 95 mm	1
9	Door handle	1960 x 80 x 32 mm	1
10	Floor grid	1505 x 650 x 60 mm	1
11	Heater protection grille	580 x 420 x 500 mm	1
12	Sauna lamp		1
13	Lamp protection grille		1

Installation material

		
Φ 4 x 35	Φ 4 x 45	Φ 4 x 35
12 pcs.	22 pcs.	6 pcs.

3. Preparation for assembly

Before you begin work, check the parts list to ensure that all the individual parts have been delivered. If you discover any missing parts, notify your dealer within 14 days of receiving the sauna cabin. Button



You need an assistant for assembly.
We also advise you to pre-drill the holes for the screws.



Check the right angle:

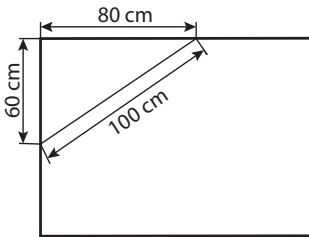

Handle glass with care: Special care must be taken with the edges of the glass – hardened glass can shatter into small pieces in the event of impact. Insert protective cushioning (e.g. cardboard box) under the edge of the glass.

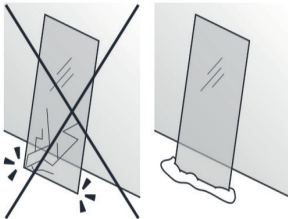

3.1. Tools required



Screwdriver



Tape measure



Drill



Twist drill



Utility knife



Spirit level



Pencil



Step ladder

3.2. Maintenance and cleaning

- The sauna should be cleaned with a damp cloth. Only use warm water – no cleaning products.
- We recommend heating the cabin once a month if the sauna is not used for a long time.

3.3. Disposal



Dispose of packaging materials in accordance with the applicable waste disposal regulations.

4. Illustrations for assembling the cabin

You will find the illustrations after the last language

Benutzerhandbuch

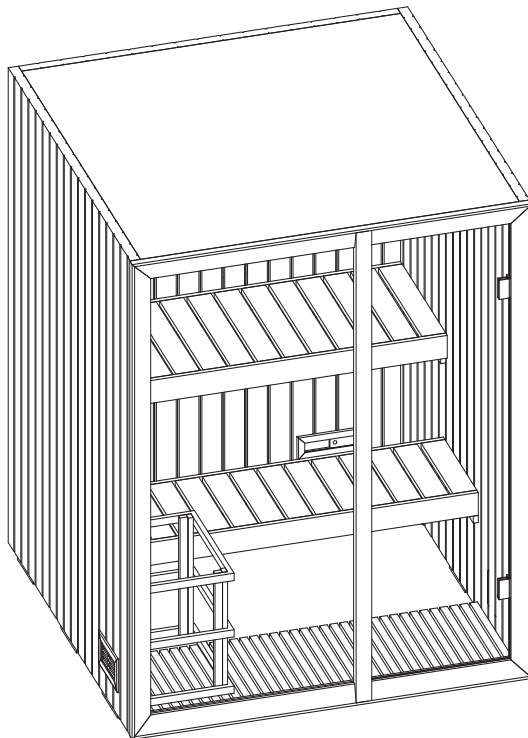

DE

Elementsauna

Onni Sauna (1-053-080)

Inhaltsverzeichnis

1. Zu dieser Anleitung	3
2. Produktbeschreibung	4
2.1. Technische Daten.....	4
2.2. Grundriss.....	4
2.3. Lieferumfang.....	5
2.4. Stückliste.....	6
3. Montagevorbereitung	7
3.1. Benötigtes Werkzeug.....	7
3.2. Wartung und Reinigung.....	8
3.3. Entsorgung.....	8
4. Montage Kabine Abbildungen	9

1. Zu dieser Anleitung

Lesen Sie diese Montage- und Gebrauchsanweisung gut durch und bewahren Sie sie in der Nähe der Infrarotkabine auf. So können Sie jederzeit Informationen zu Ihrer Sicherheit und zur Bedienung nachlesen.



Sie finden diese Montage- und Gebrauchsanweisung auch im Downloadbereich unserer Webseite auf www.sentiotec.com/downloads.

Wichtige Hinweise:

- Kontrollieren Sie, bevor Sie mit der Arbeit beginnen, anhand der Stückliste, ob alle Einzelteile auch tatsächlich mitgeliefert wurden. Sollten Einzelteile ausnahmsweise fehlen, benachrichtigen Sie spätestens 14 Tage nach Erhalt der Kabine Ihren Händler.
- Der Raum, in dem die Saunakabine montiert wird, muss trocken sein und eine entsprechende Luftzirkulation gewährleisten.
- Der Fußboden muss waagrecht und eben sein, bevorzugt Stein- oder Fliesenboden.
- Für die Montagearbeiten der Kabine wird eine Mindestraumhöhe von 230 cm benötigt.
- Es muss ein Wandabstand von mindestens 5 cm eingehalten werden.
- Die Innen zu verwendenden Holzteile dürfen nicht mit Imprägniermittel behandelt werden.
- Für die Montage benötigen Sie einen Helfer.
- Holz ist ein Naturprodukt, das trotz guter Lagerung aufquellen, schwinden oder sich verziehen kann. Aus diesem Grund kann es vorkommen, dass bei der Montage etwas Kraft aufgebracht werden muss.

Alle Verschraubungen müssen vorgebohrt werden.

Achtung!

Der Elektroanschluss darf nur durch eine Elektrofachkraft oder eine vergleichsweise qualifizierte Person ausgeführt werden.

2. Produktbeschreibung

2.1. Technische Daten

Kabinenmaterial	Abachi
Kabinenmaße (L x B (Tiefe) x H)	1600 x 1600 x 2000 mm
Empfohlene Ofenheizleistung	7,5 - 9 kW

2.2. Grundriss

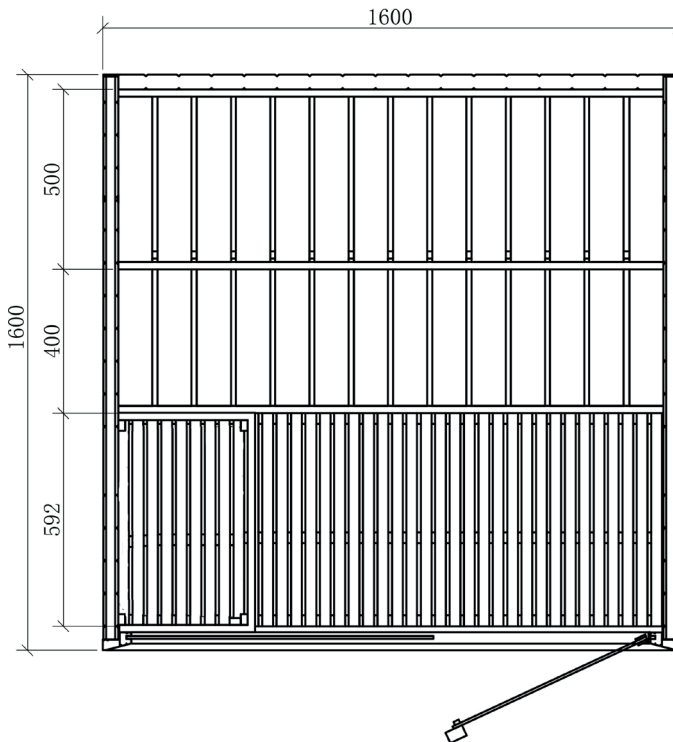

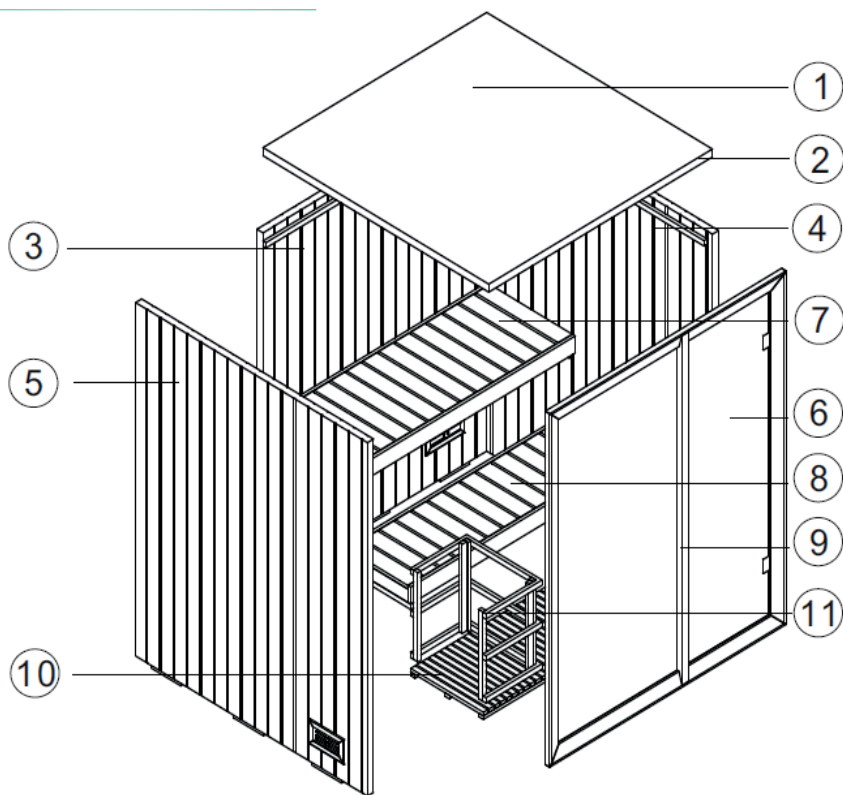

2.3. Lieferumfang



2.4. Stückliste

Nr.	NAME	ABMESSUNGEN	STÜCK
1	Abdeckung Dachelement	1504 x 1504 x 5mm	1
2	Dachelement	1504 x 1504 x 63mm	1
3	Rückwand	1507 x 2000 x 56mm	1
4	Rechte Seitenwand	1570 x 2000 x 46mm	1
5	Linke Seitenwand	1570 x 2000 x 46mm	1
6	Glas Front	1600 x 2000 x 67mm	1
7	Obere Bank	1505 x 500 x 95mm	2
8	Untere Bank	1505 x 500 x 95mm	1
9	Türgriff	1960 x 80 x 32mm	1
10	Bodenrost	1505 x 650 x 60mm	1
11	Ofenschutzgitter	580 x 420 x 500mm	1
12	Saunaleuchte		1
13	Lampenschutzgitter		1

Montagematerial

		
Φ 4 x 35	Φ 4 x 45	Φ 4 x 35
12 Stk.	22 Stk.	6 Stk.

3. Montagevorbereitung

Kontrollieren Sie, bevor Sie mit der Arbeit beginnen, anhand der Stückliste, ob alle Einzelteile auch tatsächlich mitgeliefert wurden. Sollten Einzelteile ausnahmsweise fehlen, benachrichtigen Sie spätestens 14 Tage nach Erhalt der Kabine Ihren Händler. Taste

 Für die Montage benötigen Sie einen Helfer!
Weiters empfehlen wir die Löcher für die Schrauben vorzubohren.



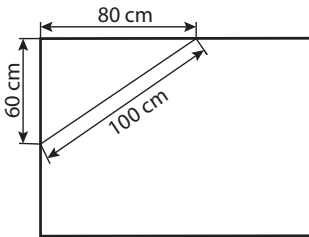



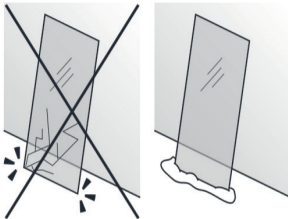

 Überprüfung des rechten Winkel:



 Vorsichtiger Umgang mit Glas: Besondere Vorsicht gilt den Glaskanten - Gehärtetes Glas kann bei Stößen in kleine Scherben zerspringen. Legen Sie ein Schutzpolster (z.Bsp.: Verpackungs-Karton) unter die Glaskante.



3.1. Benötigtes Werkzeug

- | | | | | | |
|---|-----------------------|---|-----------|---|--------------|
|  | Schraubendreher (Kit) |  | Bandmaß |  | Bohrmaschine |
|  | Spiralbohrer (Kit) |  | Cutter |  | Stehleiter |
|  | Wasserwaage |  | Bleistift | | |

DE

3.2. Wartung und Reinigung

- Die Sauna sollte mit einem feuchten Tuch gereinigt werden. Verwenden Sie nur warmes Wasser - keine Reinigungsmittel.
- Wird die Sauna längere Zeit nicht benutzt, empfehlen wir, die Kabine einmal im Monat aufzuheizen.

3.3. Entsorgung



Entsorgen Sie die Verpackungsmaterialien nach den gültigen Entsorgungsrichtlinien.



4. Montage Kabine Abbildungen

Die Abbildungen finden Sie nach der letzten Sprachen

Manuel d'utilisateur

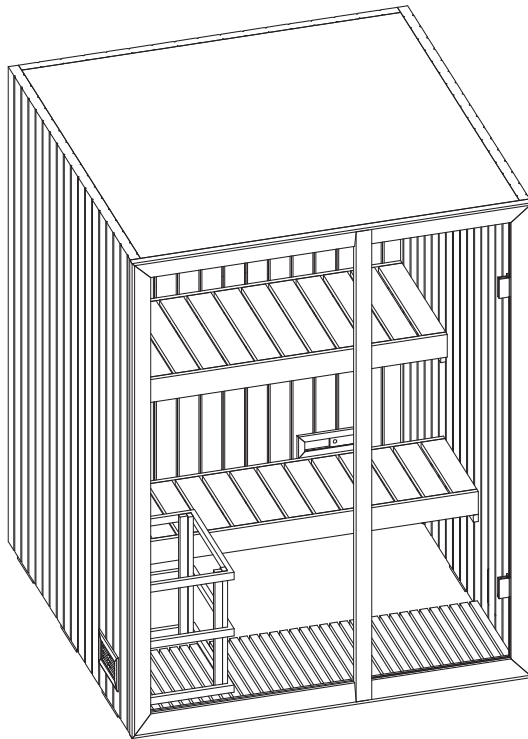

FR

Sauna à base d'éléments

Sauna Onni (1-053-080)

Table des matières

1. Concernant ces instructions	3
2. Description du produit	4
2.1. Caractéristiques techniques	4
2.2. Plan	4
2.3. Contenu de la livraison	5
2.4. Nomenclature	6
3. Préparation du montage	7
3.1. Outils requis	7
3.2. Entretien et nettoyage	8
3.3. Élimination	8
4. Illustrations de montage de la cabine	9

1. Concernant ces instructions

Lisez attentivement ces instructions de montage et ce mode d'emploi et conservez-les à proximité de la cabine infrarouge. Vous pouvez ainsi consulter à tout moment des informations concernant son utilisation et relatives à votre sécurité.



Ces instructions de montage et ce mode d'emploi sont également disponibles dans la zone de téléchargement de notre site Internet www.sentiotec.com/downloads.

Remarques importantes :

- Avant de commencer les travaux, vérifiez au moyen de la nomenclature si toutes les pièces ont bien été livrées. S'il devait s'avérer que des pièces manquent, informez votre revendeur dans les 14 jours suivant la réception de la cabine.
- La pièce dans laquelle la cabine de sauna va être montée doit être sèche et disposer d'une circulation suffisante de l'air.
- Le sol doit être horizontal et lisse, de préférence en pierre ou carrelage.
- Pour les travaux de montage de la cabine, la pièce doit faire au moins 230 cm de haut.
- Une distance d'au moins 5 cm avec le mur doit être respecté.
- Les pièces en bois prévues pour l'intérieur ne doivent pas être traitées avec un agent d'imprégnation.
- Une deuxième personne doit être disponible pour vous aider.
- Malgré un stockage correct, le bois est un produit naturel qui peut gonfler, se contracter ou se déformer. C'est pourquoi il peut arriver que vous ayez à appliquer de la force lors du montage.

Tous les raccords vissés doivent être préalésés.

Attention !

Seul un électricien spécialisé ou une personne ayant une qualification similaire est habilité à procéder au raccordement électrique.

2. Description du produit

2.1. Caractéristiques techniques

Matériau de la cabine	Abachi
Dimensions de la cabine (L x l (profondeur) x h)	1600 x 1600 x 2000 mm
Puissance de chauffage recommandée	7,5 - 9 kW

2.2. Plan

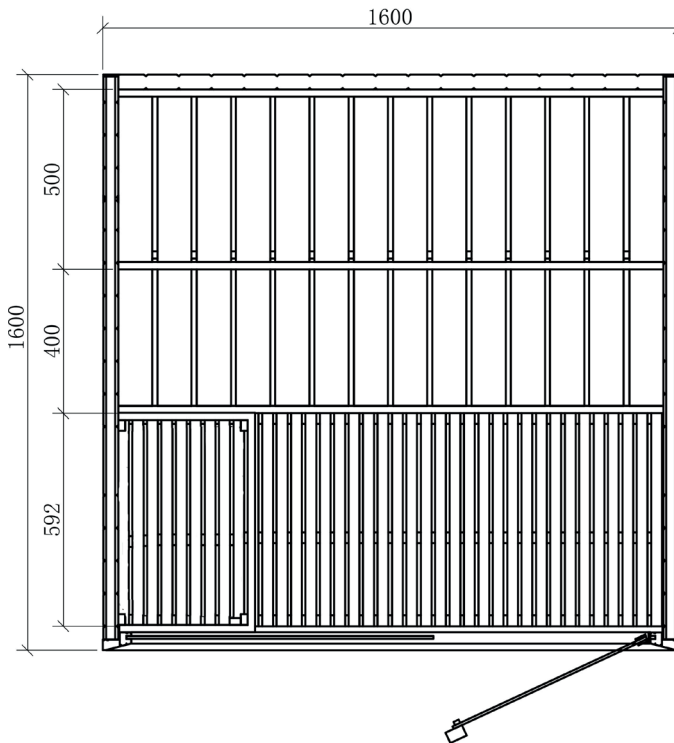

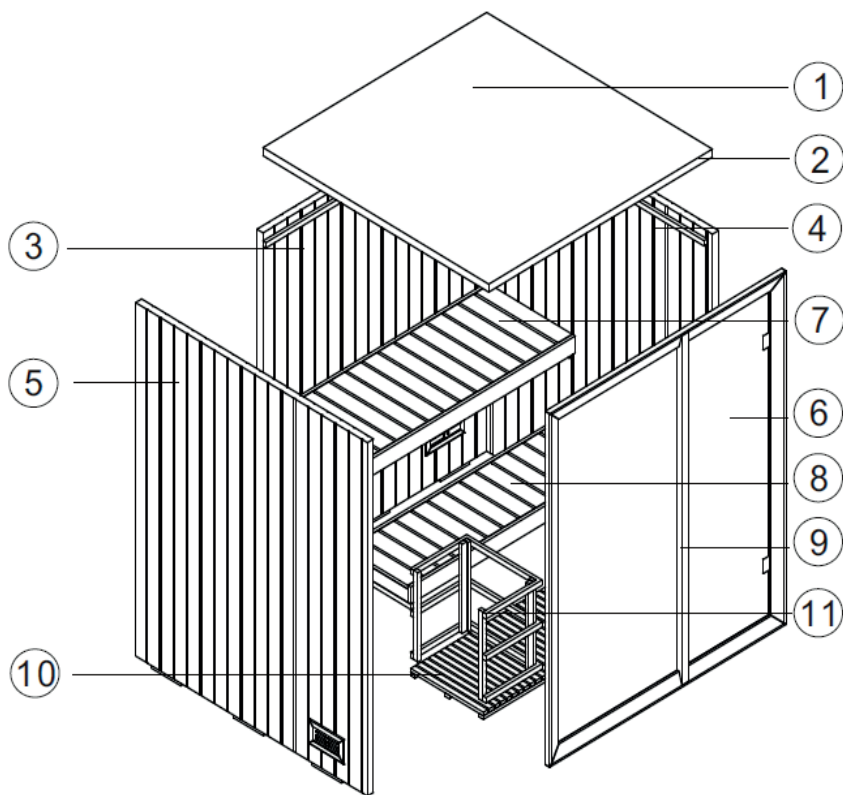

2.3. Contenu de la livraison



2.4. Nomenclature

N°	NOM	DIMENSIONS	PIÈCES
1	Cache d'élément de toit	1504 x 1504 x 5 mm	1
2	Élément de toit	1504 x 1504 x 63 mm	1
3	Paroi arrière	1507 x 2000 x 56 mm	1
4	Paroi latérale droite	1570 x 2000 x 46 mm	1
5	Paroi latérale gauche	1570 x 2000 x 46 mm	1
6	Façade vitrée	1600 x 2000 x 67 mm	1
7	Banc supérieur	1505 x 500 x 95 mm	2
8	Banc inférieur	1505 x 500 x 95 mm	1
9	Poignée de porte	1960 x 80 x 32 mm	1
10	Grille de plancher	1505 x 650 x 60 mm	1
11	Grilles de protection de poêle	580 x 420 x 500 mm	1
12	Éclairage de sauna		1
13	Grille de plancher		

Matériel de montage

		
Φ 4 x 35	Φ 4 x 45	Φ 4 x 35
12	22	6

3. Préparation du montage

Avant de commencer les travaux, vérifiez au moyen de la nomenclature si toutes les pièces ont bien été livrées. S'il devait s'avérer que des pièces manquent, informez votre revendeur dans les 14 jours suivant la réception de la cabine. Touche



Une deuxième personne doit être disponible pour vous aider.
En outre, nous recommandons de prépercer les trous pour les vis.



Contrôle de l'angle droit :

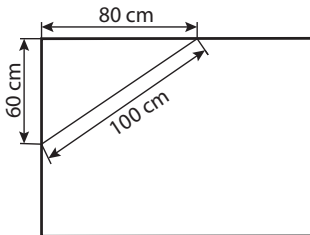

Manipulez le verre avec soin : Faire particulièrement attention avec les bords de la vitre ; en cas de choc, le verre trempé peut se briser en petits morceaux. Placez un rembourrage de protection (par ex., un emballage en carton) sous le bord de la vitre.

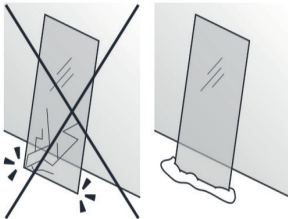

3.1. Outils requis



Tournevis



Mètre ruban



Perceuse



Foret hélicoïdal



Cutter



Niveau à bulle



Crayon à papier



Escabeau

3.2. Entretien et nettoyage

- Le sauna doit être nettoyé au moyen d'un chiffon humide. N'utilisez que de l'eau chaude, pas de détergent.
- Si le sauna n'est pas utilisé pendant une période prolongée, nous recommandons de chauffer la cabine une fois par mois.

3.3. Élimination



Éliminez les matériaux d'emballage conformément aux directives en vigueur relatives à l'élimination.



4. Illustrations de montage de la cabine

Les illustrations se trouvent après les dernières langues

Manuale d'uso

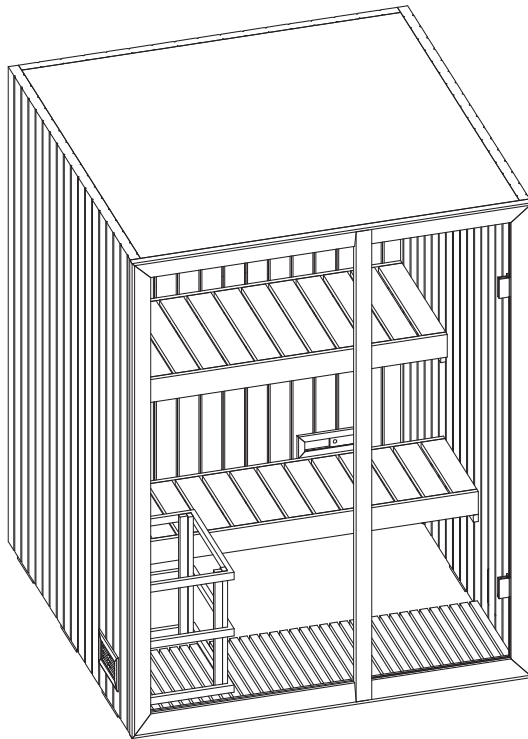

IT

Sauna a elementi

Onni Sauna (1-053-080)

Indice

1. Informazioni sul presente manuale	3
2. Descrizione del prodotto	4
2.1. Specifiche tecniche	4
2.2. Pianta	4
2.3. Dotazione	5
2.4. Elenco dei pezzi	6
3. Preparazione per il montaggio	7
3.1. Attrezzi necessari	7
3.2. Manutenzione e pulizia	8
3.3. Smaltimento	8
4. Figure di montaggio cabina	9

1. Informazioni sul presente manuale

Leggere attentamente le presenti istruzioni di montaggio e d'uso e conservarle vicino alla cabina a infrarossi. Così facendo è possibile controllare in ogni momento le informazioni sulla sicurezza e sull'utilizzo.



Le presenti istruzioni di montaggio e d'uso si trovano anche nell'area di download della nostra pagina web all'indirizzo: www.sentiotec.com/downloads.

Indicazioni importanti:

- Prima di iniziare i lavori, controllare in base all'elenco dei pezzi se tutti i singoli componenti sono stati effettivamente forniti. Se eccezionalmente dovessero mancare dei singoli componenti, contattare il proprio fornitore entro 14 giorni dal ricevimento della cabina.
- L'ambiente in cui la cabina della sauna viene montata deve essere asciutto e garantire la circolazione dell'aria richiesta.
- Il pavimento deve essere orizzontale e uniforme, preferibilmente in pietra o piastrelle.
- Per i lavori di montaggio della cabina è necessaria un'altezza minima libera di 230 cm.
- Mantenere una distanza minima dalle pareti di 5 cm.
- I componenti in legno da utilizzare all'interno non devono essere trattati con impregnante.
- Per il montaggio è richiesto l'aiuto di una seconda persona.
- Il legno è un prodotto naturale che può gonfiarsi, ritirarsi o deformarsi anche se immagazzinato correttamente. In fase di montaggio potrebbe quindi essere necessario applicare una certa forza.

Tutte le connessioni a vite devono essere preforate.

Attenzione!

Il collegamento elettrico deve essere eseguito da elettricisti specializzati o da persone con una qualifica simile.

2. Descrizione del prodotto

2.1. Specifiche tecniche

Materiale della cabina	Obeche
Dimensioni cabina (L x L (profondità) x A)	1600 x 1600 x 2000 mm
Potenza di riscaldamento stufa consigliata	7,5 - 9 kW

2.2. Pianta

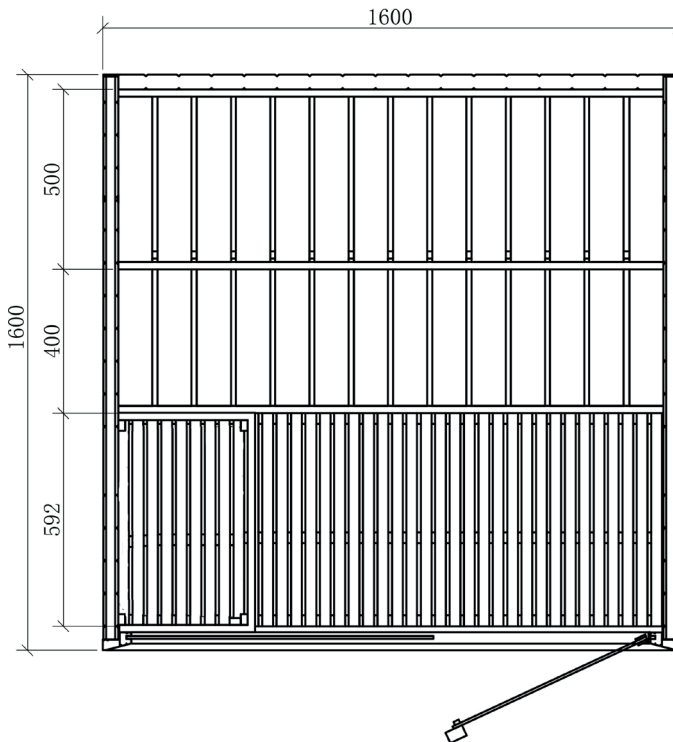

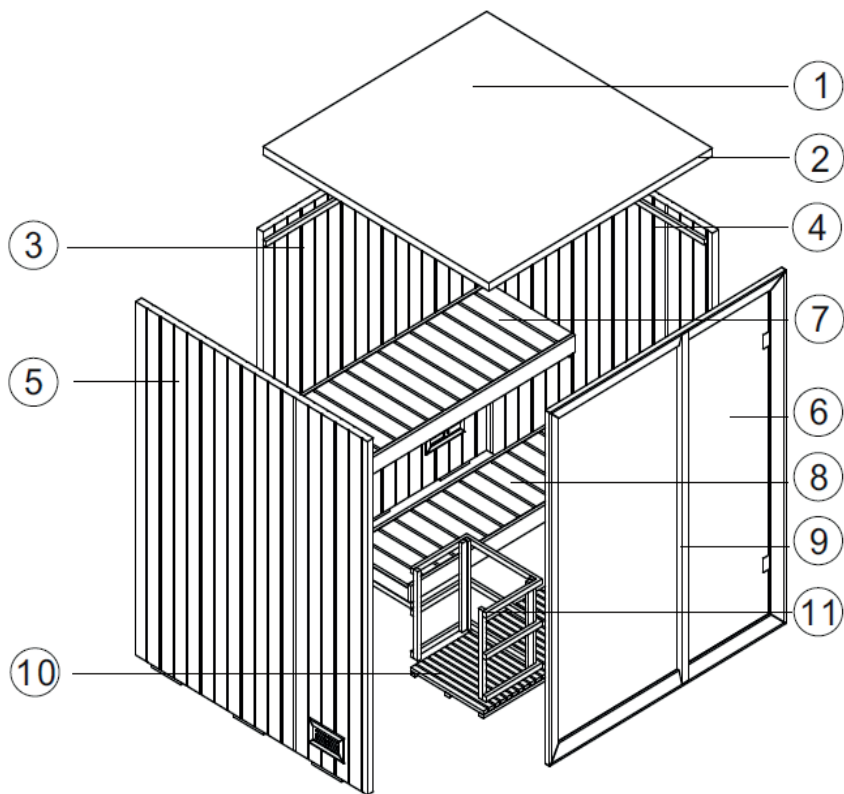

2.3. Dotazione



2.4. Elenco dei pezzi

N.	NOME	DIMENSIONI	PEZZI
1	Copertura elemento tetto	1504 x 1504 x 5 mm	1
2	Elemento tetto	1504 x 1504 x 63 mm	1
3	Pannello posteriore	1507 x 2000 x 56 mm	1
4	Pannello laterale destro	1570 x 2000 x 46 mm	1
5	Pannello laterale sinistro	1570 x 2000 x 46 mm	1
6	Vetro anteriore	1600 x 2000 x 67 mm	1
7	Panca superiore	1505 x 500 x 95 mm	2
8	Panca inferiore	1505 x 500 x 95 mm	1
9	Maniglia porta	1960 x 80 x 32 mm	1
10	Griglia di fondo	1505 x 650 x 60 mm	1
11	Griglia di protezione stufa	580 x 420 x 500 mm	1
12	Lampada		1
13	Griglia di fondo		1

Materiale di montaggio

		
Φ 4 x 35	Φ 4 x 45	Φ 4 x 35
12 pz.	22 pz.	6 pz.

3. Preparazione per il montaggio

Prima di iniziare i lavori, controllare in base all'elenco dei pezzi se tutti i singoli componenti sono stati effettivamente forniti. Se eccezionalmente dovessero mancare dei singoli componenti, contattare il proprio fornitore entro 14 giorni dal ricevimento della cabina. Tasto



Per il montaggio è richiesto l'aiuto di una seconda persona. Raccomandiamo anche di preforare i fori per le viti.



Verifica dell'ortogonalità:

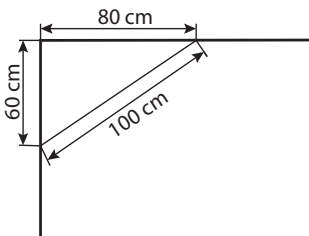

Maneggiare il vetro con cura: particolare attenzione deve essere prestata ai bordi del vetro - il vetro temprato può frantumarsi in piccoli pezzi in caso di impatto. Inserire un cuscino di protezione (ad es: scatola di cartone) sotto il bordo del vetro.

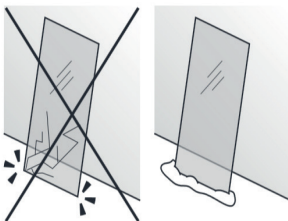

3.1. Attrezzi necessari



Cacciavite



Metro a nastro



Trapano



Trapano a punta elicoidale



Taglierina



Livella a bolla



Matita



Scala a libro

3.2. Manutenzione e pulizia

- La sauna deve essere pulita con un panno umido. Utilizzare solo acqua calda senza detersivi.
- Se la sauna non viene utilizzata per un tempo prolungato, si consiglia di riscaldare la cabina una volta al mese.

3.3. Smaltimento



Smaltire i materiali dell'imballaggio conformemente alle normative sullo smaltimento vigenti.



4. Figure di montaggio cabina

Le figure sono riportate dopo l'ultima lingua

4.

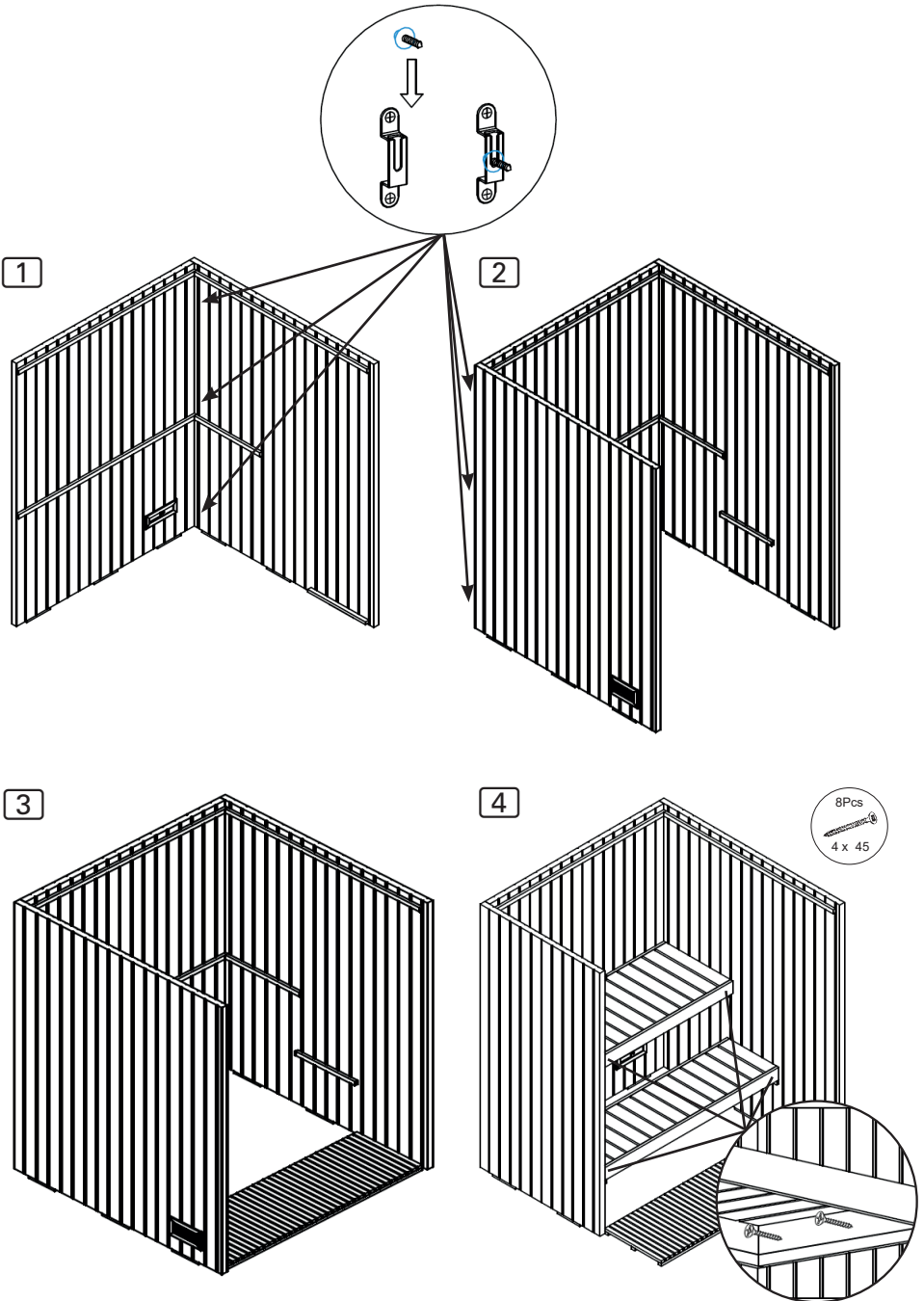

5

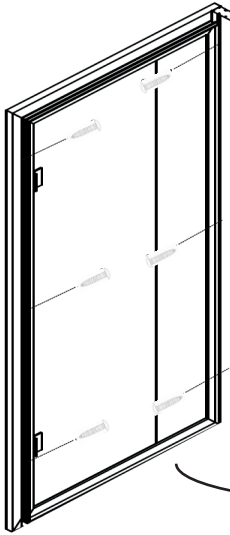

6

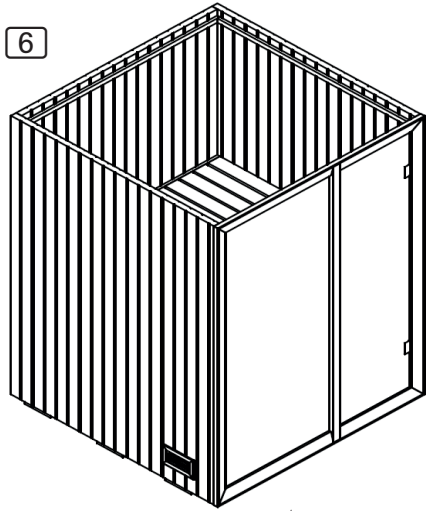

7

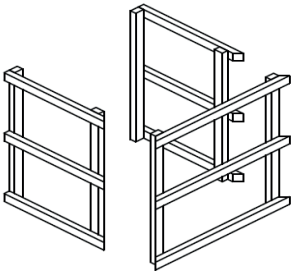

9

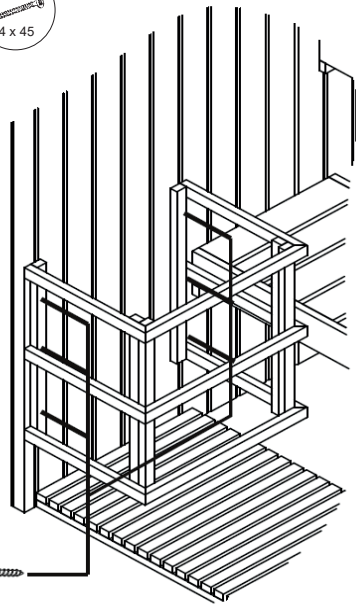

8

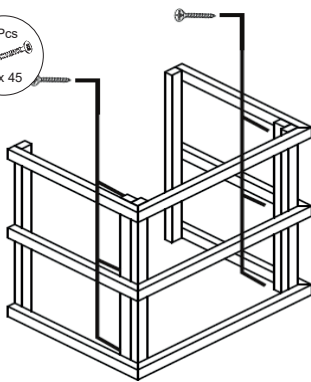

10

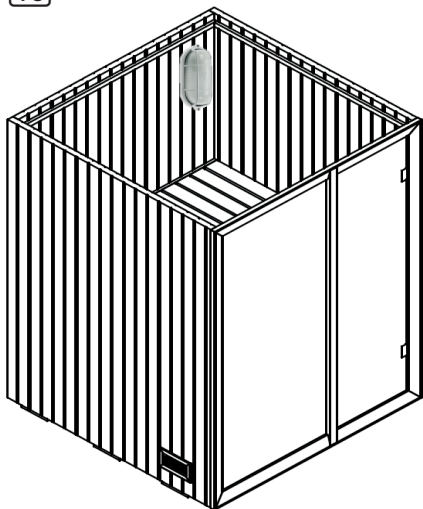

11

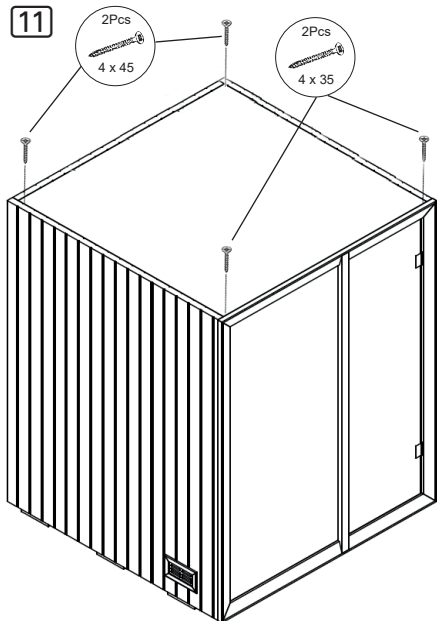

12

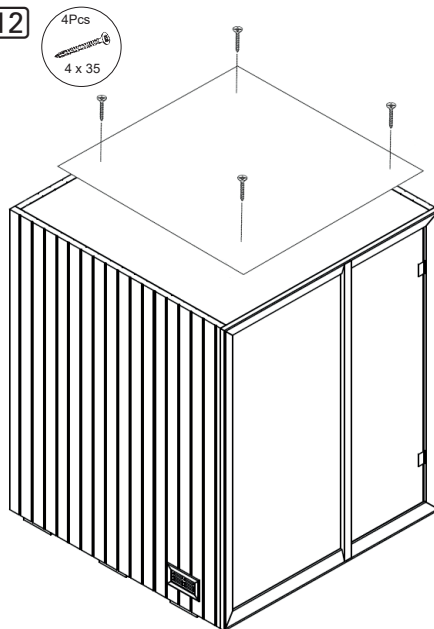



sentiotec GmbH | Division of Harvia Group | Wartenburger Straße 31, A-4840 Vöcklabruck
T +43 (0) 7672/22 900-50 | F -80 | info@sentiotec.com | www.sentiotec.com